



# POWERED PARACHUTE FLYING HANDBOOK



# **Powered Parachute Flying Handbook**

**2007**

**U.S. DEPARTMENT OF TRANSPORTATION  
FEDERAL AVIATION ADMINISTRATION**  
Flight Standards Service



## **Preface**

The *Powered Parachute Flying Handbook* is designed as a technical manual for applicants who are preparing for a powered parachute category rating and for currently certificated powered parachute pilots who wish to improve their knowledge. Certificated flight instructors will find this handbook a valuable training aid, since detailed coverage of emergency procedures, components and systems, aerodynamics, powerplants, ground operations, flight maneuvers, airport operations, and aeronautical decision making is included. Topics, such as navigation and communication, use of flight information publications, and regulations are available in other Federal Aviation Administration (FAA) publications.

This handbook conforms to pilot training and certification concepts established by the FAA. There are different ways of teaching, as well as performing flight procedures and maneuvers, and many variations in the explanations of aerodynamic theories and principles. This handbook adopts a selective method and concept of flying powered parachutes. The discussion and explanations reflect the most commonly used practices and principles. Occasionally the word “must” or similar language is used where the desired action is deemed critical. The use of such language is not intended to add to, interpret, or relieve a duty imposed by Title 14 of the Code of Federal Regulations (14 CFR).

It is essential for persons using this handbook to also become familiar with and apply the pertinent parts of 14 CFR, the *Aeronautical Information Manual* (AIM), and the *Pilot’s Handbook of Aeronautical Knowledge* (FAA-H-8083-25), all of which are available online at [www.faa.gov](http://www.faa.gov). Performance standards for demonstrating competence required for pilot certification are prescribed in the appropriate powered parachute practical test standard (PTS).

The current Flight Standards Service airman training and testing material and subject matter knowledge codes for all airman certificates and ratings can be obtained from the FAA web site [www.faa.gov](http://www.faa.gov).

The FAA greatly acknowledges the valuable assistance provided by many individuals and organizations throughout the aviation community whose expertise contributed to the preparation of this handbook.

This handbook may be purchased from the Superintendent of Documents, U.S. Government Printing Office (GPO), Washington, DC 20402-9325, or from GPO’s web site.

<http://bookstore.gpo.gov>

This handbook is also available for download, in pdf format, from the Regulatory Support Division’s (AFS-600) web site.

[http://www.faa.gov/about/office\\_org/headquarters\\_offices/avs/offices/afs/afs600](http://www.faa.gov/about/office_org/headquarters_offices/avs/offices/afs/afs600)

This handbook is published by the U.S. Department of Transportation, Federal Aviation Administration, Airmen Testing Standards Branch, AFS-630, P.O. Box 25082, Oklahoma City, OK 73125.

Comments regarding this publication should be sent, in email form, to the following address.

[AFS630Comments@faa.gov](mailto:AFS630Comments@faa.gov)

Grateful acknowledgment is extended to the contributors of photography for this handbook. Contained throughout the book are photographs by Paul Hamilton of Adventure Productions; Jim Byers of Magazine & Design, Inc.; Destination Flight Inc.; and Lowell Farrand; additional cover and inside design photography by Steve Russell.

# CONTENTS

## CHAPTER 1—Introduction to the Powered Parachute

History of the Powered Parachute.....	1-1
Powered Parachute Terms .....	1-2
Introduction to the Powered Parachute .....	1-2
Powered Parachute Pilot Certificate	
Eligibility Requirements .....	1-2
Aeronautical Decision Making (ADM) .....	1-4
Resource Management.....	1-4
Use of Checklists .....	1-5
Situational Awareness .....	1-5
Stress Management .....	1-5
Medical Factors Related to the PPC .....	1-5
Alcohol.....	1-6
Anxiety.....	1-6
Carbon Monoxide Poisoning .....	1-6
Dehydration.....	1-6
Drugs.....	1-6
Middle Ear and Sinus Problems.....	1-6
Fatigue.....	1-7
Hyperventilation.....	1-7
Hypoxia.....	1-7
Motion Sickness .....	1-7
Scuba Diving.....	1-8
Spatial Disorientation.....	1-8
Stress .....	1-8
Stroke and Heart Attack .....	1-8
Medical Summary —	
“The Bottom Line” .....	1-9

## CHAPTER 2—Aerodynamics of Flight

Aerodynamic Terms .....	2-1
Powered Parachute Wing Pressurization	
and Flexibility .....	2-3
Forces in Flight .....	2-4
Lift.....	2-5
Drag.....	2-6
Weight .....	2-7
Thrust .....	2-7
Center of Gravity .....	2-8
Axes of Rotation .....	2-9
Ground Effect.....	2-9
Moments .....	2-9
Thrust Line Moments.....	2-10

Gravity Moment.....	2-10
Wing Attachment to Cart .....	2-10
Stability .....	2-12
PPC Angle of Attack Characteristics .....	2-12
Normal Flying Conditions .....	2-12
Flaring Increases Angle of Attack.....	2-13
Porpoising Creates Variations in AOA.....	2-14
Stalls: Exceeding the Critical	
Angle of Attack .....	2-14
Turning Effect .....	2-15
Weight, Load and Speed Changes.....	2-15
PPC Aerodynamics Summary.....	2-16

## CHAPTER 3—Components and Systems

The Airframe .....	3-1
Center of Gravity Adjustments .....	3-2
Multiple Attachment Points Bracket .....	3-3
Center of Gravity Adjuster Tubes .....	3-3
Instrument Panel .....	3-3
Additional Equipment.....	3-4
Electrical System .....	3-4
The Steering Bars.....	3-5
Wings and Components .....	3-5
Risers.....	3-7
The Fuel Tank .....	3-7
Throttle System.....	3-8
The Powerplant .....	3-8
The Propeller.....	3-8
Axle and Wheel Assembly.....	3-9

## CHAPTER 4—Powerplants

Reciprocating Engines .....	4-1
Two-Stroke Engines.....	4-1
Two-Stroke Process.....	4-1
Four-Stroke Engines .....	4-4
Exhaust Systems .....	4-4
Two-Stroke Tuned Exhaust Systems.....	4-4
Four-Stroke Engine Exhaust Systems.....	4-4
Two-Stroke Engine Warming.....	4-4
Four-Stroke Engine Warming .....	4-5
Gearboxes .....	4-5
Centrifugal Clutch .....	4-6
Propeller.....	4-6

Fixed-Pitch Propeller .....	4-6
Ground Adjustable-Pitch Propeller .....	4-6
Induction Systems .....	4-6
Carburetor Systems .....	4-6
Two-Stroke Carburetor Jetting .....	4-7
Four-Stroke Mixture Settings .....	4-8
Carburetor Icing .....	4-8
Fuel Injection Systems .....	4-8
Ignition System .....	4-9
Combustion .....	4-9
Fuel Systems .....	4-10
Fuel Pumps .....	4-10
Fuel Plunger Primer .....	4-10
Choke .....	4-10
Fuel Bulb Primer .....	4-10
Fuel Gauges .....	4-11
Fuel Filter .....	4-11
Fuel .....	4-11
Fuel Contamination .....	4-12
Bad Gasoline .....	4-12
Refueling Procedures .....	4-12
Mixing Two-Stroke Oil and Fuel .....	4-13
Starting System .....	4-13
Oil Systems .....	4-13
Engine Cooling Systems .....	4-13

## **CHAPTER 5—Preflight and Ground Operations**

Get Ready to Fly .....	5-1
Trailerling .....	5-1
Where to Fly .....	5-2
Weather .....	5-3
Weight and Loading .....	5-3
The Preflight Checklist .....	5-5
Certificates and Documents .....	5-5
Visual Inspection .....	5-6
Cart Inspection .....	5-6
Fuel and Oil .....	5-8
Powerplant Inspection .....	5-8
Engine Starting .....	5-9
Engine Warm-Up .....	5-10
Taxiing .....	5-10
Wing Inspection .....	5-12
Line Tangles, Twists, and Line-Overs .....	5-14
Line Twists .....	5-15
Line-Overs .....	5-16

Preparing for Takeoff .....	5-16
After Landing .....	5-16
Clearing the Runway .....	5-17
Parking .....	5-17
Postflight .....	5-17
Packing the Wing .....	5-17

## **CHAPTER 6—Basic Flight Maneuvers**

The Four Fundamentals .....	6-1
Flight Controls .....	6-1
Throttle .....	6-1
Claring Turns .....	6-2
Turning the Powered Parachute .....	6-2
Feel of the PPC .....	6-2
Attitude Flying .....	6-3
Straight-and Level Flight .....	6-3
Level Turns .....	6-5
Climbing and Climbing Turns, Descents and Descending Turns .....	6-7
Gliding .....	6-8
Wing Trim .....	6-8

## **CHAPTER 7—Takeoffs and Departure Climbs**

Terms and Definitions .....	7-1
Laying Out the Wing .....	7-1
The Inverted Method .....	7-1
The Stacked (or Accordion) Method .....	7-2
Cockpit Management .....	7-2
Before Takeoff Check .....	7-3
Start the Engine/Initial Rollout .....	7-3
Wing Inflation and Kiting .....	7-3
Normal Takeoff .....	7-5
Takeoff Roll .....	7-5
Rotation .....	7-5
Lift-Off .....	7-5
Initial Climb .....	7-5
Centering the Wing .....	7-6
Encourage Cell Openings .....	7-6
“Lock-out” Avoidance .....	7-6
Crosswind Takeoff .....	7-6
Positioning the Cart .....	7-6
Wing Inflation and Kiting .....	7-6
Takeoff Roll .....	7-7
Lift-Off .....	7-7
Initial Climb .....	7-7

Rejected Takeoff/Engine Failure.....	7-7
Runway Surface and Gradient .....	7-8
Takeoff Performance .....	7-8
Noise Abatement .....	7-9

**CHAPTER 8—Airspace Classification and Requirements**

Controlled Airspace .....	8-1
Class A Airspace .....	8-1
Class B Airspace .....	8-2
Class C Airspace .....	8-3
Class D Airspace .....	8-3
Class E Airspace .....	8-3
Uncontrolled Airspace: Class G Airspace .....	8-4
Special Use Airspace.....	8-4
Prohibited Areas.....	8-4
Restricted Areas .....	8-4
Warning Areas.....	8-4
Military Operation Areas .....	8-5
Alert Areas .....	8-5
Controlled Firing Areas.....	8-5
Other Airspace Areas .....	8-5
Airport Advisory Areas.....	8-5
Military Training Routes.....	8-5
Temporary Flight Restrictions .....	8-5
Parachute Jump Areas .....	8-5
Published VFR Routes.....	8-6
Terminal Radar Service Areas.....	8-6
National Security Areas .....	8-6
Flight Over Charted U.S. Wildlife Refuges, Parks, and Forest Service Areas.....	8-6
Powered Parachute Operations .....	8-6
PPC and Air Traffic Control.....	8-6
Navigating the Airspace.....	8-7

**CHAPTER 9—Ground Reference Maneuvers**

Purpose and Scope .....	9-1
Maneuvering by Reference to Ground Objects .....	9-1
Drift and Ground Track Control .....	9-2
Rectangular Course .....	9-4
S-Turns Across a Road.....	9-6
Turns Around a Point .....	9-8

**CHAPTER 10—Airport Traffic Patterns**

Airport Traffic Patterns and Operations .....	10-1
Standard Airport Traffic Patterns .....	10-2

**CHAPTER 11—Approaches and Landings**

Normal Approach and Landing.....	11-1
Base Leg.....	11-1
Final Approach.....	11-2
Estimating Height and Movement .....	11-3
Roundout.....	11-3
Wing Control.....	11-4
Touchdown.....	11-5
After-Landing Roll.....	11-6
Stabilized Approach Concept.....	11-7
Go-Arounds (Rejected Landings) .....	11-8
Turbulent Air Approach and Landing .....	11-9
Emergency Approach and Landings (Simulated).....	11-9
Faulty Approaches and Landings.....	11-11
Low Final Approach.....	11-11
High Final Approach.....	11-11
Use of Power.....	11-11
High Roundout.....	11-11
Bouncing During Touchdown .....	11-12
Hard Landing .....	11-12
Wing Blowing Over After Touchdown ....	11-13

**CHAPTER 12—Night, Abnormal, and Emergency Procedures**

Night Operations and the Powered Parachute.....	12-1
Emergency Situations .....	12-1
Accidents.....	12-2
Potential Hazards of the Standing PPC.....	12-2
Restricted Lines During the Takeoff Roll .....	12-3
Entangled or Embedded Lines .....	12-3
Lines Caught Under a Wheel .....	12-3
A Wing Wall.....	12-3
A Wing Lock-Out.....	12-3
Wing Not Centered Overhead.....	12-4
The Cart Turns Over (Roll-Over) .....	12-4
Engine Failure on Climbout.....	12-5
Engine Failure in Flight .....	12-6
Engine Failure in a PPCL.....	12-6
In-Flight Fire.....	12-7



Landing Porpoise .....	12-7
Gust-Induced Oscillations.....	12-8
Cross-Country Flights.....	12-8
Emergency Equipment and Survival Gear.....	12-8
<b>Glossary</b> .....	<b>G-1</b>
<b>Index</b> .....	<b>I-1</b>

# CHAPTER 1

## INTRODUCTION TO THE POWERED PARACHUTE

### History of the Powered Parachute

As early as the 12th century, the Chinese used an umbrella-shape parachute design for recreation. About 300 years later, Leonardo da Vinci blueprinted a pyramid-shaped parachute. In the late 18th century, man jumped from towers and balloons with a parachute. The first parachute jump from an airplane occurred in 1912.

After World War II, sport jumping became a recreational activity. The sport started with round parachutes, ranging in size from 20 to 30 feet in diameter. Parachutes evolved into a steerable, gliding wing smaller than today's rectangular ram-air powered parachute (PPC) wing which is approximately 38 feet wide.

On October 1, 1964, Domina C. Jalbert applied for a patent for his "Multi-Cell Wing" named "Parafoil" (also known as a "ram-air" wing), which was a new parachute design. His ideas were registered as a U.S. patent on November 15, 1966. [Figure 1-1 A] However,

in 1964 Lowell Farrand had already flown a motorized version called "The Irish Flyer" by Nicolaides. [Figure 1-1 B] Farrand was the first person to put an engine on a ram-air inflated parachute wing, starting the evolution of the powered parachute with the Irish Flyer. This wing evolved into today's modern powered parachute canopies, which include rectangular, elliptical, semi-elliptical, and hybrid wings.

The United States (U.S.) government had a number of test programs that used the square parachute as a means to glide spacecraft back to earth or glide payloads dropped out of airplanes to a specific location.

Two-place powered parachutes have years of testing, development, and evolution. Training exemptions to Title 14 of the Code of Federal Regulations (14 CFR) part 103, Ultralight Vehicles, permitted individuals to give instruction in two-place ultralight vehicles, instead of being restricted to vehicles intended for single occupants. [Figure 1-1 C] The Federal Aviation Administration (FAA) allowed ultralight vehicle

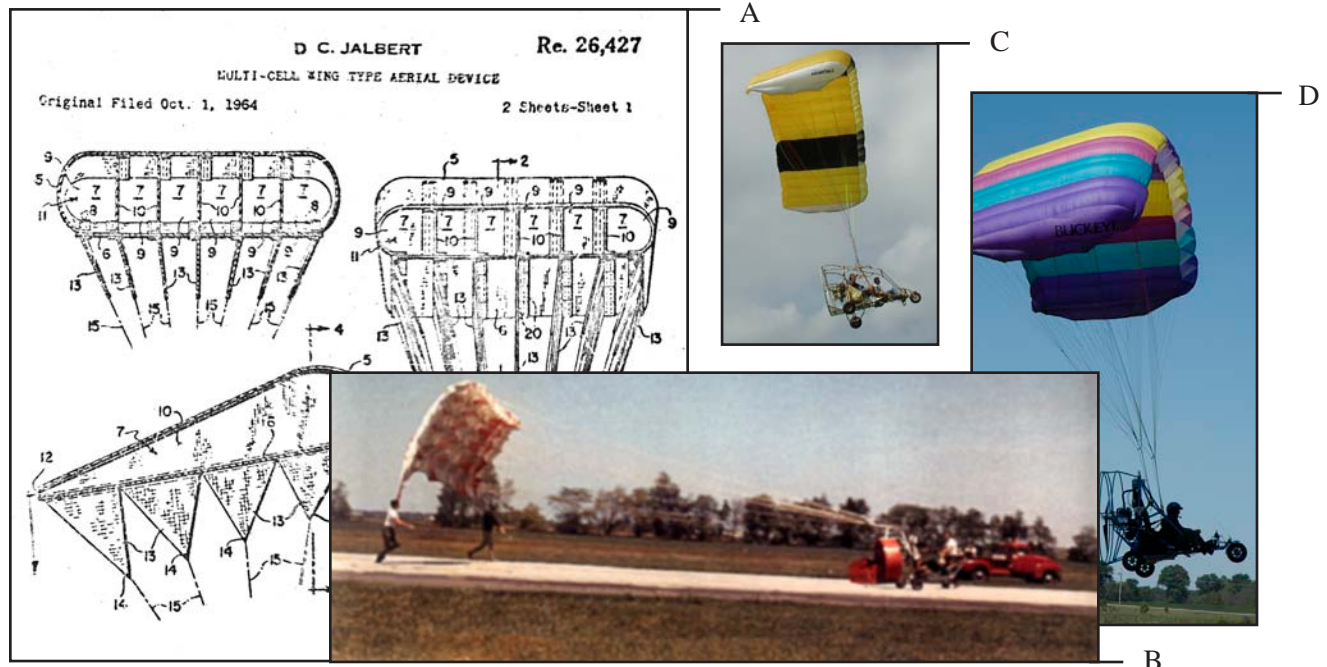
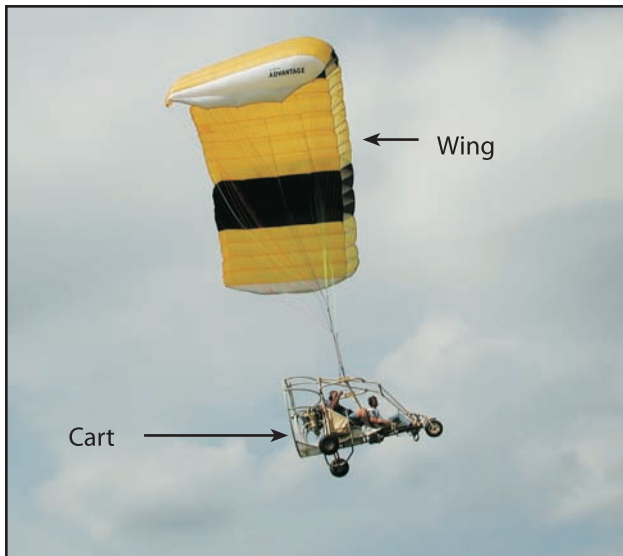

Figure 1-1. The evolution of powered parachutes.



**Figure 1-2. Two-place powered parachute aircraft.**

pilots to train in two-place ultralights until January 31, 2008. After this date, the ultralight vehicle training exemption expires and only N-numbered aircraft may be used in two-place PPC instruction and flight. [Figure 1-1 D]

### Powered Parachute Terms

Different terms have been used throughout the powered parachute community. [Figure 1-2] The terms standardized throughout this book are as follows:

- Powered Parachute – The complete aircraft.
- Cart – The engine and seats, attached by a structure to wheels; may also be referred to as the fuselage, cockpit, chaise, or airframe.
- Wing – Typically a ram-air inflated and pressurized wing including lines that attach to the cart. The wing is not in position to fly until the aircraft is in motion; when not inflated, referred to as a parachute or chute.

## Introduction to the Powered Parachute

The powered parachute is a category of aircraft that flies in a manner unique among light-sport aircraft. Three significant differences separate the PPC from other types of light sport aircraft (LSA): [Figure 1-3]

1. The wing must be inflated and pressurized by ram air prior to each takeoff.
2. The aircraft uses a pendulum configuration, where the cart hangs about 20 feet below the wing, connected via flexible suspension lines.
3. The wing is at a relatively fixed angle with the suspension lines and flies at a relatively constant speed. Other aircraft categories allow pilots to change the speed of the aircraft, but the powered parachute airspeed remains within a very small range.

A powered parachute can be a single place ultralight flying vehicle, a single place light-sport aircraft, or a multi-place light-sport aircraft. The common acronyms for this vehicle/aircraft are PPC (powered parachute), PPCL (powered parachute land) or PPCS (powered parachute sea).

A light-sport aircraft PPC used for sport and private flying must be registered with an FAA N-number, have an airworthiness certificate, a pilot's operating handbook (POH), and/or limitations with a weight and balance document aboard. The aircraft must be maintained properly by the aircraft owner or other qualified personnel and have the aircraft logbooks available for inspection. Dual controls are required in the aircraft for training.

### Powered Parachute Pilot Certificate Eligibility Requirements

You may not act as pilot in command (PIC) of a light-sport aircraft powered parachute unless you hold a pilot certificate with a powered parachute rating issued by the FAA. At this time the only pilot cer-



**Figure 1-3. The powered parachute has some unique operating characteristics as compared to other light-sport aircraft. Left, PPC with inflated wing; middle, weight-shift control aircraft; right, fixed-wing LSA.**

tificates with powered parachute ratings are Student, Sport and Private. The FAA is empowered by the U.S. Congress to promote aviation safety by prescribing safety standards for pilots and the other civil aviation programs. The Code of Federal Regulations (CFRs), formerly referred to as Federal Aviation Regulations (FARs), are one of the primary means of conveying these safety standards.

Title 14 CFR, part 61 specifies the requirements to earn a pilot certificate. This regulation also states the pilot applicant must be able to read, speak, write, and understand the English language. The FAA Practical Test Standards (PTS) establish the standards for the knowledge and skills necessary for the issuance of a pilot certificate. [Figure 1-4] You should reference both these documents to understand the knowledge, skills and experience required to obtain a pilot certificate to fly a powered parachute.

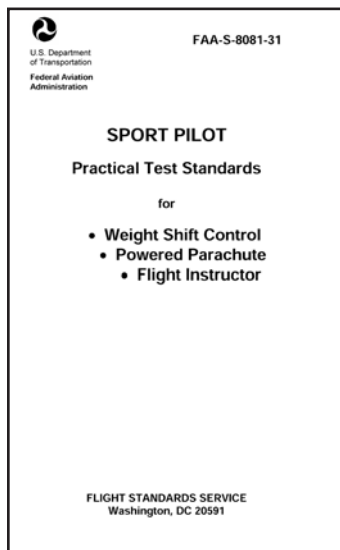

**Figure 1-4. The PTS is used to test the knowledge and skill of a pilot applicant.**

Pilot applicants must have a valid U.S. driver’s license or a current third-class medical certificate issued under 14 CFR part 67. If you use your valid driver’s license to exercise the privileges of a Sport Pilot certificate, then you must also adhere to any restrictions on that driver’s license. You must hold a current third-class medical certificate to exercise the privileges of a Private Pilot certificate.

The process of learning to fly includes a combination of ground training (to include successful completion of the FAA Knowledge Exam) and flight training to include dual flights with a certified flight instructor

(CFI), as well as solo flights under the supervision of your CFI.

To be eligible to fly solo in a PPC, you must be at least 16 years of age and demonstrate satisfactory aeronautical knowledge on a test developed by your instructor. You must have received and logged flight training for the maneuvers and procedures in 14 CFR part 61 for the PPC, as well as demonstrated satisfactory proficiency and safety. Only after all of these requirements are met can your instructor endorse your student pilot certificate and logbook for solo flight.

Once you obtain the required aeronautical knowledge and experience required by 14 CFR part 61, your flight instructor will endorse you to take a practical test (often called a “checkride”) with a sport pilot examiner (SPE) or an FAA inspector. After you’ve demonstrated satisfactory aeronautical knowledge and skill in the Areas of Operation and Tasks outlined in the PTS, this examiner or inspector will issue your temporary (paper) pilot certificate. You will receive a plastic certificate in the mail once the results of the practical test are received by the FAA Registration branch.

A sport pilot is certified to fly a light-sport aircraft. To be eligible for a sport pilot certificate with a powered parachute rating, you must be at least 17 years of age, complete the specific training and flight time requirements described in 14 CFR part 61 subpart J, pass the FAA Knowledge Exam, and successfully complete the practical test.

If you hold at least a private pilot certificate, but not a rating for the category and class of PPC LSA, you can operate the powered parachute with a logbook endorsement and passing a proficiency check. [Table 1] If you hold at least a private pilot certificate with a PPC category and class rating, and have a current

<p><b>Category.</b> A broad classification of aircraft such as airplane, weight-shift control, powered parachute, rotorcraft, glider, lighter-than-air.</p>
<p><b>Class.</b> A classification of aircraft within a category having similar operating characteristics; i.e., powered parachute land, powered parachute sea.</p>
<p><b>Type and make/model are the same.</b> A specific make and basic model of aircraft that does not change its handling or flight characteristics; i.e., Cosmos Phase II, Air Borne Streak, Flight Design CT, Challenger, Quicksilver MX, Drifter, Air Creation GTE, Powrachute Pegasus, Piper J-3 Cub, North Wing Apache, etc.</p>

**Table 1. Definitions with respect to the certification, ratings, privileges, and limitations of airmen.**

third-class medical, then you may operate any PPC LSA in that category and class, and do not need to hold any of the endorsements required by Sport Pilots, nor do you need to comply with the limitations of a Sport Pilot certificate.

Note: If you hold at least a Private pilot certificate, but not a medical certificate, you may operate as a Sport Pilot and must comply with 14 CFR part 61 subpart J.

A Sport Pilot instructor can instruct, endorse logbooks for privileges, and give proficiency check flights in a LSA. To be eligible for a Sport Pilot instructor certificate, you must be at least 18 years of age and hold at least a current and valid Sport Pilot certificate with category and class ratings or endorsements appropriate to the flight instructor privileges sought. You must also pass the Sport Pilot instructor and fundamentals of instructing knowledge exams and meet the experience and knowledge requirements outlined in 14 CFR part 61.

## **Aeronautical Decision Making (ADM)**

Your current attitude or mindset is something you, as PIC, must constantly be alert to in order to maintain your safety and that of the aircraft, your passenger and the general public on the ground. To accomplish sound aeronautical decision making (ADM), you must first be aware of your limitations and well-being (physical and psychological health), even before beginning the first preflight routine. While technology is constantly improving equipment and strengthening materials, safe flight comes down to the decisions made by the human pilot prior to and during flight.

The well-being of the pilot is the starting point for the decision making processes that will occur while in control of the aircraft. Just as physical fatigue and illness will directly affect your judgment, so too will your attitude management, stress management, risk management, personality tendencies, and situational awareness. Hence, it is the awareness of your human factors and the knowledge of the related corrective action that will not only improve the safety of operating a powered parachute, but will also enhance the joy of flying. See Chapter 16 of the *Pilot's Handbook of Aeronautical Knowledge* (FAA-H-8083-25) to learn the decision-making process, risk management techniques, and hazardous attitude antidotes you should use in all your flight operations.

The phrase “pilot error” points to the human factors which have caused an incident or accident, including the pilot’s failure to take appropriate action. Typical-

ly, it is not a single decision or indecision that leads to an accident, but most likely it is a chain of error-related factors. This inadequate action and poor judgment path is referred to as the human “error chain.” You only need to be aware of a situation and break one link in this error chain to improve the outcome of a sequence of events and return to safe and secure flight.

A good instructor will immediately begin teaching ADM when the student has the ability to confidently control the powered parachute during the most basic maneuvers. During a proficiency or practical test, the instructor or examiner will be evaluating the applicant’s ability to use satisfactory ADM practices as the pilot determines risks and coordinates safe procedures.

## **Resource Management**

Pilots must make effective use of single-pilot resource management (SRM): human resources (pilot, passenger, maintenance personnel, and the weather briefer, as applicable), hardware (equipment), and information. It is similar to crew resource management (CRM) procedures that are being emphasized in multi-crew-member operations except only one crewmember (the pilot) is involved. Resource management is one way of optimizing the risk elements (the pilot, the aircraft, the environment, and the type of flight operation). This ability to manage the resources available to you is as critical to the successful outcome of the flight as your skills and procedures as a pilot.

Light-sport aircraft are flown by a single pilot. Nonetheless, there are numerous resources available to that pilot. For instance, even though the passenger is not a pilot, he or she can be asked to assist with scanning the skies and a possible landing location during an emergency. Your knowledge, skills, and consistent use of a checklist are also valuable resources. External resources for the powered parachute pilot include those that can assist with Notices to Airmen (NOTAMs) and weather information. These resources can include Automated Weather Observing System (AWOS), Automated Surface Observing System (ASOS), Hazardous Inflight Weather Advisory Service (HIWAS), and Flight Service Stations (FSS) 800-WX-BRIEF.

## Use of Checklists

Checklists have been the foundation of pilot standardization and cockpit safety for many years. The checklist is an aid to the fallible human memory and helps to ensure that critical safety items are not overlooked or forgotten. However, checklists are of no value if the pilot is not committed to their use. Without discipline and dedication in using a checklist, the odds favor the possibility of an error.

The importance of consistent use of checklists cannot be overstated in pilot training. A major objective in primary flight training is to establish habitual patterns that will serve the pilot well throughout their entire flying career. The flight instructor must promote a positive attitude toward the use of checklists, and the student pilot must realize its importance. At a minimum, prepared checklists should be referenced for the following phases of flight:

- Preflight Inspection
- Before Engine Start
- Engine Starting
- Before Kiting and Taxiing the Wing
- During the Takeoff Roll
- After Takeoff
- Before Landing
- After Landing
- Engine Shutdown
- Postflight Inspection and Securing

Due to the open nature of the cart, you should secure your checklist to ensure it does not get blown through the prop. It should be attached to something (a kneeboard strapped to your leg, the instrument panel, etc.) to eliminate the possibility of it being blown away, yet remaining visible and easy to use.

## Situational Awareness

Situational awareness is the accurate perception and understanding of all the factors that affect the powered parachute, pilot, passenger, environment and type of operation comprising a given situation. Maintaining situational awareness requires an understanding of the relative significance of these factors and their future impact on the flight. When situationally aware, the pilot has an overview of the total operation and is not fixated on one perceived significant factor. In addition, an awareness must be maintained of the environmental conditions of the flight, such as spatial orientation of the PPC, and its relationship to terrain, traffic, weather, and airspace.

To maintain situational awareness, all of the skills involved in aeronautical decision making are used. For example, an accurate perception of pilot fitness can be achieved through self-assessment and recognition of hazardous attitudes. Establishing a productive relationship with pattern traffic and traffic control can be accomplished by effective resource use.

## Stress Management

Stress is part of the human process. A certain amount of stress can be good as it keeps a person alert and tends to prevent complacency. However, the effects of stress are cumulative. If not coped with adequately, eventually the stress may result in an intolerable burden with negative psychological and perhaps physical consequences. Performance generally increases with the onset of stress, peaks, and then begins to fall off rapidly as stress levels exceed a person's ability to cope. The ability to make effective decisions during flight is likely to be impaired by stress. Hence, the ability to reduce high levels of cockpit stress will have a direct correlation to aircraft safety.

Stress management in the aircraft begins by making an assessment of stress in all areas of your life. There are several techniques to help manage the accumulation of life stresses and prevent stress overload. For example: set realistic goals; manage time more effectively; include relaxation time in a busy schedule; maintain a weekly program of physical fitness; and maintain flight proficiency. If stress does strike in flight, you should try to relax, take a deep breath, and then calmly begin to think rationally through the resolution and decision process.

## Medical Factors Related to the PPC

Medical factors, regardless of their severity, should never be dismissed without at least a cursory consideration. Even a toothache or the common cold can be detrimental to a safe flight, especially when drugs of any sort, even non-prescription, are taken before the flight.

Most medical issues can be easily handled in a PPC, but a few can have severe influences on the safety of the flight. For instance, medical situations might cause the muscles of the limbs to tighten or go into a spasm. These scenarios can be deadly, such as when the legs are pressing against a steering bar during a seizure.

The following medical factors are not listed by importance, but by alphabetical order for easy reference.

## Alcohol

Alcohol directly affects the brain and can do so very quickly. Some myths still surround alcohol: drinking coffee can dissipate the effects, or taking a cold shower will “sober” you up quickly. The fact is that becoming intoxicated is determined by the amount of alcohol in the bloodstream. Once consumed, alcohol can enter the bloodstream—and therefore the brain—in as quickly as 10 minutes. Once in the brain, motor skills immediately begin to deteriorate. The common aviation saying is “8 hours bottle to throttle.” However, depending on the metabolism of the individual, it may be twice as long before some humans can dissipate the negative effects of alcohol. Even in small amounts, alcohol can affect your motor skills, diminish your mental reasoning, decrease your sense of responsibility, and shorten your memory. In addition, the effect of alcohol is greatly multiplied when gaining altitude.

FAA regulations state that no one may act as a crewmember if they have consumed alcohol within 8 hours of flight, are under the influence of alcohol, are using any drug affecting their faculties contrary to safety, or if they have a blood alcohol level greater than 0.04 percent. Part 61 also states that refusal to take a drug or alcohol test, a conviction for a violation of any Federal or State statute relating to the operation of a motor vehicle (that’s right—a car) while under the influence of alcohol or a drug, or failure to provide a written report of each motor vehicle action to the FAA (not later than 60 days after the motor vehicle action) are grounds for:

1. Denial of an application for any certificate, rating, or authorization for a period of up to 1 year after the date of such refusal; or
2. Suspension or revocation of any certificate, rating, or authorization.

## Anxiety

Anxiety can cause humans to act in unpredictable and negative ways. If your future is uncertain or an unpredictable event occurs that forces you into an unknown path, anxiety can appear. Self realization and learned confidence through knowledge and practice are the best ways to prepare for possible anxiety attacks.

## Carbon Monoxide Poisoning

Carbon monoxide (CO) poisoning is typically not a factor in a powered parachute, as the engine is behind the pilot in the typical PPC pusher configuration. However, since CO is a colorless, odorless, and tasteless gas, you need to be alert to exposure prior to flight.

## Dehydration

Dehydration is the critical loss of water from the body. The first noticeable effect of dehydration is fatigue. A powered parachute pilot is particularly susceptible to dehydration, as they normally fly in an open cart, often exposed for hours to the direct rays of the sun. If dehydration occurs and water is not replaced, fatigue will progress to dizziness, weakness, nausea, tingling of hands and feet, abdominal cramps, and extreme thirst. It is highly recommended for PPC pilots, especially those that fly in desert regions, to carry an ample supply of water and to drink regularly, regardless of whether or not you feel thirsty. When you begin to feel thirsty, the beginning stages of dehydration have already started.

## Drugs

One of the biggest misconceptions is the myth that over-the-counter drugs may be taken before a flight. A non-prescription drug does not mean it is free of side effects that may affect your faculties. Consult a physician about mixing flying with any drugs. Many medications such as tranquilizers, sedatives, strong pain relievers, and cough-suppressants have primary effects that may impair judgment, memory, alertness, coordination, vision, and the ability to make calculations. Others, such as antihistamines, blood pressure drugs, muscle relaxants, and agents to control diarrhea and motion sickness, have side effects that may impair the same critical functions.

Pain killers or over-the-counter analgesics, such as Aspirin (acetylsalicylic acid), Tylenol (acetaminophen), and Advil (ibuprofen), have few side effects when taken in the correct dosage. Flying is usually not restricted when taking these drugs. However, flying is almost always precluded while using prescription analgesics such as Darvon, Percodan, Demerol, and codeine, since these drugs may cause side effects such as mental confusion, dizziness, headaches, nausea, and vision problems.

Regulations prohibit pilots from performing duties while using any medication that affects their abilities in any way contrary to safety. The safest rule is not to fly while taking any medication, unless approved to do so by an Aviation Medical Examiner (AME).

## Middle Ear and Sinus Problems

As powered parachutes are not pressurized, atmospheric pressure changes will affect pilots flying to high altitudes. Atmospheric pressure decreases as you ascend, and increases as you descend. The pilot’s in-

ner ear does not always have a means to adjust its contained air pressure to the outside or ambient air pressure. When the pressure in the inner ear is anything different than the outside air pressure, the result can be pain as the eardrum bulges outward or inward in reaction to the pressure differential.

To resolve this condition you need to equalize the pressure via the eustachian tube that leads from the middle ear to your mouth. One method of doing this is to pinch your nostrils shut, close your mouth and lips, and blow slowly and gently in the mouth and nose. This procedure forces air up the eustachian tube into the middle ear. If you have a cold, an ear infection, or sore throat, you may not be able to equalize the pressure in your ears. A flight in this condition can be extremely painful, as well as damaging to your eardrums. Hence, flying is not recommended if you have an illness with symptoms around the ears, nose or mouth.

### **Fatigue**

Fatigue is frequently associated with pilot error. Many pilots do not want to readily admit that fatigue could be a detrimental factor to their flight skills. Some of the effects of fatigue include degradation of attention, degradation of concentration, impaired coordination, and decreased ability to communicate. These factors can seriously influence a pilot's ability to make effective decisions.

Whether you experience physical fatigue from a lack of sleep or physical work, or mental fatigue from stress, you should consider staying grounded.

### **Hyperventilation**

Hyperventilation occurs when you are experiencing emotional stress, fright, or pain, and your breathing rate and depth increase although the carbon dioxide (CO<sub>2</sub>) is already at a reduced level in the blood. The result is an excessive loss of carbon dioxide from your body, which can lead to unconsciousness due to the respiratory system's overriding mechanism to regain breathing control.

The typical symptoms need to be recognized and should not be confused with hypoxia, which shares some indicators. Lightheadedness, feelings of suffocation, and drowsiness can be some of the first signs. Hyperventilation may produce a pale, clammy appearance and muscle spasms compared to the cyanosis and limp muscles associated with hypoxia. As hyperventilation progresses, you may then feel tingling in the extremities, then muscle cramps; cramps

that can become severe and painful. If you don't correct your breathing, your brain will override your consciousness, and cause you to faint, while the brain regains control of your breathing.

Hyperventilation can occur when a pilot feels an excessive amount of stress, fear or anxiety. An unexpected or extreme encounter with a thermal or turbulence may unconsciously increase your breathing rate. These situations and the associated feelings tend to increase the rate and size of breath, which then results in clearing too much CO<sub>2</sub> from the body.

The solution is to relax and slow down your breathing. This can be accomplished by talking or singing out loud, or breathing into a paper bag which keeps fresh oxygenated air from further reducing the CO<sub>2</sub> in your system. Symptoms will rapidly subside after the rate and depth of breathing are brought under control.

### **Hypoxia**

Hypoxia is a lack of oxygen. There are many forms of hypoxia that are beyond the scope and need for discussion in a PPC manual, but the results from oxygen deficiency are the impairment of the functions of the brain and other organs. Symptoms include headache, drowsiness, dizziness, euphoria, and blue fingernails and lips.

The most likely cause for a PPC pilot to experience symptoms of hypoxia would be flying too high. Unless you are a private pilot with a powered parachute rating, you need to stay below 10,000 feet where you will have less chance of experiencing hypoxia in a PPC. However, if you are acclimated to sea level conditions and climb above 8,000 feet, you may feel the effects of hypoxia. The longer you stay at altitude, the greater the effects of hypoxia will be. In addition, recent consumption of alcohol, smoking, and some medications will render a pilot more susceptible to disorientation and hypoxia. If you question your condition and consider hypoxia to be a potential problem, you should fly at lower altitudes and/or use supplemental oxygen.

### **Motion Sickness**

Motion sickness, or airsickness, is caused by the brain receiving conflicting messages about the orientation of the body. The inner ear—specifically the vestibular system—is reporting one spatial orientation, and the eyes are communicating a different scenario. This not only causes confusion in your thinking, it may possibly create vertigo or spatial disorientation. It often causes vomiting and a debilitating feeling. Vomiting



is due to a nerve that is connected from the brain to the stomach. When confusion or disagreement occurs between the eyes and the orientating vestibular system, vomiting may erupt.

When symptoms of motion sickness begin, get back on the ground. In the meantime, avoid unnecessary head movements and keep your eyes on the horizon.

As the pilot, you should note if the passenger, who had been talking throughout the flight, gets quiet. You should ask “how are you doing” because getting quiet is sometimes a precursor to feelings of nausea. Inform passengers while still on the ground to let you know if their stomach begins to feel “uneasy.”

Motion sickness can be the result of continued flight stimulation, such as rapid or unexpected turns and swinging through the PPC pendulum. As the pilot, you will find a reduced rate of upset stomachs if you let the passenger know, ahead of time, the flight maneuver you are about to make and avoid abrupt maneuvers.

For new students, anxiety and stress may greatly contribute to motion sickness. However, after a few lessons and some time in the air from the front seat, these feelings/symptoms will usually dissipate.

Medication like Dramamine can be used to prevent motion sickness/nausea in passengers, but since it can cause drowsiness, it is not recommended for the pilot.

### Scuba Diving

Taking a flight, especially a high flight, after a deep scuba dive can have some devastating results. This is because the increased pressure of the water during a dive causes nitrogen to be absorbed into the body tissues and bloodstream. Then, when flying at altitudes of reduced atmospheric pressure, the nitrogen will move out of the bloodstream and tissues at a rapid rate. This rapid out-gassing of nitrogen is called the bends (as it is felt in the joints—the bending joints of the limbs) and is painful and incapacitating.

A pilot or passenger who intends to fly after scuba diving should allow the body sufficient time to rid itself of excess nitrogen that was absorbed during the dive. If the appropriate amount of time is not allowed, decompression sickness due to gases released in the blood can result in a serious in-flight emergency.

As an absolute standard safety measure, any pilot flying near a large body of water should ask the passenger during the preflight if he or she has recently been scuba diving.

The following waiting times are recommended:

	Dives Not Req. Controlled Ascent	Dives Requiring Controlled Ascent
Flights up to 8,000 feet MSL	A minimum of 12 hrs.	A minimum of 24 hrs.
Flights above 8,000 feet MSL	A minimum of 24 hrs.	A minimum of 24 hrs.

### Spatial Disorientation

Spatial disorientation is not normally associated with slow and low (non-aerobatic) powered parachute flights. However, it is important to know that spatial disorientation is a condition of the body’s confusion relative to the spatial position. This commonly results from the eyes disagreeing with the sense of balance (the vestibular system of the inner ear) which may be disagreeing with the postural nerve impulses from the pressure areas in the skin and muscles. Hence, the brain gets conflicting spatial information. This condition is sometimes called vertigo.

The recommended procedure to deal with spatial disorientation is to maintain constant, straight and level flight via the throttle and remove all control input to the steering controls.

### Stress

Stress is a strong factor in pilot error. Stressful situations are very disruptive conditions. There are three categories of stress: environment (physical, such as loud noises), psychological (the loss of a loved one) and physiological (fatigue). Any of these factors can be influential on your mental capacities, and hence should be given consideration when beginning your medical self-evaluation prior to preflight inspection. Any pilot experiencing a high level of stress is not safe and should not fly as PIC.

### Stroke and Heart Attack

In the event you feel light-headed or dizzy, you should remove your feet from an input position on the steering controls. When you feel light-headed or dizzy, there is a possibility this could be a prelude to a heart attack or stroke. If you are about to experience a medical problem of this magnitude, then you could have a seizure or leg spasms (due to the pain from the heart attack) and therefore, uncontrollably and without intention, spiral yourself into the ground if the leg spasm induces severe steering input.

If you don’t feel “right”—pull your feet away from those steering controls, at least until you begin to feel better, and then get yourself safely on the ground as soon as possible.

### Medical Summary — “The Bottom Line”

Before even approaching the PPC, you must take a moment to reflect upon your current medical, physical, and psychological condition. It is in this reflective moment that you should begin to evaluate your ability to safely conduct the flight. Once satisfied with your self-evaluation, the preflight inspection can then continue. Using the “I’M SAFE” checklist is a smart way to start your preflight before getting to the powered parachute. Prior to flight, assess your fitness as well as the aircraft’s airworthiness. [Figure 1-5]



**Figure 1-5. Prior to flight you should assess your fitness, just as you evaluate the aircraft’s airworthiness.**



# CHAPTER 2

## AERODYNAMICS OF FLIGHT

Chapters 2 and 3 of the *Pilot's Handbook of Aeronautical Knowledge* (FAA-H-8083-25) apply to powered parachutes and are a prerequisite to reading this book. This chapter will focus on the aerodynamic fundamentals unique to powered parachute (PPC) operations.

### Aerodynamic Terms

**Airfoil** is the term used for surfaces on a powered parachute that produce lift, typically the wing itself. Although many different airfoil designs exist, all airfoils produce lift in a similar manner.

**Camber** refers to the curvature of a wing when looking at a cross section. A wing possesses **upper camber** on its top surface and **lower camber** on its bottom surface. **Leading edge** describes the forward edge of the airfoil. The rear edge of the airfoil is called the **trailing edge**. The **chord line** is an imaginary straight line drawn from the leading edge to the trailing edge. [Figure 2-1]

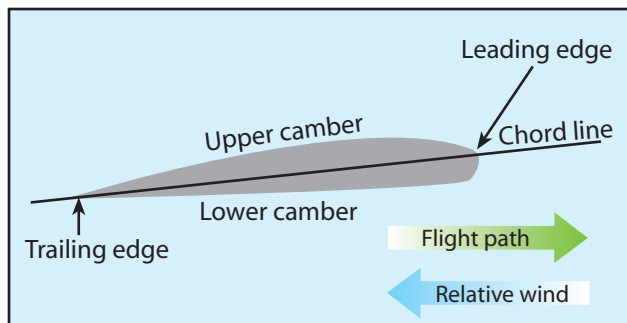

Figure 2-1. Aerodynamic terms of an airfoil.

**Relative wind** is the direction of the airflow with respect to the wing; it is usually parallel to and opposite the PPC **flight path**. Relative wind may be affected by movement of the PPC through the air, as well as by all forms of unstable, disturbed air such as wind shear, thermals, turbulence, and mountain rotors. When a PPC is flying through undisturbed air, the relative wind is parallel to and opposite the flight path.

**Angle of attack** is the angle between the relative wind and the wing chord line. [Figure 2-2]

**Longitudinal axis** is an imaginary line about which the aircraft rolls; it is also called the roll axis. The longitudinal axis is not a fixed line through the cart because the angle of incidence changes in turbulence and with loading changes.

**Angle of incidence** is the angle formed by the chord line of the wing and the longitudinal axis of the PPC cart. The cart longitudinal axis is not the same as the aerodynamic longitudinal axis defined in the previous paragraph. [Figure 2-2] Unlike an airplane, the angle of incidence can change in flight because of the flexible line attachment between the wing and the cart. Angle of incidence can change for different types of flight configurations and PPC designs; this is covered in detail in the “Moments” section.

**Trim angle** is the angle between the chord line of the wing and the horizontal plane when the PPC is in non-powered gliding flight. [Figure 2-3] The PPC wing is designed at a slight angle, with the chord line inclined downward to the horizontal plane to maintain the manufacturer-designed angle of attack during gliding, level and climbing flight. This “trim angle” is built into the powered parachute by the manufacturer and cannot be adjusted by the pilot moving the controls.

**Pitch angle** is the angle the PPC wing chord makes with the horizontal plane. Pitch angle is what you can see. Many pilots confuse the pitch angle, which you can easily see and feel, with the angle of attack which may not be as perceptible. [Figure 2-4] For example, the pitch angle in an engine-out glide could be minus 8 degrees, in level flight 10 degrees above the horizon, and in a climb it could be 28 degrees above the horizon. These are significantly different angles you easily see. Pitch angles are covered in greater detail in Chapter 6.

**Deck angle** is the angle of the cart’s lower frame (from the front wheel to the rear wheels), to the landing surface. The deck on the lower part of the conventional cart frame can be used to visualize deck angle. An imaginary line between the front and back wheel axles can also be used on unconventional carts.

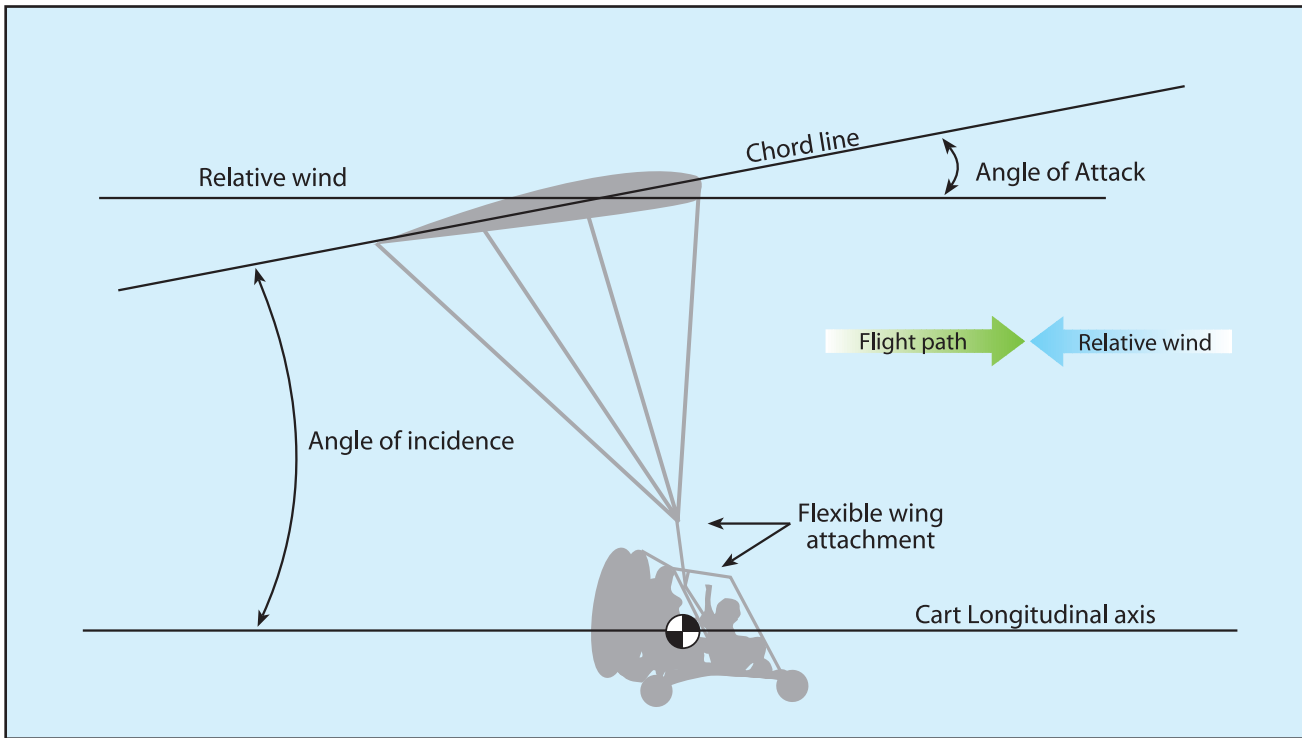

**Figure 2-2. Angle of incidence.**

**Planform** is the shape or form of a wing as viewed from above. The PPC wing comes in two wing planforms: rectangular, and elliptical. [Figure 2-5] The elliptical planform leading and trailing edges are curved to form an elliptical shape when viewed from the top or bottom. These two shapes have unique flying characteristics. Rectangular wings typically produce more drag, are lower-performance, and do not move fore and aft, relative to the cart, as quickly as elliptical wings. These characteristics are more obvious when the wing is inflating, during pitch changes, and when flying in turbulence. Rectangular wings are therefore more stable and require less effort to fly. Elliptical wings are higher-performance and more efficient due to less drag. Elliptical wings react more quickly with changing conditions and require greater pilot experience and skill during inflation, in turbulent air, and with abrupt throttle changes.

**Aspect ratio** is the wingspan divided by the average chord line. A PPC with a common 500-square foot rectangular wing (about a 38-foot wingspan) and with a typical mean chord line of 13 feet, would have an average aspect ratio of about 3. This relatively low aspect ratio is less efficient at producing lift. An elliptical wing with the same 500 square feet and a 45-foot wing span and an 11-foot average chord would have an aspect ratio of about 4. The PPC wing is similar to airplane wings in that the aspect ratio will differ with the specific design mission for the aircraft. Generally,

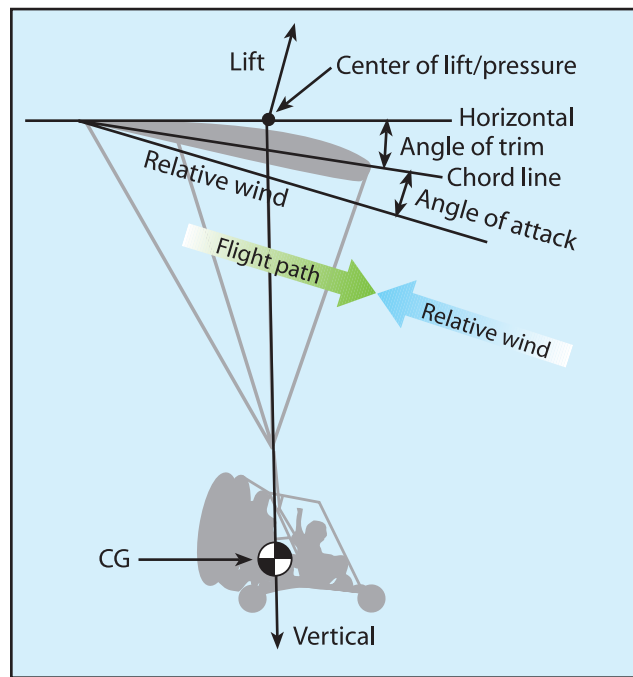

**Figure 2-3. Angle of trim and center of pressure in gliding flight.**

rectangular wings have lower aspect ratios and lower efficiency than the higher aspect ratio and higher efficiency elliptical wings. Generally, a high aspect ratio wing, compared to a low aspect ratio wing, produces higher lift at lower angles of attack with less induced drag. [Figure 2-6].



Figure 2-4. Gliding and climbing pitch angles.

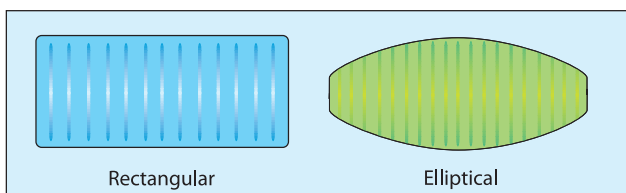

Figure 2-5. Planform view of a PPC inflated wing: rectangular and elliptical.

**Wing loading** is a term associated with the total weight the ram-air wing must support. Wing loading is found by dividing the total weight of the aircraft, in pounds, by the total area of the wing, in square feet. Wing loading is found by dividing the weight of the aircraft, in pounds, by the total area of the wing, in square feet. For example, the wing loading would be 2.0 pounds per square foot when 1,000 pounds—a common weight for a two-seat PPC with two people—is under a 500-square foot wing. If flying with one person the aircraft weight might be 700 pounds and the wing loading would decrease to 1.4 pounds per square foot.

**Gliding flight** is flying in a descent with the engine at idle or shut off.

### Powered Parachute Wing Pressurization and Flexibility

The powered parachute has two distinctive modes: (1) inflated, it is a ram-air wing with a curved arc—a recognizable airfoil shape; and (2) deflated, it is a canopy that is either lying flat on the ground or packed into a bag.

Note: Chapter 7, Takeoffs and Departure Climbs, will detail the methods of getting the uninflated canopy laying on the ground turned into a flying wing. Since the aerodynamics of the PPC do not start until the wing is completely inflated, this chapter will assume each reference to the PPC wing is to an inflated ram-air wing already in the shape of an airfoil.

The powered parachute ram-air wing retains its airfoil shape due to the air pressurizing the inside cells via the relative wind airflow being rammed into the front openings of the canopy—thus the term “ram-air wing.” The pressure inside the wing is much higher than the outside top and bottom because the dynamic pressure from the relative wind is converted to static pressure to pressurize the wing. The greater the speed, the greater the pressure inside the wing and the more rigid the wing. The cell openings are designed to be perpendicular to the relative wind to achieve maximum pressure from the relative wind. This static internal pressure harnessed from the relative wind is called dynamic pressure ( $q$ ), and is determined by the velocity squared times the air density factor. [Figure 2-7] Note the dynamic air pressure converted to static pressure at point A is constant throughout the wing points B and C. This static pressure is always greater than the pressure outside the wing at points X and Z.

Cross-port openings are placed in the ribs of each cell, connecting the adjoining cells. These cross-ports are dispersed throughout the wing (with exception to the outboard side of the end cells) to maintain positive pressure throughout. The pressure is constant inside

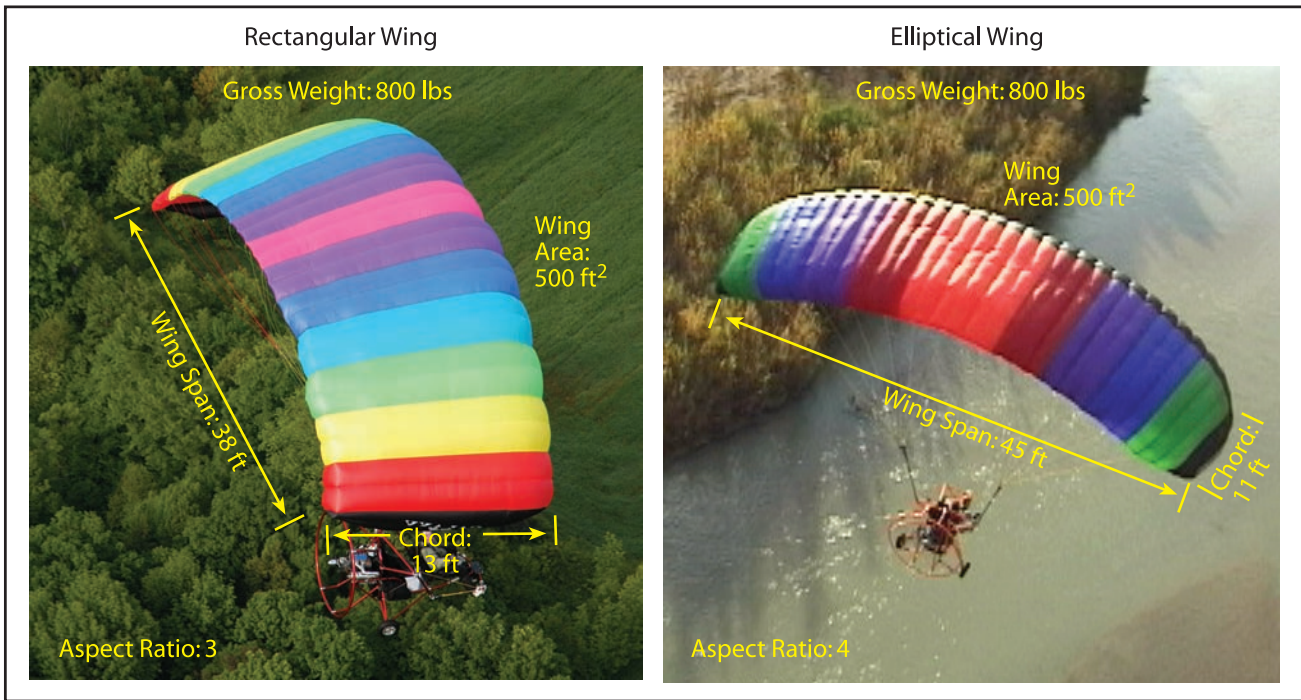

Figure 2-6. Aspect ratio comparisons for wings with similar areas.

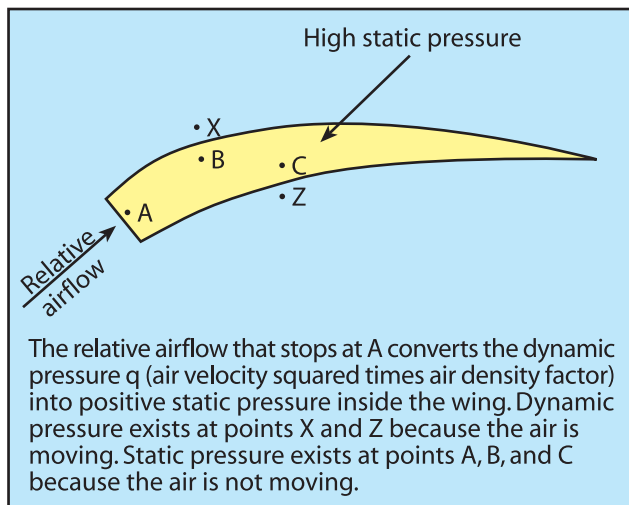

Figure 2-7. Dynamic pressure.

the wing because the dynamic pressure hitting the opening is the same for each cell and the speed is the same. The cross-ports aid the complete wing in becoming pressurized during inflation and maintaining the pressure throughout the wing in turbulence. [Figure 2-8]

The inflatable wing airfoil generally remains a consistent shape as designed by the manufacturer. However, pilot control of the wing to make a turn significantly changes the relative aerodynamic qualities of the PPC wing by pulling down the trailing edge similar to a flap on an airplane. [Figure 2-9]

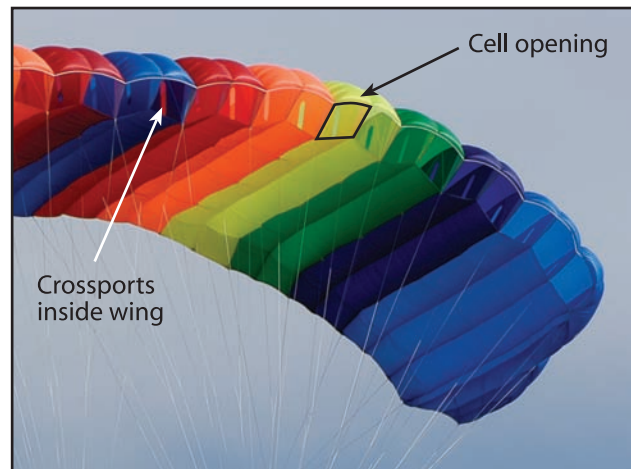

Figure 2-8. Cell openings and cross-port view.

Faster speeds from smaller wings or more weight create a higher pressure in the wing resulting in higher control forces because of the higher internal pressure.

## Forces in Flight

Like all aircraft, the four forces that affect PPC flight are thrust, drag, lift, and weight. [Figure 2-10] In steady PPC flight:

1. The sum of all upward forces equals the sum of all downward forces.
2. The sum of all forward forces equals the sum of all backward forces.

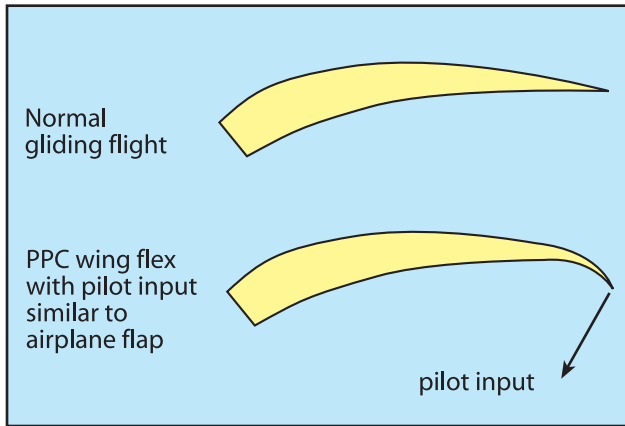

**Figure 2-9. PPC wing flexibility in flight.**

3. The sum of all moments equals zero.

**THRUST** – the forward force produced by a powerplant/propeller as it forces a mass of air to the rear (usually said to act parallel to the longitudinal axis).

**VS.**

**DRAG** – the aerodynamic force acting on the airfoil lines and cart in the same plane and in the same direction as the relative wind.

**LIFT** – the aerodynamic force caused by air flowing over the wing that is perpendicular to the relative wind.

**VS.**

**WEIGHT** – the force of gravity acting upon a body.

### Lift

Lift opposes the downward force of weight and is produced by the dynamic effects of the surrounding airstream acting on the wing. Lift acts perpendicular to the flight path through the wing's center of lift. There is a mathematical relationship between lift, angle of attack, airspeed, altitude, and the size of the wing. In the lift equation, these factors correspond to the terms coefficient of lift, velocity, air density, and wing surface area. The relationship is expressed in Figure 2-11.

This shows that for lift to increase, one or more of the factors on the other side of the equation must increase. Lift is proportional to the square of the velocity, or airspeed, therefore, doubling airspeed quadruples the amount of lift if everything else remains the same. Small changes in airspeed create larger changes in lift. Likewise, if other factors remain the same while the coefficient of lift increases, lift also will increase. The coefficient of lift goes up as the angle of attack is increased. As air density increases, lift increases. However, you will usually be more concerned with

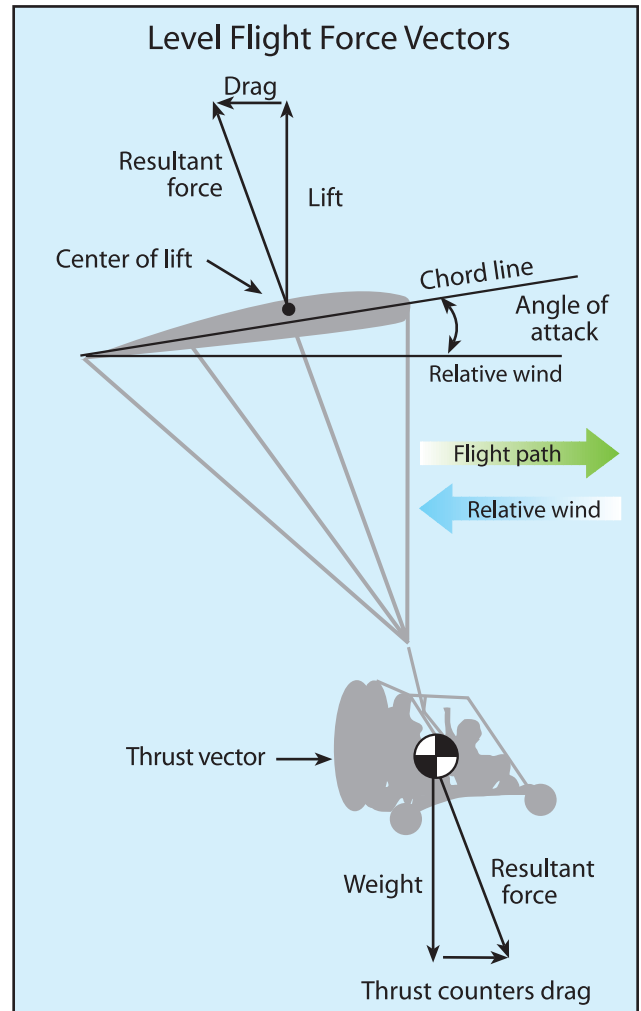

**Figure 2-10. Level flight forces.**

$$L = C_L V^2 \frac{\rho}{2} S$$

L = Lift

$C_L$  = Coefficient of lift

(This dimensionless number is the ratio of lift pressure to dynamic pressure and area. It is specific to a particular airfoil shape, and below the stall, it is proportional to angle of attack.)

V = Velocity (Feet per second)

$\rho$  = Air density (Slugs per cubic foot)

S = Wing surface area (Square feet)

**Figure 2-11. The lift equation.**



how lift is diminished by reductions in air density on a hot day, or if you are operating at higher altitudes.

All wings produce lift in two ways:

1. Airfoil shape creating a higher velocity over the top of the wing and a lower velocity over the bottom of the wing with Bernoulli's venturi effect.
2. Downward deflection of airflow because of the curvature of the wing with the principle of Newton's Third Law of Motion: For every action, there is an equal and opposite reaction.

Both principles determine the lifting force. Review Chapter 2 in the *Pilot's Handbook of Aeronautical Knowledge* to understand Newton's laws of motion and force and Bernoulli's principle of pressure.

## Drag

Drag is the resistance to forward motion through the air. Drag opposes thrust. Aerodynamic drag comes in two forms:

1. Induced drag: a result of the wing producing lift;
2. Parasite drag: resistance to the airflow from the cart, its occupants, suspension lines from the wing, interference drag from objects in the airstream, and skin friction drag of the wing.

Induced drag is the result of lift, and its amount varies as discussed above for lift. Induced drag creates organized circular vortices off the wing tips that generally track down and out from each wingtip. [Figure 2-12] This is true for all aircraft that use wings including PPC, weight-shift control and fixed wing aircraft. The bigger and heavier the aircraft, the greater and more powerful the wingtip vortices will be. This organized swirling turbulence is an important factor to understand for flight safety. Refer to Section 7-3 of the *Aeronautical Information Manual* (AIM) or Chapter 12 of the *Pilot's Handbook of Aeronautical Knowledge* (FAA-H-8083-25) for additional discussion.

Parasite drag is caused by the friction of air moving over the structure. Just as with lift, parasite drag increases as the surface area of the aircraft increases and dramatically increases as airspeed increases, at the square of the velocity. Therefore, doubling the airspeed will quadruple your parasite drag. [Figure 2-13]

The PPC has relatively slow speeds, but plenty of items (area) for the wind to strike including wing, lines, pilot, cart, engine, wheels, and tubes. Parasitic drag can be reduced by streamlining the items but since the PPC flies at relatively slow airspeeds, the

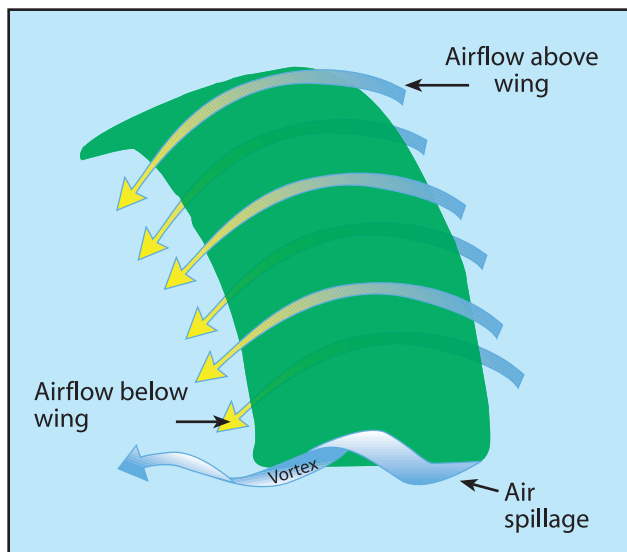

**Figure 2-12. Turbulence — induced drag wingtip vortices — created by lift of the ram-air wing.**

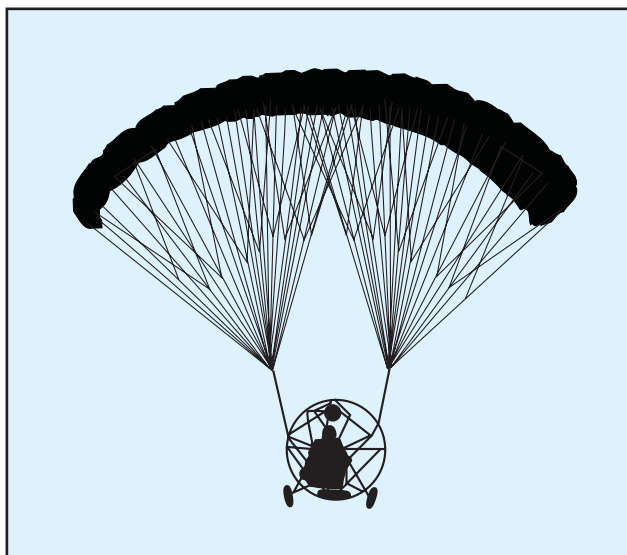

**Figure 2-13. Frontal areas of the cart, wing, and occupants are the source of parasitic drag.**

extra weight, cost, and complexity of streamlining the PPC is generally not incorporated into the design.

Total Drag is the combination of parasite and induced drag.  $Total\ Drag = Parasitic\ Drag + Induced\ Drag$

To help explain the force of drag, the mathematical equation  $D = C_d \cdot q \cdot S$  is used. In this equation drag (D) is the product of drag coefficient ( $C_d$ ), dynamic pressure (q) determined by the velocity squared times the air density factor, and surface area (S) of the cart and the ram-air wing (S). The drag coefficient is the ratio of drag pressure to dynamic pressure.

Induced and parasitic drag have opposite effects as angle of attack decreases and speed increases. Note the total drag. It is high at the slowest air speeds at high angles of attack near the stall, decreases to the lowest at the most efficient airspeed, and then progressively increases as the speed increases. The PPC wing is typically designed to fly at a speed generally above lowest overall total drag. Too slow, and the wing would be near its critical angle of attack. Too fast, and the power to maintain level flight or climb would be excessive. The manufacturer determines the speed range of the wing based on the weight range, and the resultant location on the total drag diagram. [Figure 2-14]

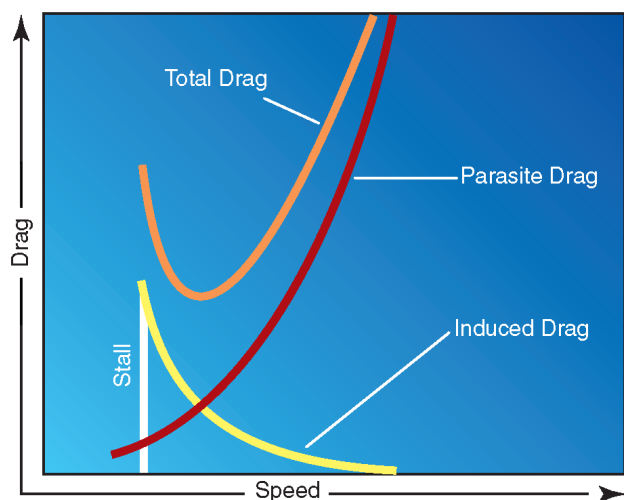

Figure 2-14. Relationship between drag and speed.

### Weight

Weight is a measure of the force of gravity acting upon the mass of the PPC. It is the force that opposes lift, and acts vertically downward through the aircraft's center of gravity. Weight consists of everything directly associated with the powered parachute in flight: the combined load of the total PPC (wing, risers, engine, cart, fuel, oil, etc.), people (clothing, helmets, etc.), and baggage (charts, books, checklists, pencils, handheld GPS, spare clothes, suitcase, etc.). In stabilized level flight, when the vertical component of lift is equal to the weight force, the PPC is in a state of equilibrium and neither gains nor loses altitude.

Because the trim angle is set at the factory, the PPC airspeed is predetermined, before takeoff, by the weight of the aircraft and the wing design. The more weight, the more forward airspeed is generated. Therefore, gravity is the primary force for creating forward speed — pulling the wing through the relative wind while airborne. The forces in gliding flight

are very similar to those for an airplane or gliding sailplane. [Figure 2-15] Specific numbers presented in this chapter are examples to serve as a basis to understand the concepts. Each PPC has unique flying characteristics and these numbers will be different, but can be compared to your PPC to provide a greater understanding of your unique performance. Note the component of weight acting along the flight path. This component of weight is called thrust by some but is more accurately the weight component providing the forward force.

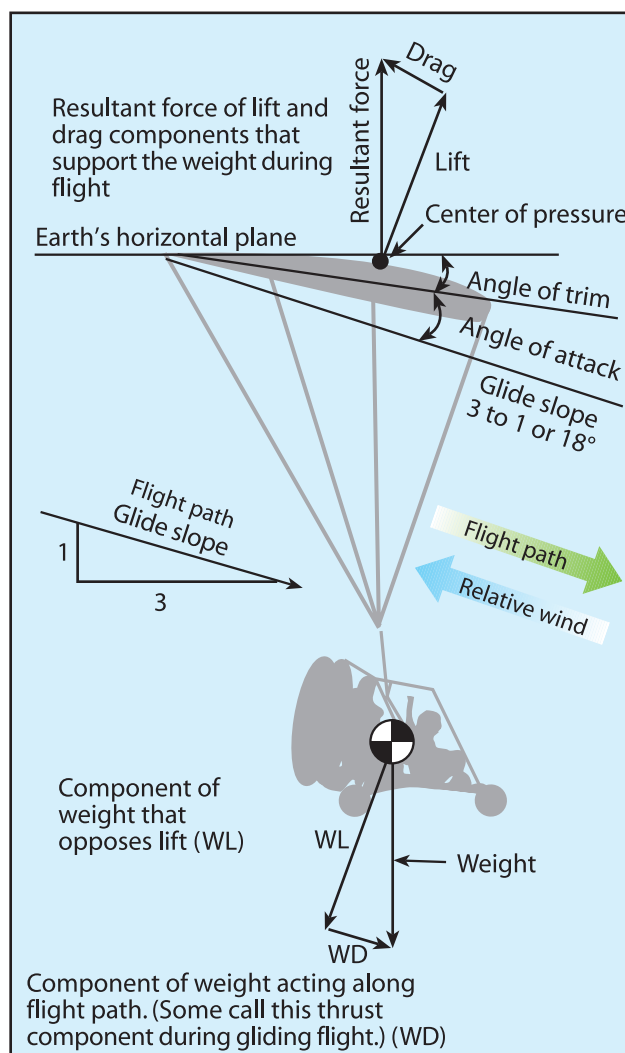

Figure 2-15. Typical forces in gliding flight, with no engine thrust.

### Thrust

Compared to an airplane, as discussed in Chapter 3 of the *Pilot's Handbook of Aeronautical Knowledge*, thrust serves different purposes in the PPC: (1) it is used to accelerate the PPC to flying speed while inflating the wing (2) it is used to climb when at high thrust, cruise level at medium thrust, and descend at lower thrust. Variations in thrust have negligible effect

on PPC airspeed which remains relatively constant whether climbing, descending, or in level flight.

When enough thrust is added to produce level flight, the relative wind stream becomes horizontal with the earth; the angle of attack and speed remain about the same. Just as described in the *Pilot's Handbook of Aeronautical Knowledge* for the airplane, thrust equals total drag for level flight. [Figure 2-16]

When in straight-and-level unaccelerated flight:

$$\text{LIFT (L)} = \text{WEIGHT (W)}$$

and

$$\text{THRUST} = \text{TOTAL DRAG (D}_T\text{)}$$

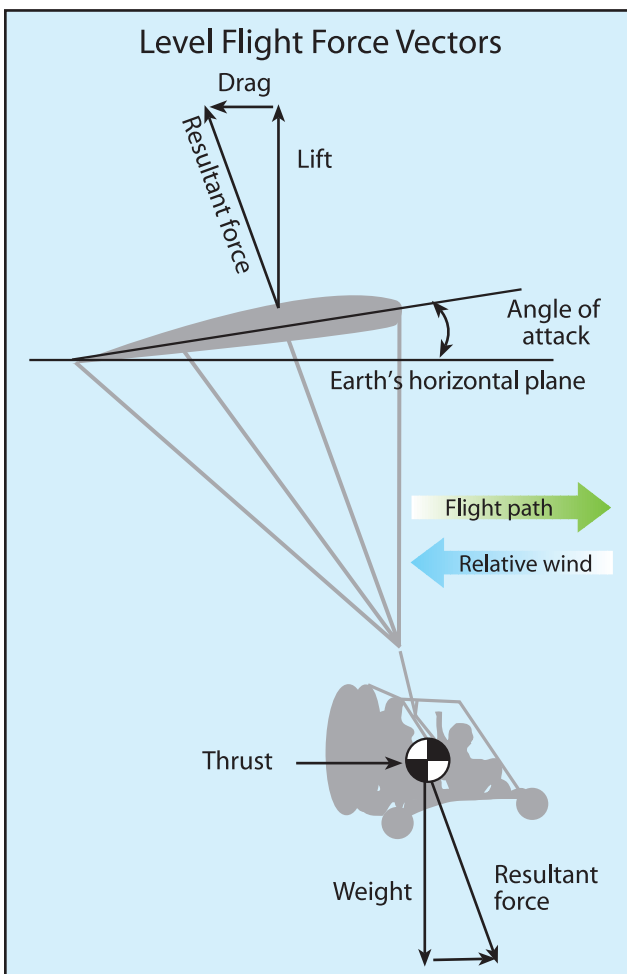

**Figure 2-16. Powered parachute in level flight.**

When excess thrust is added to produce climbing flight, the relative air stream becomes an inclined plane leading upward, while angle of attack and speed remain about the same. Just as described in the *Pilot's Handbook of Aeronautical Knowledge* for the airplane, the excess thrust determines the climb rate and climb angle of the flight path. [Figure 2-17]

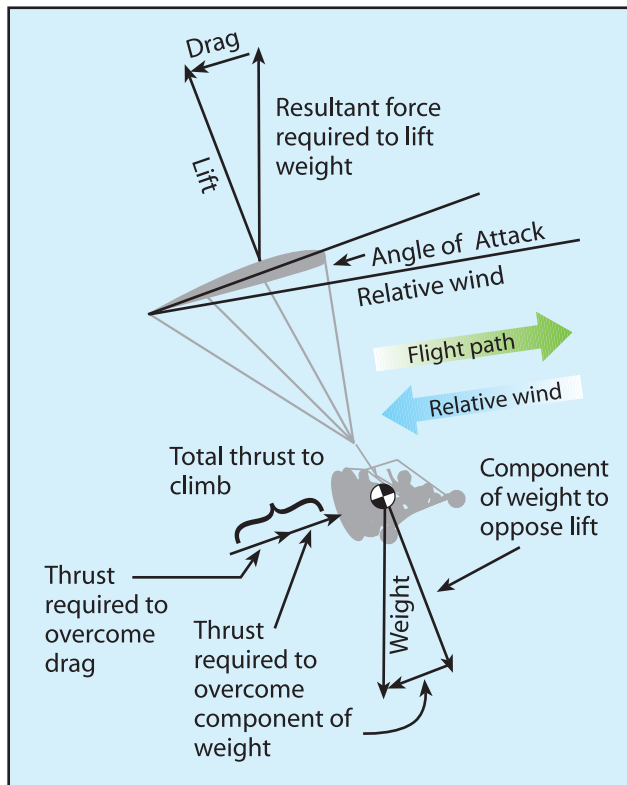

**Figure 2-17. Powered parachute in climbing flight.**

## Center of Gravity

The center of gravity (CG) is the theoretical point of concentrated weight of the aircraft. It is the point within the PPC about which all the moments trying to rotate it are balanced. The most obvious difference in the center of gravity for a PPC is the vertical position compared to an airplane, as it is much lower than the wing. The *Pilot's Handbook of Aeronautical Knowledge* accurately states the center of gravity is generally in the vertical center of the fuselage. The same is true for the PPC. However, the PPC wing is high above the fuselage (cart) creating the unique pendulum effect flying characteristics of the PPC (which will be covered in detail later).

In a two-seat PPC, the second seat is typically behind the pilot's seat, and the center of gravity is usually located directly over the rear passenger seat. Therefore, the center of gravity location does not change significantly with or without a passenger. Fuel tanks are typically located near the center of gravity so any differences in fuel quantity will not significantly change the center of gravity fore and aft with different fuel quantities.

## Axes of Rotation

Motion about the lateral axis or pitch is primarily controlled by the thrust of the propeller moving the PPC pitch up (nose up) to climb and pitch down (nose down) at reduced throttle.

Turning happens about the longitudinal axis and is the result of the rolling motion similar to an airplane with aileron and rudder control. To turn, pull down the wing trailing edge on the side you want to turn to with the steering controls. This creates drag on the corresponding trailing edge of the wing, thus dropping the inside wing, and rolling the PPC into a banked turn. [Figure 2-18]

There is not significant turning about the vertical axis because the PPC wing is designed to fly directly into the relative wind just like an airplane. Any sideways skidding or yaw is automatically corrected to fly straight with the wing design. An airplane uses the vertical tail to fly directly into the relative wind like a dart. The unique design of the PPC performs the same function through the combination of wing profile/taper, the arch or curvature from tip to tip, washout built into the wing and/or tip stabilizer design. These factors make the PPC track directly into the relative wind and eliminate the need for a vertical tail surface and rudder to make coordinated turns. Designs and methods vary with manufacturer and wing type, but all PPCs are designed to track directly into the relative wind.

## Ground Effect

Ground effect is the interference of the ground with the airflow and turbulence patterns created by the wing. The most apparent indication from ground effect is the unexpected lift given to an aircraft as it flies close to the ground — normally during takeoffs and landings.

Ground effect is usually felt when the wing is at altitudes of less than half of the wingspan. The typical PPC wingspan is approximately 38 feet with an average wing height of about 20 feet. Therefore, ground effect is negligible for PPCs and is typically not a factor.

## Moments

A body that rotates freely will turn about its center of gravity. In aerodynamic terms for a PPC, the mathematical value of a moment is the product of the force times the distance from the CG (moment arm) at which the force is applied.

Wings generally want to pitch nose down or roll forward and follow the curvature of the airfoil creating a negative pitching moment. This is one of the reasons airplanes have tails. The powered parachute does not need a tail because the airfoil is locked into a specific position relative to the cart by the suspension lines. [Figure 2-19]. Any pitching moment for the wing is counteracted by the strong pendulum effect (weight of the cart hanging directly under the center of lift). Any swinging of the weight creates moments that act to stabilize the swing. The wing aids to dampen swinging. This pendulum effect is unique to the PPC because the cart has the ability to rotate around the PPC pendulum axis of rotation in addition to rotating about the CG.

To understand the pendulum effect, attach a small weight (a pencil or paper clip works) to a 24-inch string. Note the weight always wants to hang directly under where you hold it. If you hold the string still and move the weight to the side, the weight swings and stabilizes under where you hold it. Gravity, pulling down on the weight to stabilize it directly under where it is hanging, is PPC pendulum stability. [Figure 2-20]

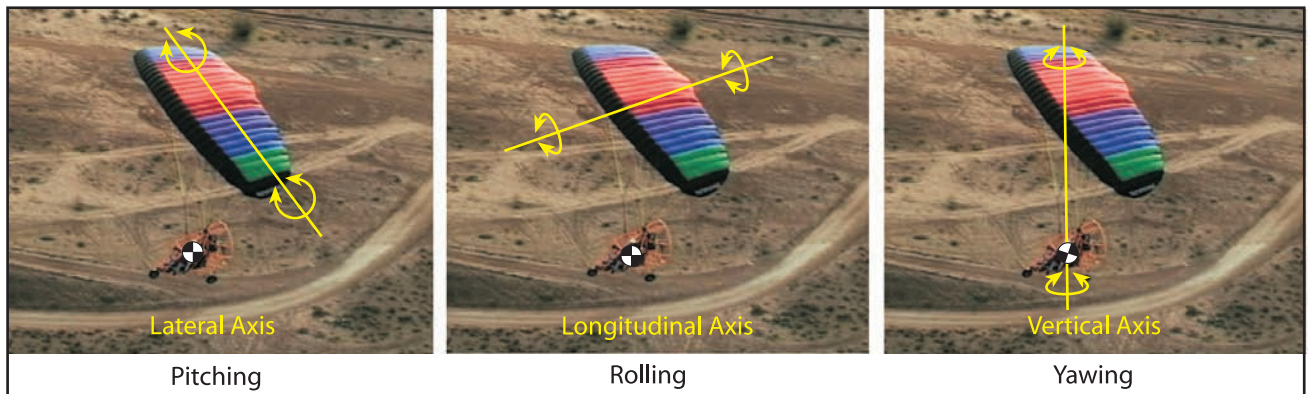
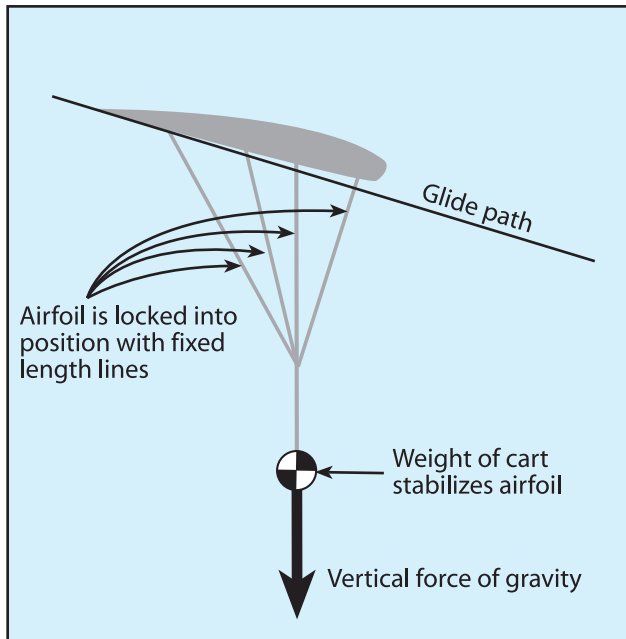

Figure 2-18. PPC axes of rotation.



**Figure 2-19. Powered parachute airfoil is locked into position by the lines and weight of the cart.**

Pendulum stability is the result of a number of PPC design characteristics: there is no downward force from a horizontal tail that must be counteracted by the wing producing more lift; there is no weight of the tail that must be lifted; and there is no tail to impose extra drag on the aircraft. Gravity is the primary force that stabilizes the aircraft using pendulum stability.

The “dynamic pendulum effect” can be demonstrated by swinging the weight around and then stopping the swinging to notice that the weight keeps swinging from the momentum. The swinging weight is known as the “dynamic pendulum effect” which will be discussed in detail later.

### Thrust Line Moments

PPC designs can have different moments caused by thrust; the propeller thrust may be above the CG (Figure 2-21 left) or go through the CG (Figure 2-21 right). Since the cart swings free in pitch, this CG thrust moment can slightly affect the pitch of the cart in relation to the wing.

PPCs with an attachment point above the thrust line have a pitching nose up moment as shown in Figure 2-21 (both diagrams), with a thrust line, wing attachment point, and arm “b.”

### Gravity Moment

There is a moment arm from the CG of the cart, to the cart/wing attachment (see “arms” in Figure 2-22). The longer the distance from the CG to the

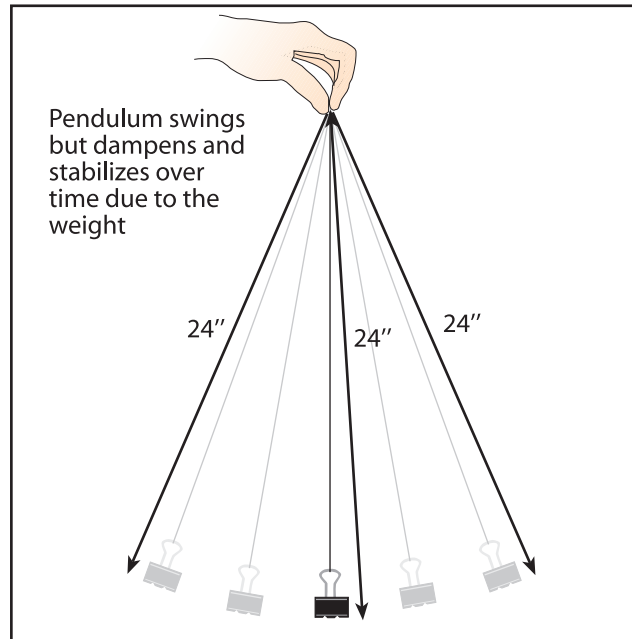

**Figure 2-20. Pendulum effect is like a weight on a string, stabilizing weight and line vertically over time.**

wing attachment point, the more stable the cart pitch is from thrust moments. The higher the wing attachment point above the CG, the more stable the cart is from swinging underneath and the less the cart will pitch up when thrust is applied.

A higher hang point will also better stabilize the PPC cart in turbulence because the moment of the weight and the larger “d” arm creates a larger stabilizing moment. [Figure 2-22]

For ground operations, the moment arm distance “c” cannot be too great or the front wheel would lift off the ground prematurely, trying to inflate the wing (see right side of Figure 2-22).

During flight, the advantage of a high attachment point arm “c” is less swinging around of the cart under the wing, and less cart “pitch up” when throttle is applied to climb. This high attachment point creates thrust that is now pointed slightly down to the relative wind, which has two significant effects. First, it creates a negative P-factor, counteracting increased torque. The second effect is a disadvantage: less climb rate or more thrust required for the same climb rate. This is due to the increased load on the wing from the thrust, requiring more speed and/or angle of attack to lift the total load. [Figure 2-23]

### Wing Attachment to Cart

If flying straight and level over a perfectly flat landing strip, then with the rear wheels 1 inch above the run-

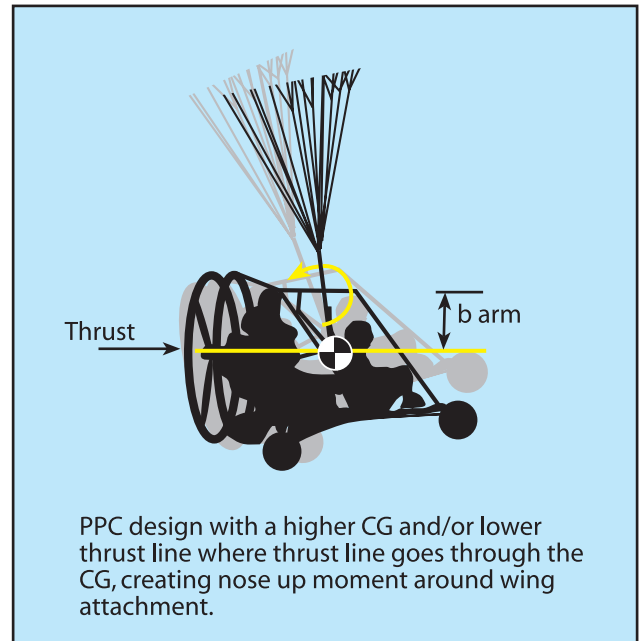
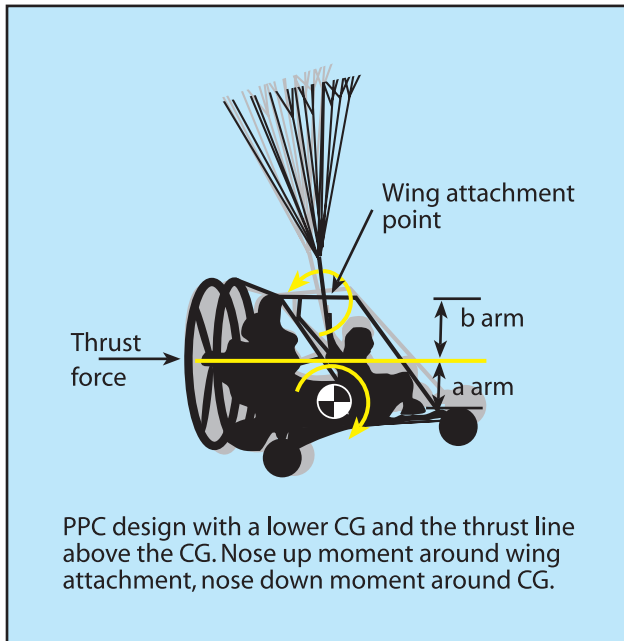

**Figure 2-21. PPC designs can have different moments caused by thrust; the propeller thrust may be above the CG (left) or go through the CG (right). A PPC can have wing attachment thrust moments as shown, or no wing attachment thrust moment if the thrust line goes through the wing attachment point (not shown).**

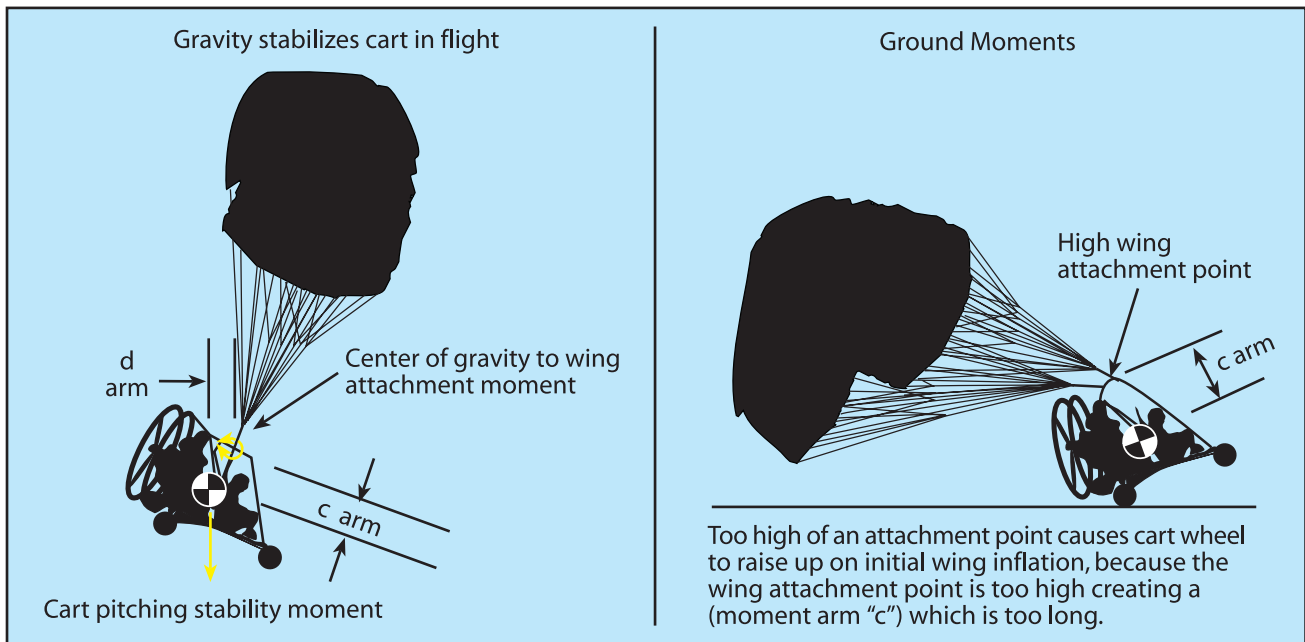

**Figure 2-22. Gravity stabilizes thrust moment.**

way, the nose wheel should be between 7 and 11 inches above the pavement. The POH specifies the wing fore and aft wing attachment points to the cart. [Figure 2-24] Attaching the wing too far forward would cause the nose wheel to be higher than it should. Attaching the wing too far back would place the nose wheel too low, where it would hit first for landings. Balancing the cart properly per the POH is important to make sure the cart is hanging properly under the

wing and ensure thrust is properly aligned as designed by the manufacturer. Nose wheel low means thrust pointing down, increasing loads, and airspeed. Nose wheel high has the opposite effect. Thrust aligned too high or too low results in reduced thrust and unwanted P-factor.

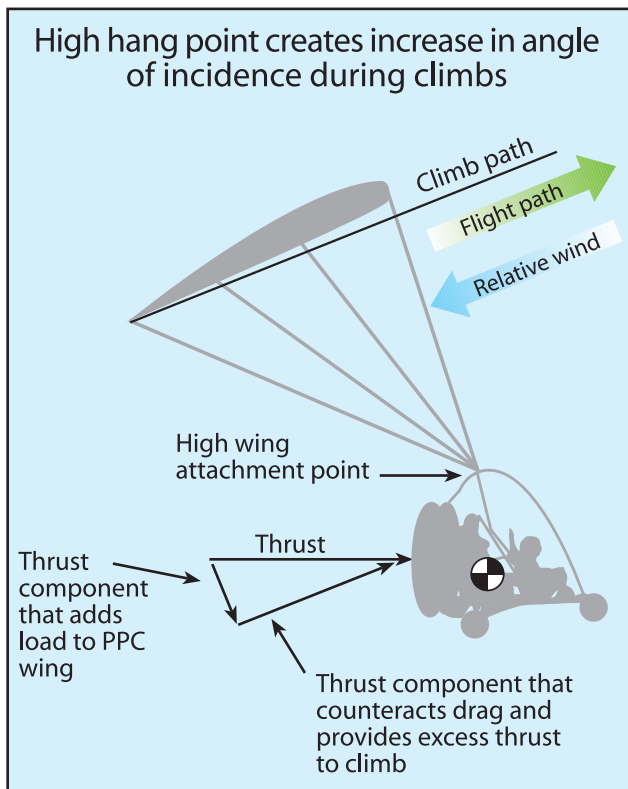

Figure 2-23. High wing attachment point effects in flight.

Manufacturers must balance the cart stability for take-off and flight, along with the thrust moment to achieve the best design for the specific application.

## Stability

A stable aircraft is one that will routinely return to its original attitude after it has been disturbed from this condition; usually this means returning to straight-and-level flight after encountering turbulence that disrupts a normal flightpath. The more stable the aircraft, the easier it is to return to a straight and level position. The natural tendency of the pendulum — the PPC cart hanging under the wing — is to return to its original centered position under the wing. The pendulum design gives the PPC airborne positive dynamic stability and positive static stability for roll and pitch because the weight of the pendulum wants to return the PPC to level stabilized flight. No matter what maneuver within the POH limitations the PPC is put through (regardless of whether it is pilot induced or turbulence created), as soon as the disruptive force stops, the aircraft is designed to return to a stabilized flight condition, with virtually no pilot input. Figure 2-25 shows the movements of the PPC as it auto-corrects from a side gust of wind.



Figure 2-24. Straight and level flight with the nose wheel 7 to 11 inches above the horizontal flight path.

## PPC Angle of Attack Characteristics

### Normal Flying Conditions

For all practical purposes, the wing's lift in a steady state normal climb is the same as it is in a steady level flight at the same airspeed. Though the flightpath has changed when the climb has been established, the angle of attack of the wing with respect to the inclined flightpath reverts to practically the same value, as does the lift. The angle of attack remains relatively constant for constant weights during stabilized flight for glide, level cruise or climb. However, wind gusts, flying in turbulence, quick uncoordinated flight (as covered later), or aerobatic maneuvers can change the PPC angle of attack. PPC limitations in the POH are specifically written to avoid any maneuver that would temporarily get the PPC into a situation of too high or too low an angle of attack. The PPC is specifically designed to fly at an angle of attack to avoid stalls (resulting from too high an angle of attack), and avoid wing collapses (resulting from too low an angle of attack). Each manufacturer specifically determines the limitations so a proper angle of attack is maintained throughout the flight operation range.

The basic design of the powered parachute is to fly at a relatively constant speed which results in a constant angle of attack. However, angle of attack can change just as with any aircraft as when a gust of wind

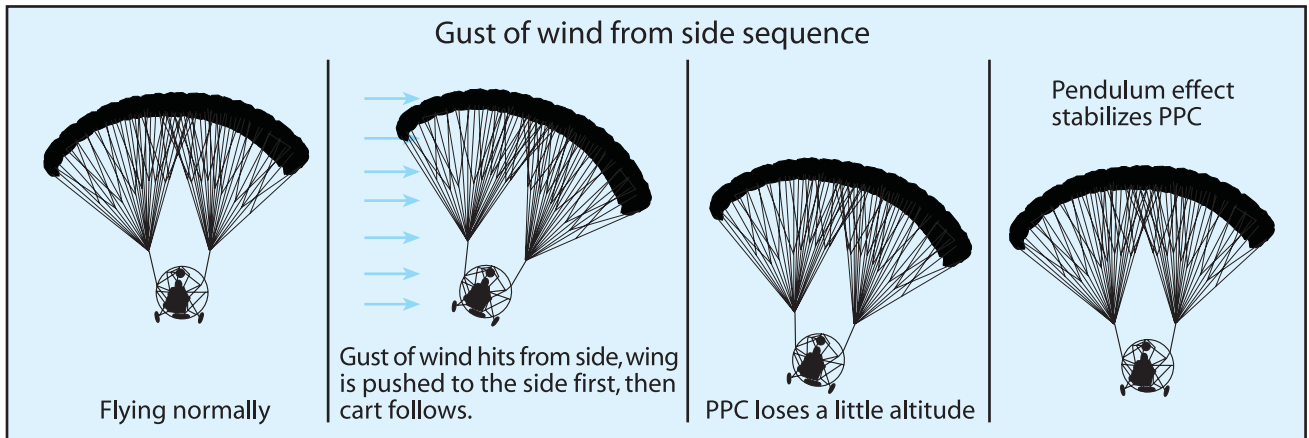

Figure 2-25. PPC stability after a side wind gust.

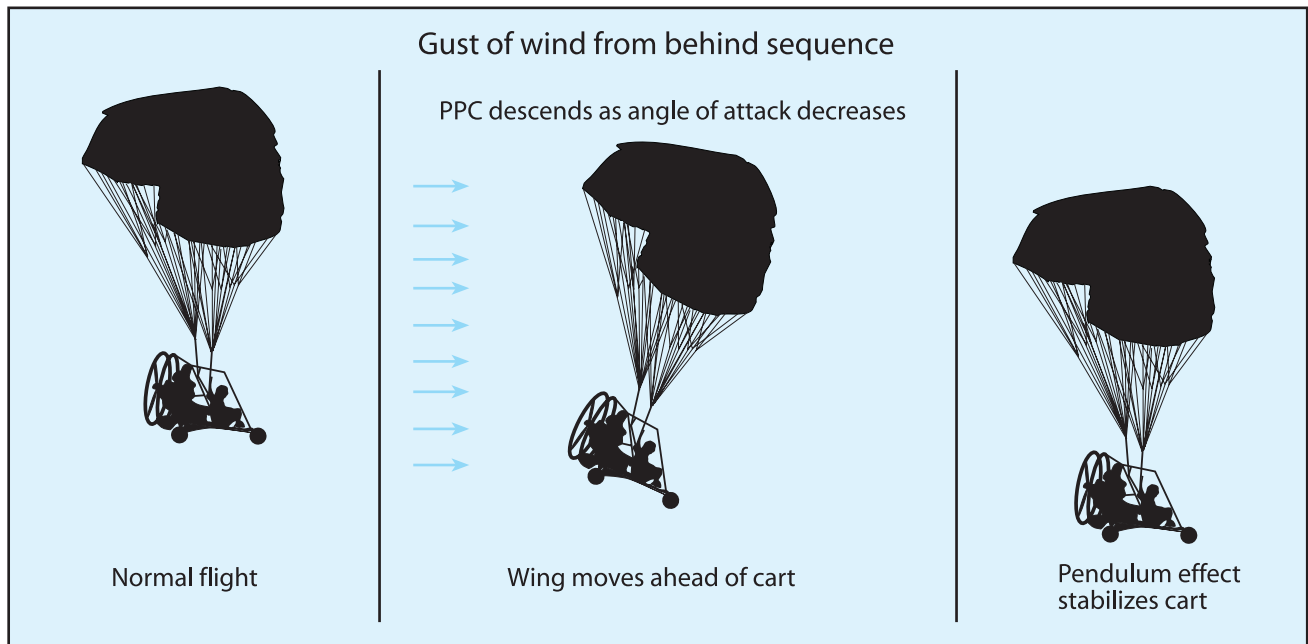

Figure 2-26. AOA changes as wind hits the airfoil.

changes the direction the air is hitting the airfoil. [Figure 2-26]

The pilot can add weight or increase loads which may also increase the angle of attack slightly.

### Flaring Increases Angle of Attack

The flare (pulling down the trailing edges of the wing—and thus lowering the trailing edge) increases the angle of attack. [Figure 2-27] In a flare, the trailing edges of the wing are pulled down (usually, as both foot steering controls are pushed forward). This is similar to lowering the flaps on an airplane: lift is increased, drag is increased, and for a PPC, the angle of attack is increased. The result is that the higher drag wing slows down and thus the wing moves backward relative to the cart. So as the total weight of the pen-

dulum (the cart and occupants) moves forward of the wing, the angle of attack increases, generating more lift and more drag. The pendulum is the weight of the CG under the wing which swings forward for this transient situation due to pendulum effect.

Note that flare provides a temporary large increase in the angle of attack (AOA) until the pendulum swings back underneath the wing. This action thus returns the wing to the normal stable flight configuration — the cart (the total weight of the pendulum) under the center of the wing. Therefore, a flare will only temporarily add an increase to lift and drag. Once the pendulum swings back down, the drag of the wing, and therefore the reduced airspeed, will continue until the flare is released.





**Figure 2-27. Flare on landing typically increases the angle of attack.**

### Porpoising Creates Variations in AOA

Another slight variation in the angle of attack is the swinging pendulum action of the PPC when high thrust engines provide strong and immediate full thrust of the propeller. This extra thrust swings the cart through the pendulum arc relative to its position under the wing. This is why many times you will see the PPC take off and porpoise until it stabilizes. This is a good example of the dynamic pendulum effect. As the propeller thrust swings the cart out front, the cart peaks then swings back to center. The cart successively swings back and forth, continuing to reduce oscillations until it stabilizes in a climb. This porpoising is most common with a high power engine. This can be eliminated by using gradual throttle increases so as not to create a dynamic pendulum effect entering a climb.

### Stalls: Exceeding the Critical Angle of Attack

The critical angle of attack is the angle of attack at which a wing stalls regardless of airspeed, flight attitude, or weight. The drawings in Figure 2-28 show airflow over a typical rectangular PPC wing. The first shows a laminar, smooth, lift-generating airflow—one that is typical when the angle of attack is within the flight range. The second depicts an exceeded angle of attack, turbulence and loss of the lifting force. [Figure 2-28]

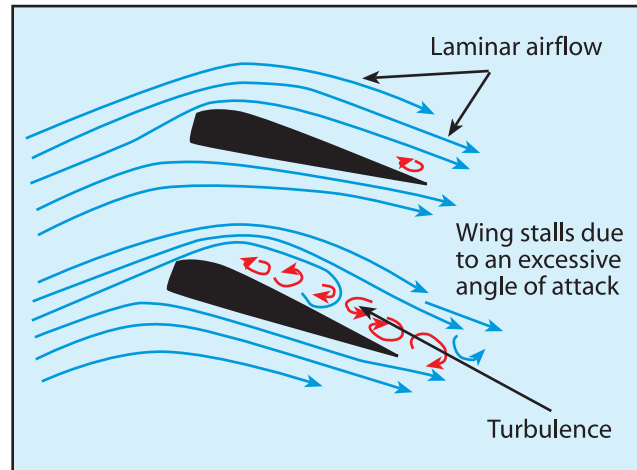

**Figure 2-28. Wings stall due to an excessive angle of attack.**

Unlike a fixed-wing aircraft that takes constant awareness of angle of attack to prevent a stall, the powered parachute wing is designed by the manufacturers to maintain a specified range of angle of attack and airspeeds. It is resistant to stalls because for all practical purposes, it is designed to fly at a constant normal operating range. This range is maintained if the operator flies within the operating limitations specified in the POH. Flying the PPC within the limitations specified in the POH and avoiding turbulence means you will not exceed the critical angle of attack and stall the wing.

However, situations that could contribute to a stall are:

- A large increase in wing drag (full-flare) — which the PPC pilot controls by pulling the wing back, thus increasing the AOA. (Note: A full-flare is normally used and recommended only for landings.)
- A quick full RPM throttle input, creating a climbing dynamic pendulum effect loading the wing.
- A quick reduction of throttle during a high pitch angle climb. This quickly turns a high pitch climb into a high angle of attack. The wing is initially pitched high, climbing the inclined plane under full power, then quickly changes to a gliding flight path when the throttle is reduced, just like an airplane.
- A wind gust from flying in turbulent air.

To prevent a stall, do not go to full-throttle while holding a full-flare, or as specified in the POH. Note: For explanation of a stall recovery, see Chapter 12: Night, Abnormal, and Emergency Procedures.

## Turning Effect

Torque is a reaction to the mass of the turning propeller. If the propeller is turning to the right, the reaction is for the cart to want to turn to the left. Therefore, a right turn is sometimes designed into the PPC system to counteract the torque.

PPC manufacturers compensate for this with various designs:

1. Dual (counter-spinning) propellers. This is an ideal way to counter prop torque, but counter-rotating gearboxes are complicated, more expensive, and weigh more.
2. Different riser lengths. On a clockwise-turning propeller, the left riser is longer than the right.
3. Swivel the wing attachment on a tilt bar above the cart.
4. Adjust the PPC frame (longer on the left, shorter on the right) to compensate for the engine torque (for a clockwise spinning prop).

Additionally, P-factor, as discussed in the *Pilot's Handbook of Aeronautical Knowledge* can be a factor, producing a left turn if the nose of the cart is too high

through improper CG balance of the PPC. Rotating propeller gyroscopic action can also produce turning tendencies if a force is applied which would deflect the propeller from its existing plane of rotation.

There is no corkscrew effect of the slipstream on a PPC because it does not have a tail in the propeller prop blast.

## Weight, Load and Speed Changes

Greater load factor creates increases in speed. For un-accelerated and stabilized flight there are only slight variations in speed for different flight conditions. [Figure 2-29] For an 800-pound PPC in gliding flight, both the lift and drag components support the weight of the PPC (lift is 759 pounds, and drag is 252 pounds, with the resultant 800 pounds vertical force).

In level flight, the PPC does not have the vertical component of total drag to support the weight so additional lift must be generated through speed or angle of attack increases.

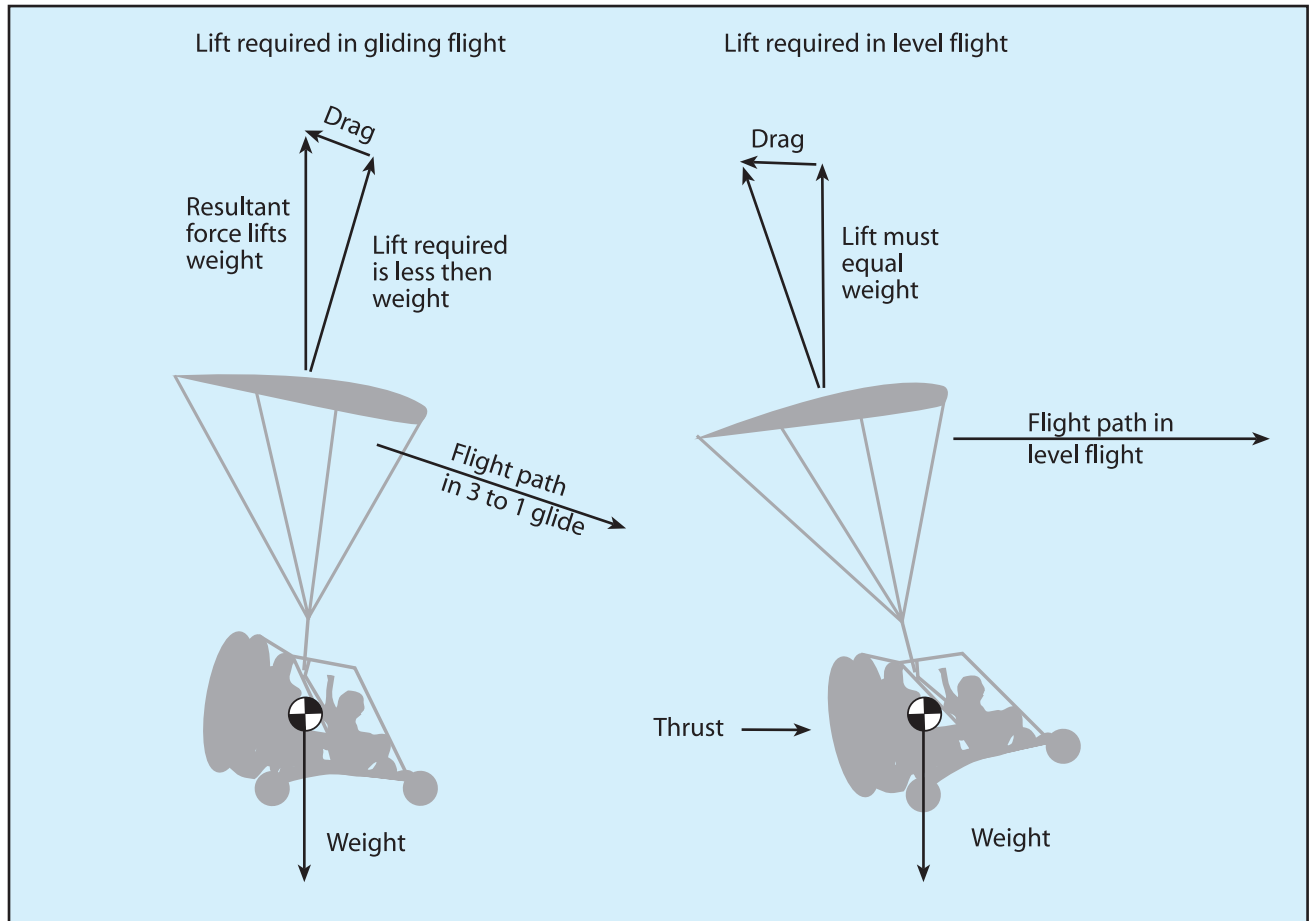

Figure 2-29. Forces differ between gliding and level flight.

The numbers are small and difficult to measure or feel so the industry rule of thumb is to assume the PPC flies at a constant speed and angle of attack with changes in throttle. However, increased load (weight) and load factor has a significant effect on speed. [Figure 2-30]

As discussed in Chapter 2 of the *Pilot's Handbook of Aeronautical Knowledge* the following points apply to powered parachute operations:

- During straight and level flight, the lift opposes the weight.
- In a banked turn, the lift is no longer directly opposite the weight; it is losing some of the vertical component of lift. More lift is needed so the vertical component of lift will equal the weight.
- In a banked turn, lift must be increased and load factor goes up. [Figure 2-30]

In a 45-degree turn, the 800 pounds weight would equal 800 times 1.4 or 1,120 pounds total load. This 45-degree turn, 1.4 G loading is the same as adding 320 pounds of weight to the 800 pounds. This new 1,120 pounds of lift must be produced by the wing by increased speed and/or angle of attack. If all the additional lift is produced from airspeed, airspeed would increase about 5 MPH, a noticeable difference. Refer-

ence your *Pilot's Operating Handbook* to understand the specific design considerations for the aircraft you will be flying.

## PPC Aerodynamics Summary

The following summarizes PPC aerodynamics:

- Increasing throttle causes the PPC to climb, decreasing the throttle allows the PPC to descend.
- The PPC flies at a relatively constant airspeed and angle of attack in normal flying conditions.
- The weight of the PPC controls steady state airspeed under similar conditions of wing size and type, trim, steering line settings, and pilot flare. Increased weight or load factor increases speed and/or angle of attack.
- The lighter the weight, the slower the airspeed, the less control pressure on the wing, and the slower your descent.
- The heavier the cart (total weight under the wing), the faster the airspeed, the more effort required for maneuvers (foot steering pressure), and the faster your descent.
- The wing set (rectangular or elliptical), size, and cart weight have a strong influence on PPC performance and maneuverability.

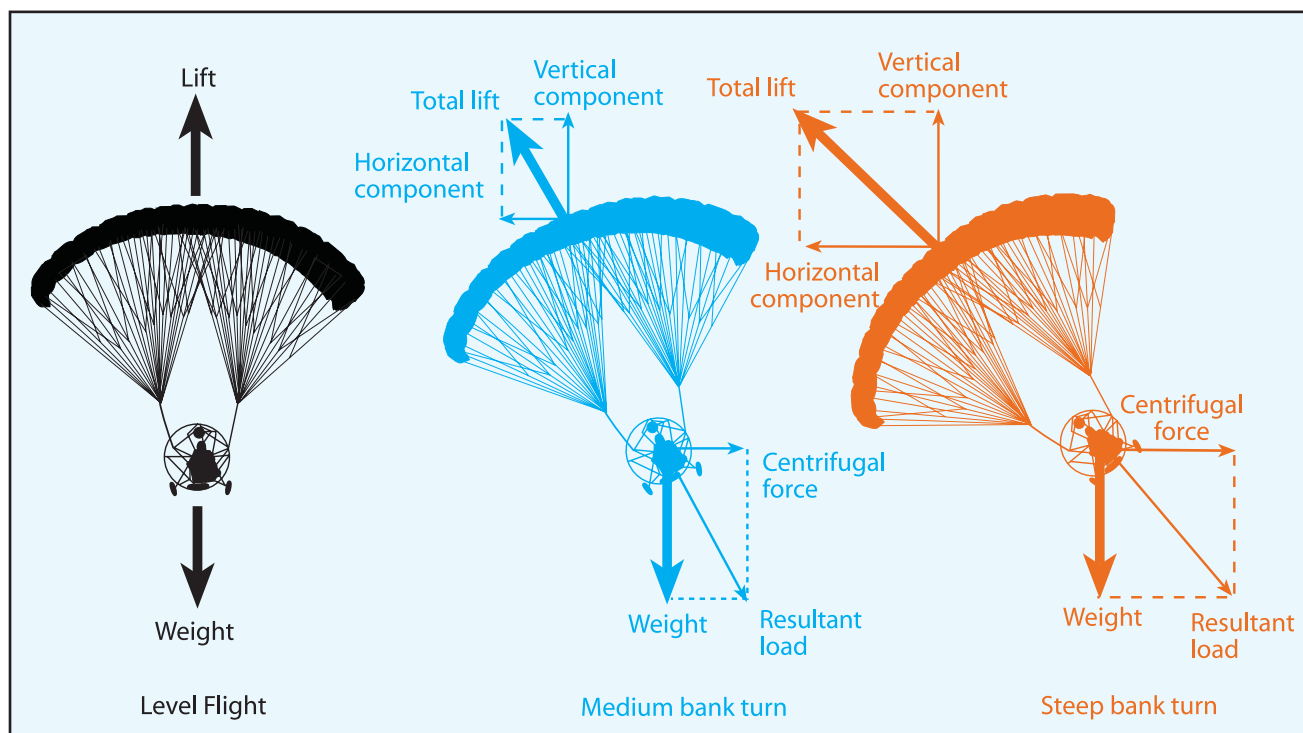

Figure 2-30. Loads and turning forces.

# CHAPTER 3

## COMPONENTS AND SYSTEMS

Although powered parachutes come in an array of shapes and sizes, the basic design features are fundamentally the same. All powered parachutes consist of an airframe (referred to as a cart) a propeller powered by an engine, and a ram-air inflated wing. [Figure 3-1]

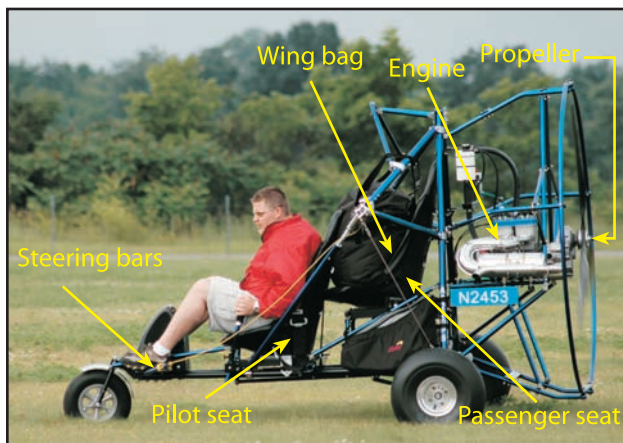

Figure 3-1. A typical powered parachute cart.

### The Airframe

Most powered parachute airframes are manufactured with aircraft-grade hardware. A few PPC manufacturers are building fiber-composite carts. The airframe's tubular construction means light weight and ease of replacement if tubes are bent. The airframe includes one or two seats, flight controls, and an instrument panel. The airframe also incorporates the engine, the fuel tank, the propeller and points of attachment for the wing and steering lines.

Although side-by-side configurations exist, in most powered parachutes the pilot and passenger are seated in a tandem (fore and aft) configuration. Dual flight controls are required for training. Not all PPCs have full dual controls; depending on the configuration of the cart and added controls (that are optional from different airframe manufacturers) the flight instructor can adequately control the aircraft during training from the rear seat during takeoff, flight, and landing procedures with dual throttle controls. While in the

rear seat, the flight instructor can have positive control of the aircraft at all times by physically pulling on the steering lines and using a dual control throttle. Like airplanes, not all powered parachutes are adequately configured to conduct flight training. The flight instructor with a powered parachute endorsement should determine his or her ability to control each individual PPC from the back seat with the dual controls for training purposes. [Figure 3-2]

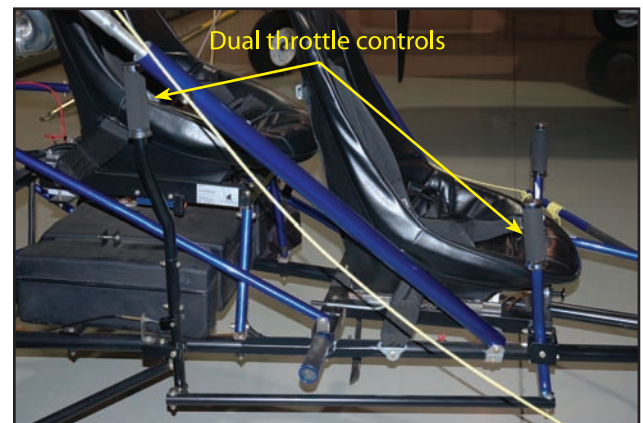

Figure 3-2. Powered parachutes used for training must be equipped with dual controls.

The pilot flies from the front seat in order to reach the steering bars, throttle control, ground steering control and magneto switches, and to keep the CG in balance; you cannot fly alone from the back seat for this reason.

The cart by itself is not very aerodynamic because it does not need to be; it flies at slower airspeeds. However, without the wing attached and inflated to limit speed, the pilot needs to be careful to avoid high speeds, such as when taxiing to and from the hangar for canopy layout. The wheels, their bearings, and the cart suspension were not designed to handle high speeds.

Some manufacturers use an adjustable front seat to allow for the varied length of the pilot's legs to comfortably reach the steering bars. Powered



**Figure 3-3. The harness should be fastened snug but not tight.**

parachutes can be outfitted with a variety of seatbelts, including a four-point harness system that securely fastens each occupant into their seat. [Figure 3-3]

Most powered parachutes have three wheels, or a tri-cycle gear configuration, although some have four. Ground steering is typically a steering bar connected to the nosewheel that moves left and right. Some powered parachutes have a tiller device for ground steering. There are a number of ground steering designs that vary between manufacturer, make, and model.

Brakes are an optional piece of equipment on the powered parachute, as the square foot area of the parachute itself provides aerodynamic braking. Pilots should use smooth and controlled operation of the throttle on the ground to maintain safe and controllable ground speeds, particularly when taxiing with the chute inflated. Students should practice throttle control to learn how far the PPC takes to come to a full stop when the power is reduced to idle. However, for runway incursion prevention and general safety, brakes are advised and highly recommended so you can stop when you need to. Never use your feet as a form of braking, as physical injury is probable.

## Center of Gravity Adjustments

Each manufacturer has specific procedures in the *Pilot's Operating Handbook* (POH) to adjust the CG of the cart, so that the cart is hanging at the proper nose high/nose low position—including the weight position in the cart and the fore/aft position of the wing attachment points.

As discussed in Chapter 2, the attachment points for the wing (parachute) must be adjusted for variations in pilot weight, which affect the center of gravity (CG) location of the cart.

There are typically two types of wing attachment systems: center of gravity adjustment tubes, or a bracket with a number of fore and aft attachment points. Each of these systems performs the same task. Either system adjusts the wing attachment points based on the cart CG. This is primarily based on the weight of the occupant in the front seat, usually the pilot. The rear seat occupant's weight does not typically come into consideration when determining the CG position of the PPC, as the rear seat is usually positioned very near the cart CG. To maintain the best overall performance, the aircraft needs to fly with a slight nose-up attitude, as specified in the aircraft POH.

Use the POH to determine the proper adjustment for the particular aircraft because there are many configu-



**Figure 3-4. Multiple attachment points for the wing as a means to adjust the wing hang point.**

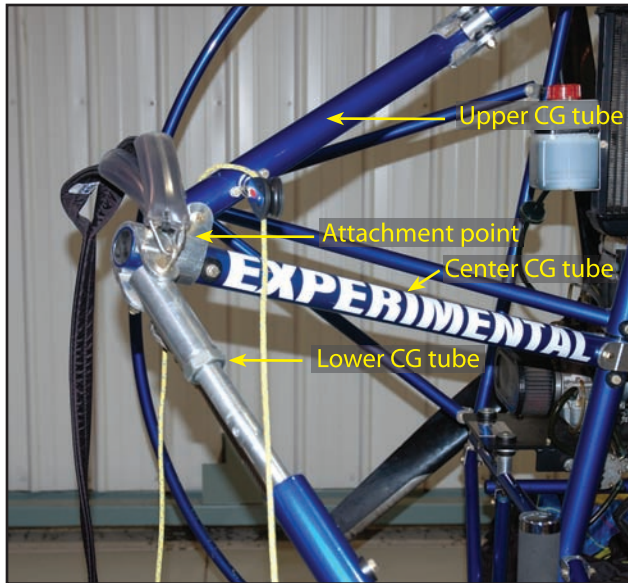

**Figure 3-5. PPC CG adjustment example.**

rations and designs that vary by manufacturer, make, and model.

### Multiple Attachment Points Bracket

The attachment point bracket on the cart is one method to select the fore and aft wing attachment position for proper CG adjustments. [Figure 3-4] Always refer to the POH for weight and balance information specific to the powered parachute you are flying.

### Center of Gravity Adjuster Tubes

The term “CG tubes” sometimes refers to the three tubes that meet at the point of rigging for the wing (upper CG tube, lower CG tube and center CG tube). [Figure 3-5] Sometimes the term “CG tube” refers only to the tube that is adjustable, and the other tubes that meet at the rigging points are called outrigger arms.

### Instrument Panel

The instrument panel is in front of the pilot and provides engine and flight information. The pilot is responsible for maintaining collision avoidance with a proper and continuous scan surrounding the powered parachute, as well as monitoring the information available from the instrument panel. The pilot must process the outside cues along with the instrumentation throughout the flight for a sound decision-making process.

The ignition switches are usually located on the instrument panel and have two positions: ON, which allows power to make contact with the spark plugs,



**Figure 3-6. Some instrument panels will have just a few digital or analog gauges for EGT and RPM.**

or OFF, which is a closed switch to GROUND and removes the power source from the spark plugs. Typically, PPC engines have two spark plugs per cylinder, two switches and two completely separate ignition systems. Some single place PPCs with smaller engines have only a single spark plug per cylinder, one ignition switch, and a single ignition system.

The FAA defines the required minimum instrumentation for PPCs; engine manufacturers may recommend certain instruments be installed on the aircraft to monitor the performance of their particular engine. For example, on a liquid-cooled engine, the manufacturer may recommend instrumentation to monitor engine gas temperatures (EGT), water temperatures and RPM. On an air-cooled engine, the manufacturer’s recommendation may be EGT, cylinder head temperature (CHT) and RPM. Additional instruments can be added as desired by the individual aircraft owner.

Some PPCs may only have a few analog gauges. [Figure 3-6] Some makes and models may be equipped with an engine information system (EIS). [Figure 3-7] The EIS is a flight computer and screen that receives input signals from sending units connected to engine and flight probes or sensors. The computers are pre-programmed for different makes and models of engines. Engine information may include: RPM, EGT, CHT, water temperature, fuel quantity, an hour meter and a voltmeter. Flight instruments may include altimeter, vertical speed indicator and a GPS.

This engine and flight information is viewed on the LCD screen and has function keys, allowing the pilot to move between display screens that contain the computer’s input. When the display button is pressed,



**Figure 3-7. Typical engine information system.**

each individual screen will clearly identify the information being displayed.

The information systems are also capable of alerting the pilot when any engine or flight parameters are exceeded, usually via a warning light mounted on the instrument panel. Although the EIS is a valuable tool, the ability to interpret the information is equally important.

For the interpretation of any engine and flight instrument, you need to completely understand the engine limitations, parameters, and the messages the instrument provides you. Sensing the proper operation of the aircraft and engine is a key factor to the safe operation of any aircraft. Being able to interpret engine sounds and unusual vibrations is essential for any pilot.

As with any aircraft or instrument operation, see the POH for each individual make and model operating instructions.

## Additional Equipment

A GPS can sometimes be used to determine ground speed while flying. A GPS is also a useful tool to enhance navigation for cross-country flying. Review Chapter 14 of the *Pilot's Handbook of Aeronautical Knowledge* for information on the calculations associated with determining wind speed, ground speed, fuel consumption, and time enroute.

Communication and navigation radios, transponders, GPS and LORAN receivers are not required to fly a powered parachute in Class G airspace. You must

have the required equipment on board to operate in Class B, C, D or E airspace.

Equipment requirements can be found in the regulations. Powered parachutes must meet these requirements. Even though many powered parachutes have strobe lighting to aid in the visual sighting of the aircraft, additional positional lighting is required for night operations. See Chapter 12 for more information.

## Electrical System

Powered parachutes are typically equipped with a 12 volt direct-current electrical system. A basic powered parachute electrical system consists of a magneto, alternator or generator, battery, master/battery switch, voltage regulator, and associated electrical wiring.

Electrical energy stored in a battery provides a source of electrical power for starting the engine and a limited supply of electrical power for use in the event the alternator or generator fails.

The electrical system is turned on or off with a master switch. Turning the master switch to the ON position provides electrical energy to all the electrical equipment circuits with the exception of the ignition system. Equipment that commonly uses the electrical system for its source of energy includes:

- Position lights.
- Anticollision lights.
- Instrument lights.
- Radio equipment.
- Electronic instrumentation.
- Electric fuel pump.
- Starting motor.

Fuses or circuit breakers are used in the electrical system to protect the circuits and equipment from electrical overload. Spare fuses of the proper amperage limit should be carried in the powered parachute to replace defective or blown fuses. Circuit breakers have the same function as a fuse but can be manually reset, rather than replaced, if an overload condition occurs in the electrical system. Placards at the fuse or circuit breaker panel identify the circuit by name and show the amperage limit.

An ammeter is used to monitor the performance of the electrical system. The ammeter shows if the alternator/generator is producing an adequate supply of electrical power. It also indicates whether or not the battery is receiving an electrical charge.

A voltage meter also provides electrical information as to the battery voltage, an additional status of your electrical system.

A voltage regulator changes the variable output of the magneto or generator to the 12-volt DC level for the battery and the electric system. The voltage output is typically higher than the battery voltage. For example, a 12-volt battery would be fed from the magneto/generator/alternator system through the voltage regulator which produces approximately 13 to 14 volts. This higher voltage keeps the battery charged.

## The Steering Bars

The steering bars are located just aft of the nosewheel and mounted on each side of the aircraft; they move forward and aft when the pilot applies foot pressure. [Figure 3-8] The steering lines from the trailing edge of the wing are attached to the outer ends of the steering bars. (Some manufacturers have developed a steering pedal system on their airframes, although the steering lines function in the same manner.) The main steering lines divide into various smaller lines, which attach to multiple points on the trailing edge of the wing. Pushing on either one of the steering bars causes the steering lines to pull down the corresponding surface of the trailing edge on the wing, creating drag. This in turn slows that side of the wing and banks the PPC into a turn.

Pushing both steering bars simultaneously causes the steering lines to pull down equally on the trailing edge, which causes two things to happen: it decreases the powered parachute's forward speed by increasing the drag and it changes the shape of the wing,

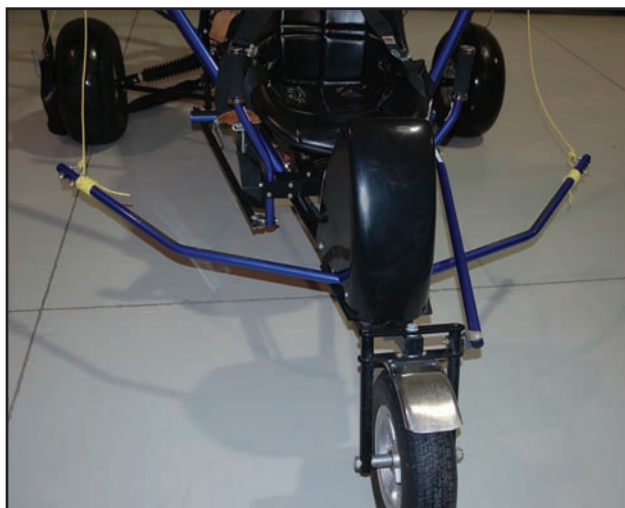

**Figure 3-8. Steering bars are located just aft of the nosewheel and mounted on each side of the aircraft.**

increasing angle of attack which increases lift. This procedure, called “flaring” or “braking the wing” allows the pilot to touch down at a slower rate of speed and descent, thus creating a smoother landing, which results in less wear and tear on the aircraft as a whole. [Figure 3-9]

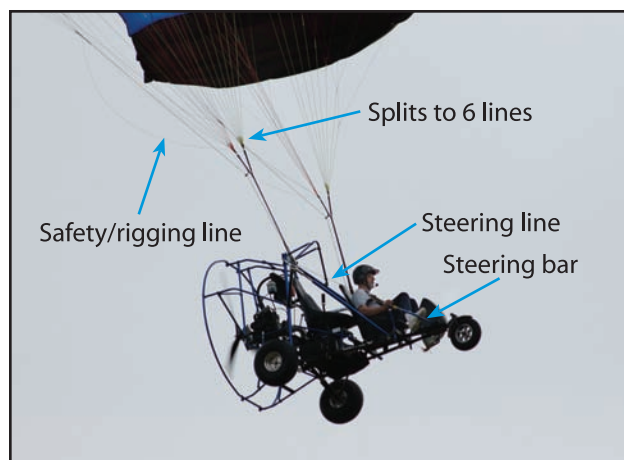

**Figure 3-9. Steering lines are divided into two sections; a single heavy line is attached to the steering bars.**

## Wings and Components

The powered parachute wing is unique, as compared to a fabric wing on an airplane, in that when it is not inflated it loses its ability to produce lift. When a powered parachute wing is inflated or pressurized, it becomes semi-rigid and is capable of producing lift and supporting a load. Rather than being bolted to the fuselage like an airplane, the parachute wing is attached to the cart by lines and cables which are known as risers.

The wings are manufactured by attaching an upper and lower section of skin to ribs. [Figure 3-10] The ribs of the wing determine the airfoil shape. [Figure 3-11] The shape of a powered parachute wing will change slightly when faced with different gross weights, air pressures, and environmental conditions such as moisture, air temperature and wind.

Different wing manufacturers use different fabric treatments to render the fabric airtight, so the air that enters the wing cannot escape through the fabric surface. The top surface of the wing is generally treated to help protect it from ultraviolet light and the elements. Keeping the powered parachute wing out of direct sunlight will increase its useful life.

If the fabric degrades and air is allowed to escape through pores of the cloth, the overall flight performance of the wing is greatly reduced. If your pow-



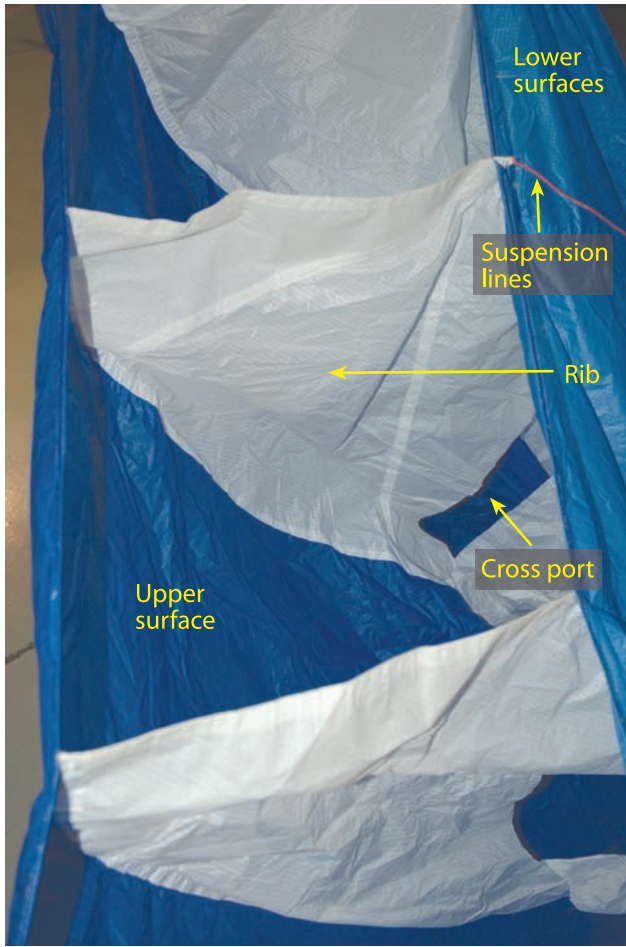

**Figure 3-10. Canopy cross-section.**

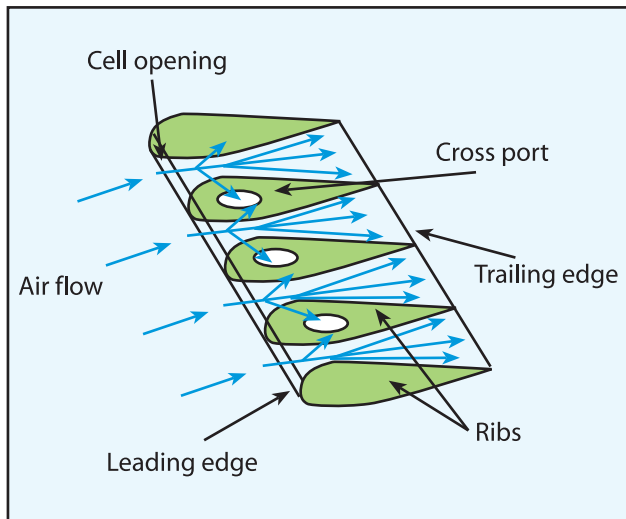

**Figure 3-11. Airflow into the wing.**

ered parachute wing should become too porous, more groundspeed may be needed to pressurize the wing, takeoff distance may increase, more RPM may be required to hold altitude, and fuel consumption may increase.

At first sight, the suspension lines on the powered parachute wing might appear like an unorganized wad of strings. On the contrary, each line has a distinct purpose and each line has distinct properties. The suspension lines are sometimes designated A through D and differ between manufacturers; check your POH to know the line labels for your PPC. [Figure 3-12] The front suspension lines are located at the leading edge and the steering lines connect to the trailing edge. The

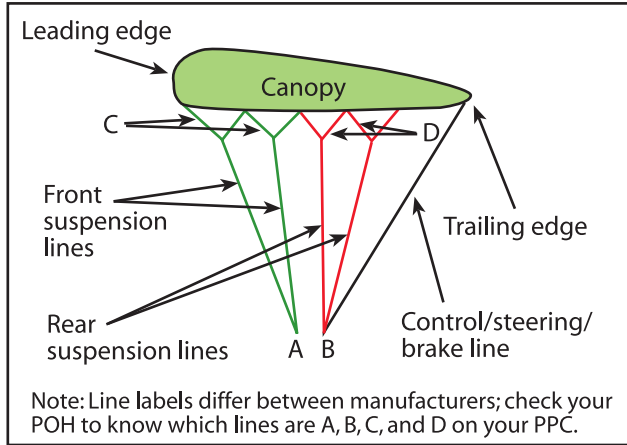

**Figure 3-12. Front and rear suspension lines.**

suspension lines come together at a point where they connect with the riser. (The risers are the connection between the suspension lines and the cart.) Many manufacturers color-code the wing suspension lines to assist the pilot in their preflight inspection and layout of the wing prior to inflation. [Figure 3-12]

Suspension lines must be constructed of very strong materials, yet remain very small in profile to reduce parasite drag. The most commonly used materials are polyaramid and polyethelene, which are both carbon based.

Kevlar® is a common polyaramid used for suspension lines. Its properties render it extremely strong, as well as resistant to stretching or shrinking, and it is not susceptible to temperature changes. However, one critical drawback of polyaramids is that they tend to kink or knot when looped around. When polyaramids are used to construct suspension lines, they are encased in a skin of a terylene product, like Dacron® or a product with similar properties. Polyethelene materials, such as Spectra®, Dyneema® or Technora®, are very strong as well as more flexible than polyaramids, which makes them more durable under hard use. However, polyethelene materials are more likely to stretch or shrink, and they are more susceptible to temperature changes. If your wing is equipped with polyethelene suspension lines, it is imperative you do not store your

equipment in a place that might experience extreme temperatures. The POH or owner manual provided by the chute manufacturer will specify limits for temperature and storage.

Every line on the powered parachute wing is precisely measured and fitted to a specific location. Therefore, it is imperative to inspect the wing during preflight, in addition to having the wing and its lines inspected periodically by qualified technicians. The technician will conduct strength tests as well as look for wear and compromised attachment points; refer to your wing manufacturer's specifications for inspection parameters. Under no circumstances should powered parachute suspension lines be spliced or tied if severed! Each line's length and strength is specifically calibrated. If you tie a knot in the line you will change the specifically-engineered flight characteristics of the wing, rendering it unairworthy.

## Risers

Also known as "V lines," the risers are the intermediate link between the suspension lines and the airframe or the attachment point of the wing to the airframe.

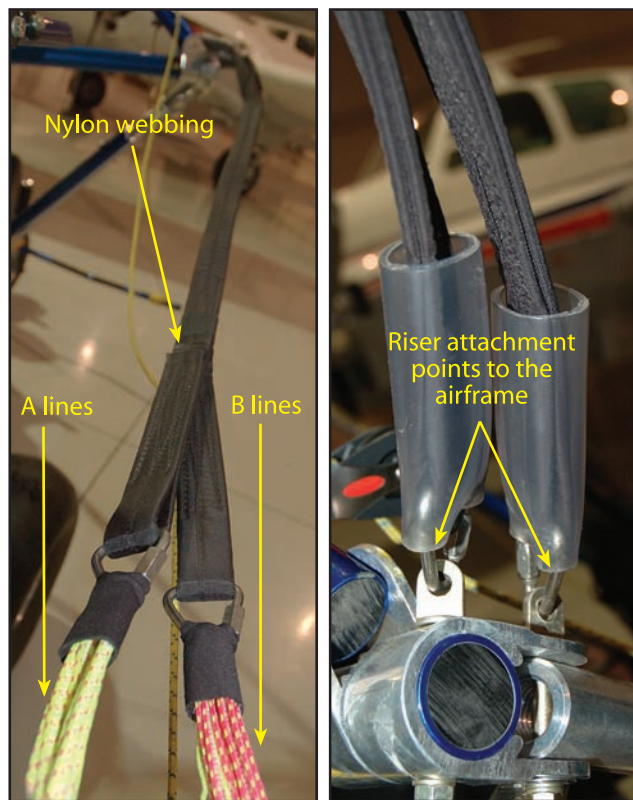

**Figure 3-13. The risers are constructed of nylon webbing that takes on the appearance of two straps incorporating a main cable and a safety cable as one unit.**

The risers are generally constructed of webbing, which takes on the appearance of two straps that incorporate a main cable and a safety cable as one unit. [Figure 3-13] Some of the older designs of wings may have braided wire cables serving as their risers. The risers are connected to the suspension lines and to the aircraft with various connections such as with D-rings and eyebolts.

During flight, as discussed in Chapter 2, propeller-driven aircraft are affected by the rotation of engine components and the propeller. This is commonly referred to as the "left turning tendency," which includes torque and sometimes P factor. There are several design features that have been incorporated into airplanes to counteract the left turning tendency from a clockwise turning propeller. Powered parachute designers can counteract the turning effect by changing the length of the riser cables on one side of the airframe. By decreasing the length of the right riser cable, the wing is given a slight right turn, just enough to cancel the effects of torque at cruise thrust settings. This design feature of the powered parachute wing risers makes it imperative not to mistakenly attach the different length riser cables on the wrong side of the airframe. Remember: the left main and the left safety cables, from the pilot's seat, are longer than the right main and the right safety cables. Mixing the right and the left cables will result in a pronounced left turn; especially during takeoff when the engine is at full throttle, which could jeopardize the safety of all concerned.

Engine installations with a counterclockwise rotating propeller require opposite adjustments. It is important to know which direction the propeller turns for your PPC to accurately counter turning tendencies.

Alternately, the wing could have the same length risers, and the cart could have a higher attachment point for the left riser. This is why each wing is designed for each cart and should not be interchanged: the wing and the cart is a complete system.

## The Fuel Tank

The powered parachute is usually equipped with fuel tanks ranging in capacity from 5 to 20 gallons. As with any aircraft, knowing how much fuel your fuel tank holds is crucial to flight operations. The light-sport aircraft powered parachute has no limitations as to the size of the fuel tank, unlike its ultralight vehicle predecessor. Most PPC powerplants require auto fuel mid-grade or higher to be burned (see the powerplant

operating handbook for specific engine specifications).

Generally, the fuel tank is located close to the center of gravity, so fuel burn does not affect the balance of the aircraft. Some fuel tanks are clear for visual inspection of the amount of fuel on board while others are dark. Dark tanks or hidden tanks generally have a sight tube to assist the pilot in determining the actual amount of fuel. [Figure 3-14] Some powered parachute manufacturers offer optional fuel level probes and instrument panel analog gauges or incorporate this information into the EIS. As fuel is used by the engine, air needs to enter the tank and take its place; otherwise a vacuum will form inside the fuel tank preventing the fuel pump from drawing fuel. This is usually accomplished with a fuel venting system. This can be a vent in the fuel cap or some other means that vents elsewhere, providing the ability for the fuel tank to breathe. Any vent system must be free of debris or it will cause fuel starvation in flight. This is especially true when a small hole is in the fuel cap that can be easily plugged. Check the fuel venting system during each preflight inspection.

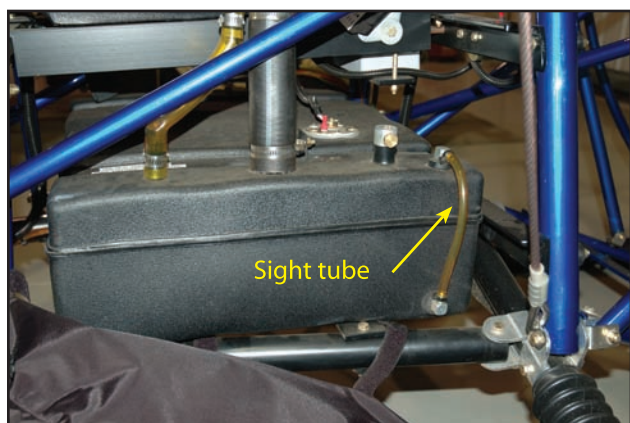
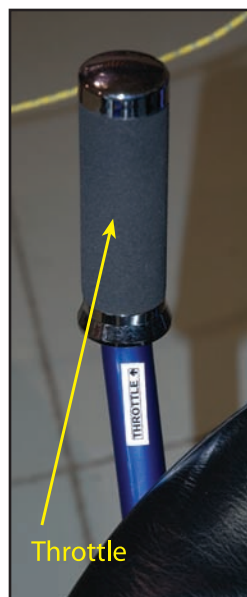

**Figure 3-14. Fuel tank with sight tube.**

The fuel shut-off valve can be located anywhere in the fuel line. It is important to make sure the fuel valve is open and stays open for normal operation. Most designs have a fuel tank sump drain valve to remove water and solid contaminants. Each design is different and the PPC POH will specify how to conduct this check.

## Throttle System

The throttle is the pilot's hand control to regulate the power provided by the engine. The configuration of the throttle control varies from one cart manufacturer to another. Refer to the POH of each individual PPC for function reference. [Figure 3-15]



**Figure 3-15. Powered parachute throttle.**

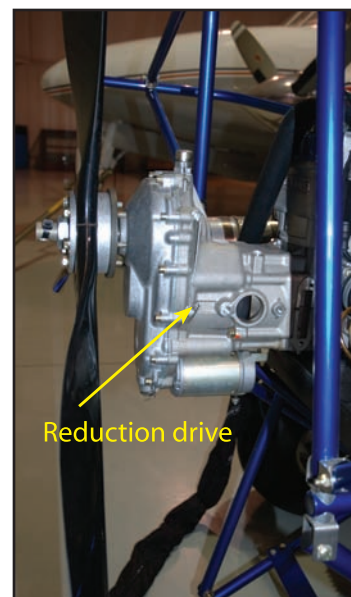

**Figure 3-16. Reduction drives reduce the propeller RPM from the engine RPM by about half.**

## The Powerplant

The typical powered parachute engine can be two- or four-stroke, liquid- or air-cooled, 50 to 100 horsepower. Some engines have electric starters and some have pull starters. Most PPC engines have reduction drives that, when attached, reduce the propeller RPM to half to one quarter the engine RPM. [Figure 3-16] The engines are as varied as the powered parachutes they power. Modern technology has allowed the powered parachute engine to become lighter, more efficient and, most importantly, dependable. Chapter 4 covers the powerplant in more detail.

## The Propeller

Propellers are “power converters” that change the engine horsepower into “thrust.” Thrust is the force that propels the aircraft through the air by pushing the powered parachute forward. Aerodynamically speaking, a propeller is a rotating airfoil and the same principles that apply to the wing will apply to the propeller. [Figure 3-17] Engine power is transferred to the propeller through a rotating crankshaft that turns the propeller through the air, producing thrust in the same way as wings produce lift. The shape of the blade creates thrust vectors because it is cambered like the airfoil of a wing. Consequently, as the air flows past the propeller, the pressure on one side is less than that on the other. As in a wing, this produces a reaction force in the direction of the lower pressure. In the case of the propeller, which is mounted in a vertical plane, the

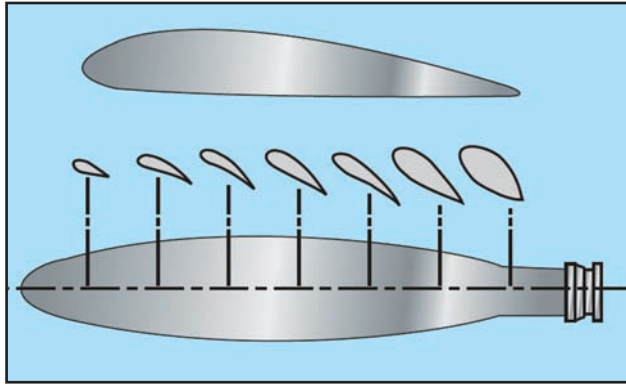

**Figure 3-17. Airfoil sections of a propeller blade.**

area of decreased pressure is in front of the propeller, and the force (thrust) is in a forward direction. Aerodynamically, the thrust is the result of the propeller shape and the angle of attack of the blade.

The typical powered parachute has a ground adjustable propeller. The adjustment of the propeller should only be conducted to meet the engine manufacturer's maximum recommended RPM target. Pilots who are not familiar with adjusting the propeller and how it will affect the PPC performance should consult with a knowledgeable source prior to making any propeller adjustments.

The engine mount is designed by individual manufacturers for each cart configuration. The majority of the total aircraft weight is determined by the engine and mounting configuration. When trailering the PPC over bumpy terrain or over long trips, the bouncing of the cart in the trailer can put extreme stress on this mounting system. In addition, repeated hard landings of the cart can also stress the welds of the engine mount. Consistent detailed inspections of the engine mount should be an important part of every preflight and post-flight inspection.

Just like an airplane propeller, the powered parachute propeller turns at such great speeds that it becomes invisible when in motion. The dangers of a turning propeller require every pilot to maintain the highest level of safety and respect for the consequences of body parts, pets, and debris coming in contact with a rotating propeller. Always treat the propeller as if the ignition were on. Debris on the takeoff/landing field is a danger to the propeller as well as to the people who may be in the prop-wash area behind the propeller. Stones, small pieces of metal, and sticks can become dangerous projectiles if kicked into the propeller during takeoff and landing. Just as with any airframe or wing component of a powered parachute, if the propeller becomes damaged, nicked or dinged, the aircraft's performance can be greatly affected.

Some pilots elect to use tape or rock deflector guards to protect the leading edge from rock/debris damage. Regardless, taking proper care of the PPC propeller is as critical as proper engine and wing care.

## Axle and Wheel Assembly

The rear and front wheels of the powered parachute are an assembly and consist of a tire, a rim, and an inner and outer set of wheel bearings. The wheel is secured on a spindle and held in place by a nut and a cotter pin. Each spindle is typically mounted on a suspension system which provides elasticity and at the same time is very strong. [Figure 3-18] The suspension system varies by manufacturer from one cart to another; refer to the POH for exact configuration and components. Some powered parachute tires are heavily treaded while others are smooth; pilot preference and the terrain type are determining factors in choice of tire profiles. [Figure 3-19] Tire sealant or thorn guards can be used to minimize flat tires.

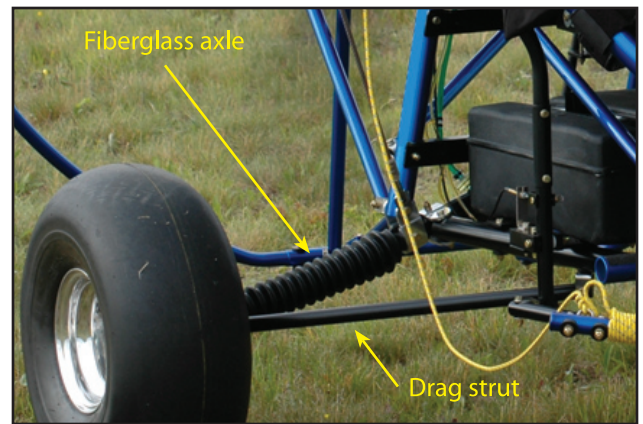

**Figure 3-18. Suspension system.**



**Figure 3-19. Some powered parachute tires are heavily treaded while others are smooth.**



# CHAPTER 4

## POWERPLANTS

This chapter covers the engines found on most powered parachutes and includes the exhaust, ignition, fuel, lubrication, cooling, propeller, gearbox, induction, charging, and fuel systems. Reciprocating engine operating theory is covered, for both two-stroke and four-stroke engines.

The powered parachute engine and propeller, often referred to as a powerplant, work in combination to produce thrust. The powerplant propels the powered parachute and charges the electrical system that supports PPC operation.

The engine is one of the key components of a powered parachute and should be maintained according to both the engine and airframe manufacturer recommendations. Preflight information, along with maintenance schedules and procedures, can be found in the *Pilot's Operating Handbook* (POH) and/or maintenance references from the manufacturers.

Engine inspections and maintenance must be performed and documented in a logbook. You should review this logbook before flying an unfamiliar powered parachute.

### Reciprocating Engines

Most powered parachutes are designed with reciprocating engines. Two common means of classifying reciprocating engines are:

1. By the number of piston strokes needed to complete a cycle: two-stroke or four-stroke; and
2. By the method of cooling: liquid or air-cooled.

Refer to Chapter 5 of the *Pilot's Handbook of Aeronautical Knowledge* for a comprehensive review of how reciprocating four-stroke engines operate.

### Two-Stroke Engines

Two-stroke engines are commonly used in powered parachutes. Two-stroke aviation engines evolved from two-stroke snowmobile and watercraft engines,

the difference being that an aircraft engine is optimized for reliability with dual ignition often installed for each cylinder. Two-stroke engines are popular because they have fewer components than four-stroke engines which makes them less expensive to manufacture, and lighter, thus increasing their power-to-weight ratio.

Two-stroke engines require that oil be mixed into the fuel to lubricate the engine, instead of being held in a sump and having a separate recirculating system like a four-stroke engine. Details on two-stroke oil mixing are covered later under the "Lubrication" section.

One stroke as the piston moves up is **intake** and **compression**, the second stroke as the piston moves down is **power** and **exhaust**. The two-stroke engine performs the same functions as a four-stroke engine in half the strokes.

A wide range of valve systems are found on two cycle engines, for the purpose of opening and closing ports in the cylinder to let fuel in and exhaust out at the proper time, similar to the intake and exhaust valves on a four-stroke engine. **One-way pressure valves**, called spring, reed, or poppet valves, open when the pressure drops within the crankcase, pulling the fuel from the carburetor into the crankcase. [Figure 4-1]

**Mechanical rotary valves** are driven off the engine, rotate to provide an opening at the precise time, and can be on the intake and exhaust ports. [Figure 4-2]

Piston porting does not use any valves. The fuel inlet port is opened and closed by the piston position as it moves up and down in the cylinder. This is called a "piston ported inlet" and will be used in the Two-Stroke Process description that follows. [Figure 4-3]

### Two-Stroke Process

The two-stroke process begins with the fuel entering the engine and concludes as it exits as exhaust. [Figure 4-3]

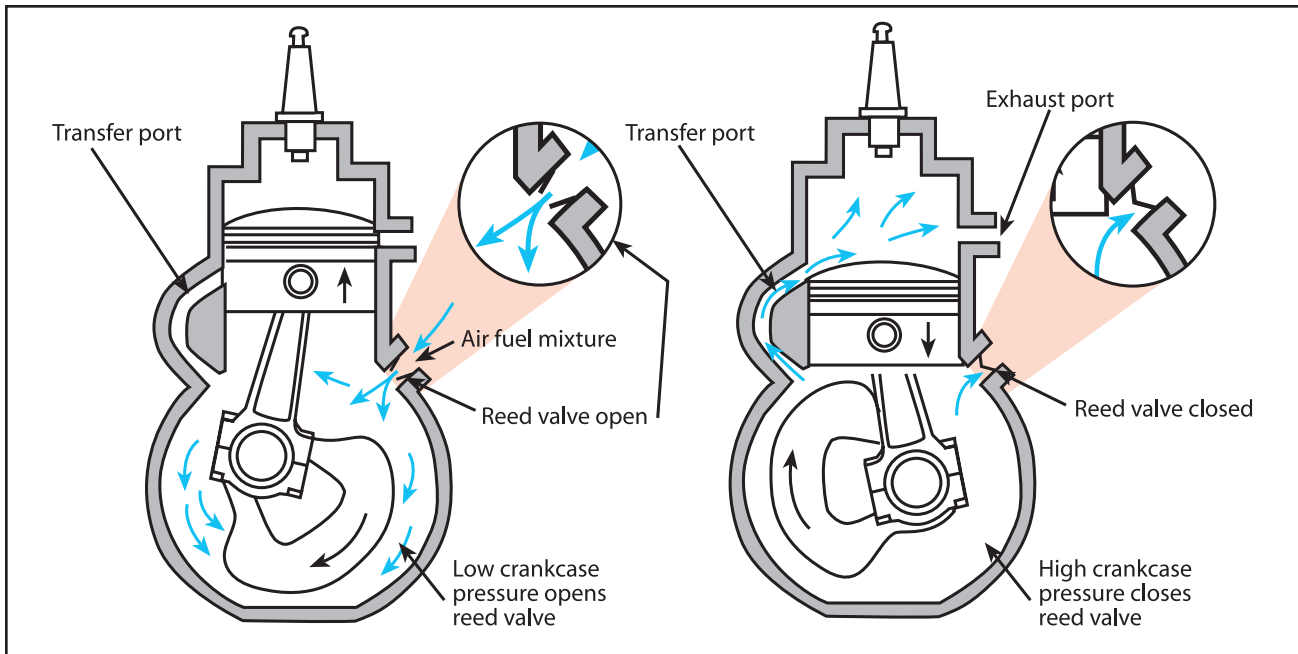

**Figure 4-1. Reed valve is open with low pressure and closes when the pressure increases.**

**Crankcase Vacuum Intake Stroke—Piston Moving up: Figure 4-3 a to b**

The upward stroke of the piston [Figure 4-3a] creates a vacuum in the crankcase and pulls the fuel/air/oil mixture into the crankcase through the intake valve system from the carburetor. [Figure 4-3b] This can be a pressure-actuated reed valve, a rotary valve, or a third ported inlet system where the lower piston skirt provides an opening for the fuel/air/oil mixture to flow in when the piston is reaching its highest point Top Dead Center (TDC). At this point, the greatest portion of the fuel/air/oil mixture has filled the crankcase.

**Crankcase Compression Stroke—Piston Moving down: Figure 4-3 b to c**

During the downward stroke, the pressure valve is forced closed by the increased crankcase pressure, the mechanical rotary valve closes, or the piston closes off the fuel/air/oil mixture intake port. The fuel mixture is then compressed in the crankcase during the downward stroke of the piston.

**Crankcase Transfer/Exhaust—Piston at lowest: Figure 4-3 d**

When the piston is near the bottom of its stroke, the transfer port opening from the crankcase to the combustion chamber is exposed, and the high pressure fuel/air mixture in the crankcase transfers around the piston into the main cylinder.

This fresh fuel/air/oil mixture pushes out the exhaust (called scavenging) as the piston is at its lowest point

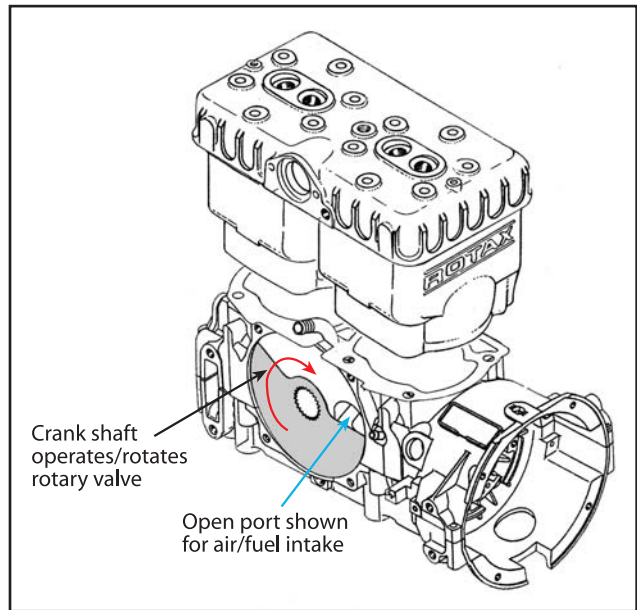
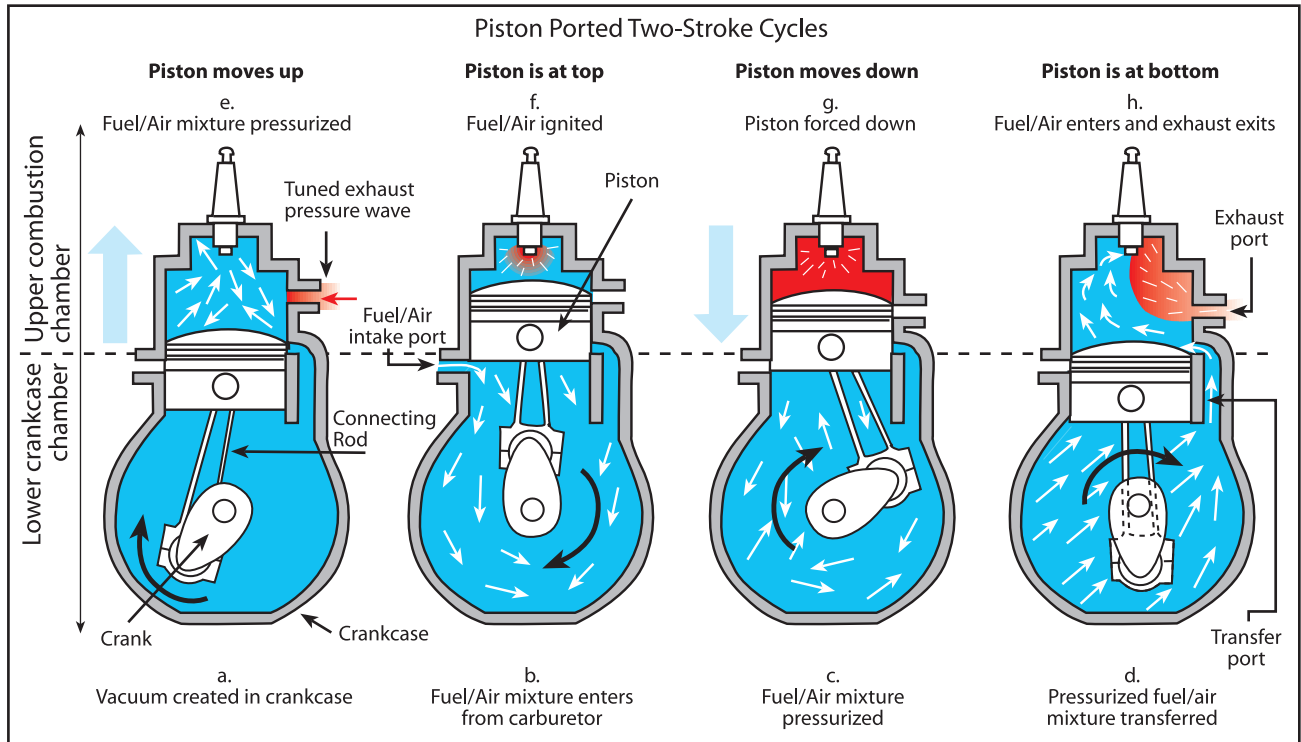

**Figure 4-2. Intake rotary valve for a two cycle engine.**

and the exhaust port is open. Some of the fresh fuel/air/oil mixture can escape out the exhaust port resulting in the higher fuel use of the two stroke engine.

**Cylinder start of Compression Stroke—Piston initially Moving up: Figure 4-3 e**

As the piston starts to move up, covering the transfer port, the tuned exhaust bounces a pressure wave at the precise time across the exhaust port (more on this in the exhaust system discussion) to minimize



**Figure 4-3. Piston ported inlet for a two cycle engine.**

the fuel/air/oil mixture from escaping out the exhaust port.

**Cylinder Compression Stroke—Piston Moving Up: Figure 4-3 e to f**

The piston then rises, and compresses the fuel mixture in the combustion chamber. During this piston compression process, the crankcase vacuum intake process is happening simultaneously, as described earlier. This is why four processes can happen in two strokes.

**Cylinder Power Stroke—Piston Moving Down: Figure 4-3 f to g**

At the top of the stroke, the spark plug ignites the fuel mixture and drives the piston down as the power stroke of the engine.

**Cylinder Power Stroke—Piston Moving Down: Figure 4-3 g to h**

As the piston passes the exhaust port, the exhaust starts to exit the combustion chamber. As the piston continues down, the transfer port opens and the swirling motion of the air/fuel/oil mixture pushes the exhaust out the exhaust port.

**Piston Reverses Direction From Down Stroke to Up Stroke: Figure 4-3 h to a**

As the piston reverses direction from the down stroke to the up stroke the process is complete.

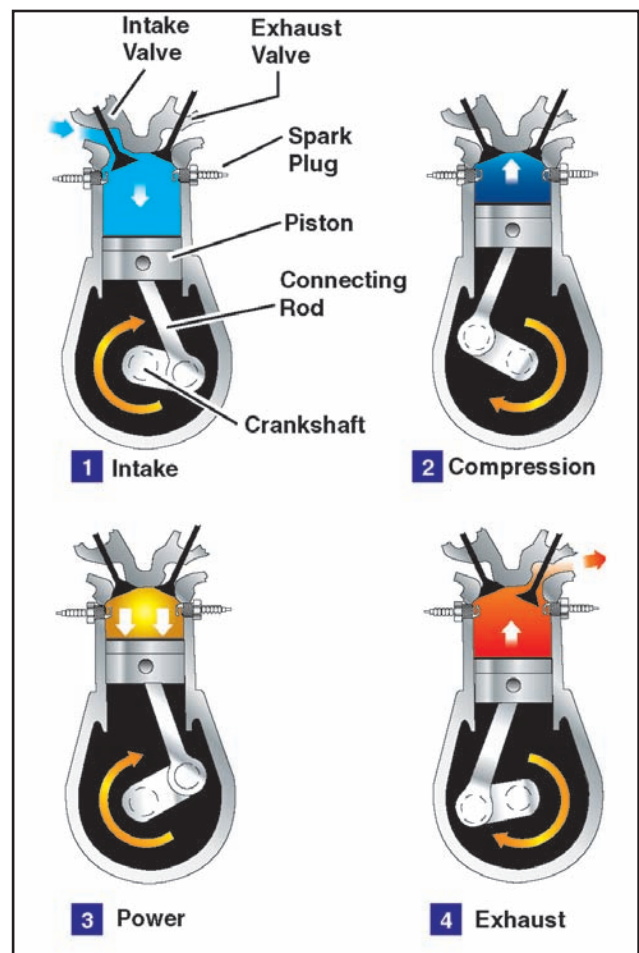

**Figure 4-4. The cycles in a four-stroke engine.**



## Four-Stroke Engines

Four-stroke engines are very common in most aircraft categories, and are becoming more common in powered parachutes. [Figure 4-4] Four-stroke engines have a number of advantages, including reliability, fuel economy, longer engine life, and higher horsepower ranges.

These advantages are countered by a higher acquisition cost, lower power-to-weight ratios, and a higher overall weight. The increased weight and cost are the result of additional components, e.g., camshaft, valves, complex head to house the valve train, etc., incorporated in a four-stroke engine.

## Exhaust Systems

Engine exhaust systems vent the burned combustion gases overboard, reduce engine noise, and (in the case of two-stroke engines) help keep the fresh fuel-air mixture in the cylinders. An exhaust system has exhaust piping attached to the cylinders, as well as a muffler. The exhaust gases are pushed out of the cylinder and through the exhaust pipe system to the atmosphere.

Some exhaust systems have an exhaust gas temperature probe. This probe transmits an electric signal to an instrument in front of the pilot. This instrument reads the signal and provides the exhaust gas temperature (EGT) of the gases at the exhaust manifold. This temperature varies with power and with the mixture (ratio of fuel to air entering the cylinders), and is used to make sure the fuel-air mixture is within specifications. When there is a problem with carburetion, the EGT gauge will normally be the first notification for a pilot.

### Two-Stroke Tuned Exhaust Systems

In two-stroke engines, the exhaust system increases the fuel economy and power of the engine. The two-stroke exhaust system is an integral part of any two-stroke engine design; often controlling peak power output, the torque curve, and even the RPM limit of the engine.

The exhaust system must be tuned to produce a back pressure wave to act as an exhaust valve. When hot spent gases are vented out of the exhaust port, they are moving fast enough to set up a high-pressure wave. The momentum of that wave down the exhaust pipe diffuser lowers the pressure behind it. That low pressure is used to help suck out all of the residual, hot, burnt gas from the power stroke and at the same time

help pull a fresh fuel-air charge into the cylinder. This is called scavenging and is an important function of a tuned two-stroke exhaust system.

The design of the exhaust converging section causes a returning pressure wave to push the fresh fuel-air charge back into the exhaust port before the cylinder closes off that port. That is called pulse-charging and is another important function of the exhaust system.

Tuned exhaust systems are typically tuned to a particular RPM range. The more a certain RPM range is emphasized, the less effective the engine will operate at other RPMs. Vehicles like motorcycles take advantage of this with the use of transmissions. Motorcycle exhaust pipe builders can optimize a certain RPM range and then the driver shifts gears to stay in that range. Aircraft, with no transmission, do not have this ability.

On an aircraft, an exhaust pipe has to be designed to operate over a broad range of RPMs from idle to full speed. This is part of the reason that simply putting a snowmobile engine on a powered parachute doesn't work well.

Overall, the two-stroke exhaust system for a PPC is a specific design and must be matched to the engine to operate properly and obtain the rated power. It also reduces noise and directs the exhaust to an appropriate location. Exhaust silencers can be added to reduce noise but additional weight, cost, and slight power reduction are the byproducts.

### Four-Stroke Engine Exhaust Systems

Four-stroke engines are not as sensitive as two-stroke engines because they have exhaust valves and therefore do not need the precision pulse tuned exhaust system. However, directing the exhaust out appropriately and reducing the noise are important considerations. Again, using the manufacturer's recommended configurations is required for Special Light Sport Aircraft (S-LSA) and recommended for Experimental Light Sport Aircraft (E-LSA).

## Two-Stroke Engine Warming

Two-stroke engines must be warmed up because metals expand at different rates as they heat up. If you heat up steel and aluminum, you will find that the aluminum parts expand faster than the steel parts. This becomes a problem in two different areas of many two-stroke engines. The first place is in the cylinders of the engine.

The cylinders have steel cylinder walls that expand slowly compared to aluminum pistons that expand quickly. If an engine is revved too quickly during takeoff before warming up, a lot of heat is generated on top of the piston. That quickly expands the piston, which can then seize in the cylinder. A piston seizure will stop the engine abruptly.

The second area of concern is lower in the engine around the engine crankshaft. This is an area where things may get too loose with heat, rather than seizing up. Additionally, the crankcase has steel bearings set into the aluminum which need to expand together or the bearings could slip.

Many two-stroke engines have steel bearings that normally hug the walls of the aluminum engine case. The crank spins within the donuts of those steel bearings. If you heat up the engine too quickly, the aluminum case will out-expand those steel bearings and the crank will cause the bearings to start spinning along with it. If those steel bearings start spinning, they can ruin the soft aluminum walls of the case, which is very expensive.

If heat is slowly added to an engine, all the parts will expand more evenly. This is done through a proper warm-up procedure. Many two-stroke engines are best warmed up by running the engine at a set RPM for a set amount of time. Follow the instructions in your POH; however, a good rule of thumb is to initially start the engine at idle RPM, get it operating smoothly, and then warm the engine at 3,000 RPM for 5 minutes.

Once the engine is warmed up and the powered parachute is flying, it is still possible to cool down the engine too much. This will happen when the engine is idled back for an extended period of time. Even though the engine is running, it is not generating as much heat as the cooling system is efficiently dumping into the atmosphere. An immediate power application with a cooled engine can seize the engine just as if the engine had not been warmed in the first place.

In water-cooled engines, on a long descent at idle, the coolant cools until the thermostat closes and the engine is not circulating the radiator fluid through the engine. The engine temperature remains at this thermostat closed temperature while the radiator coolant continues to cool further. If full throttle is applied, the thermostat can open allowing a blast of coolant into the warm engine. The piston is expanding because of the added heat and the cylinder is cooling with the cold radiator water resulting in a piston seizure. To

prevent this, slowly add power well before you get close to the ground where you will need power. This will give the system a chance to gradually open the thermostat and warm up the radiator water.

Just as it takes a while for the engine crankcase and bearings to warm up, it also takes those steel parts a long time to cool down. If you land, refuel and want to take off again quickly, there is no need to warm up again for 5 minutes. The lower end of the engine will stay warmed up after being shut down for short periods. An engine restart is an example where it would be appropriate to warm the engine up until the gauges reach operating temperatures. The lower end of the engine is warm and now you only need to be concerned with preventing the pistons from seizing.

## **Four-Stroke Engine Warming**

A four-stroke engine must also be warmed up. The four-stroke engine has a pressurized oil system that provides more uniform engine temperatures to all its components. You can apply takeoff power as soon as the water, cylinder head temperature (CHT), oil temperatures and oil pressure are within the manufacturer's recommended tolerances for takeoff power applications.

## **Gearboxes**

Gearboxes are used on all powered parachute reciprocating engines to take the rotational output of an internal combustion engine which is turning at a very high RPM and convert it to a slower (and more useful) RPM to turn the propeller. Gearboxes come in different gear ratios depending on the output speed of the engine and the needed propeller turning speeds.

A typical two-stroke RPM reduction is from 6,500 engine RPM with a 3.47 to 1 reduction, resulting in 1,873 propeller RPM. A typical four-stroke RPM reduction is from 5,500 engine RPM with a 2.43 to 1 reduction, resulting in 2,263 propeller RPM.

A gearbox is a simple device that bolts directly to the engine and in turn has the propeller bolted directly to it.

A two-cycle engine gearbox is kept lubricated with its own built-in reservoir of heavy gearbox oil. The reservoir is actually part of the gearbox case itself. The gearbox oil has to be changed periodically since the meshing of the gears will cause them to wear and will deposit steel filings into the oil. If the oil is not

changed, the filings themselves are abrasive and will cause even more wear.

Some gearboxes have the electric starter motor built into it. When activated, the motor turns the gearing, which in turn cranks the engine itself.

Four-stroke propeller reduction gearboxes use oil from the engine oil system for lubrication.

### Centrifugal Clutch

Some gearboxes come with a built-in centrifugal clutch, and others have allowances for installation. A centrifugal clutch is very useful in a two-stroke engine because it allows the engine to idle at a lower speed without the load of the propeller. Otherwise, two-strokes can generate a lot of vibration at low RPM when loaded. As the engine speeds up, the centrifugal clutch engages the rest of the gearbox and smoothly starts the propeller spinning. When the engine is brought back to idle, the clutch disengages and allows the engine to again idle smoothly; the propeller stops when on the ground and windmills when flying.

### Propeller

The propeller provides the necessary thrust to push the powered parachute through the air. The engine power is used to rotate the propeller, which in turn generates thrust very similar to the manner in which a wing produces lift. The amount of thrust produced depends on the airfoil shape, the propeller blade angle of attack, and the engine RPM. [Figure 4-5] Powered parachutes are equipped with either a fixed-pitch or ground adjustable pitch propeller.

### Fixed-Pitch Propeller

The pitch of this propeller is set by the manufacturer and cannot be changed. Refer to Chapter 5 of the *Pilot's Handbook of Aeronautical Knowledge* for basic propeller principles.

### Ground Adjustable-Pitch Propeller

Adjustable-pitch propellers for PPCs can only be adjusted on the ground with hand tools. If an engine is over-revving, more pitch can be added to the propeller. If the engine is not developing the full recommended RPM during flight, then some pitch can be taken out of the blades. This should be done per the PPC's POH and by a qualified technician.

### Induction Systems

The induction system brings air in from the atmosphere, mixes it with fuel, and delivers the fuel-air



Figure 4-5. Engine RPM is indicated on the gauge.

mixture to the cylinder where combustion occurs. Outside air enters the induction system through an air filter on the engine. The air filter inhibits the entry of dust and other foreign objects. Two types of induction systems are used in powered parachute engines:

1. The carburetor system is most common; it mixes the fuel and air in the carburetor before this mixture enters the engine intake, and
2. The fuel injection system, which injects the fuel into the air just before entry into each cylinder.

### Carburetor Systems

PPCs use float-type carburetors. Reference the *Pilot's Operating Handbook of Aeronautical Knowledge* for basics on float carburetor operation.

Modern two- and four-stroke carburetors operate with one of three jetting systems, depending on engine power. [Figure 4-6]

When the throttle is closed, for engine idling, the throttle valve is closed and the fuel is supplied through the idle (pilot) jet and idle (pilot) air passage. The fuel/

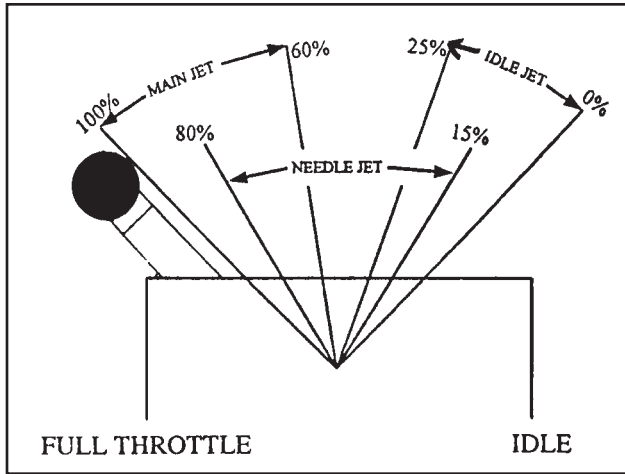

**Figure 4-6. Throttle position and jetting system used.**

air/oil mixture is supplied to the cylinders through the bypass hole. [Figure 4-7]

As the throttle is advanced and the throttle valve is raised, the fuel is sucked up through the main jet but is controlled by the opening and taper of the jet needle and needle jet. This is effective throughout most of the mid range operation. About half throttle, the main jet size starts to influence the amount of fuel mixed with the air and this effect continues until it is the main influence at the highest throttle settings. [Figure 4-8]

### Two-Stroke Carburetor Jetting

Carburetors are normally set at sea-level pressure, with the jets and settings determined by the manufacturer. [Figure 4-9] However, as altitude increases, the



**Figure 4-9. Typical 2-stroke carburetor.**

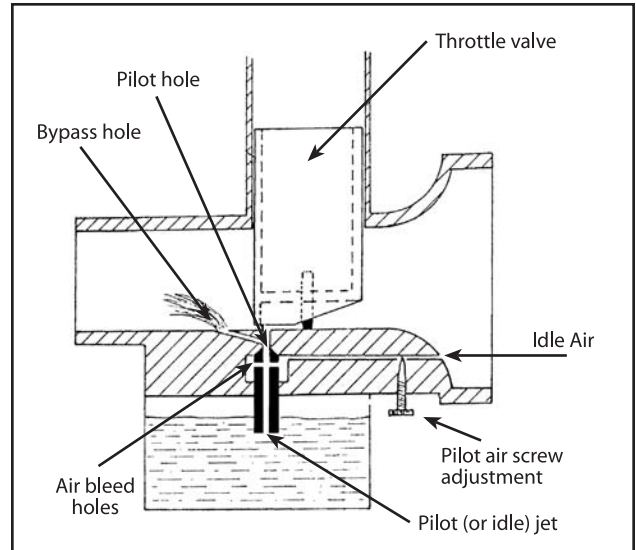

**Figure 4-7. Pilot or Idle jet system.**

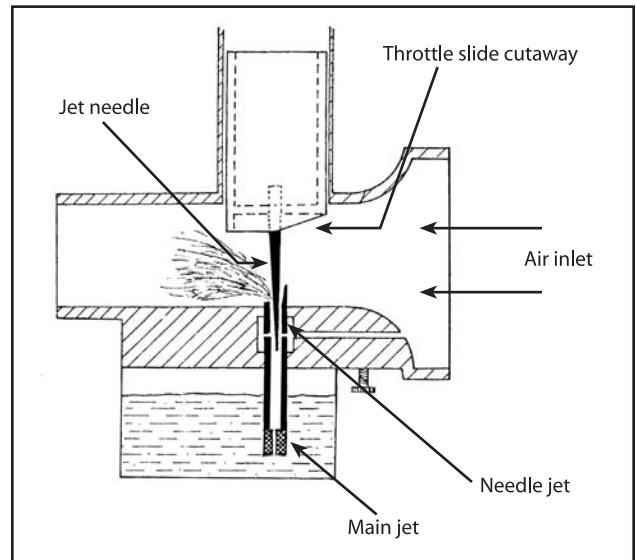

**Figure 4-8. Jet needle/needle jet and main jet system.**

density of air entering the carburetor decreases, while the density of the fuel remains the same. This creates a progressively richer mixture, same fuel but less air, which can result in engine roughness and an appreciable loss of power. The roughness is usually due to spark plug fouling from excessive carbon buildup on the plugs. Carbon buildup occurs because the excessively rich mixture lowers the temperature inside the cylinder, inhibiting complete combustion of the fuel. This condition may occur at high-elevation airports and during climbs or cruise flight at high altitudes. To maintain the correct fuel-air mixture, you can change the main jets and the midrange jets setting for base operations at a high density altitude airport. Operating from low altitude airports and climbing to altitude where the mixture becomes rich for short periods is OK.

Operating an aircraft at a lower altitude airport with the jets set for higher altitudes will create too lean of a mixture, heat up the engine, and cause the engine to seize. The pilot must be aware of the jetting for the machine to adjust the mixture. Consult your POH for specific procedures for setting jets at different altitudes.

### Four-Stroke Mixture Settings

Four-stroke engines typically have automatic mixture control for higher altitudes or a mixture control that can be operated by the pilot.

### Carburetor Icing

One disadvantage of the carburetor system versus the fuel injected system is its icing tendency. Carburetor ice occurs due to the effect of fuel vaporization and the decrease in air pressure in the venturi, which causes a sharp temperature drop in the carburetor. If water vapor in the air condenses when the carburetor temperature is at or below freezing, ice may form on internal surfaces of the carburetor, including the throttle valve.

Ice generally forms in the vicinity of the venturi throat. This restricts the flow of the fuel-air mixture and reduces power. If enough ice builds up, the engine may cease to operate. Carburetor ice is most likely to occur when temperatures are below 70°F (21°C) and the relative humidity is above 80 percent. However, due to the sudden cooling that takes place in the carburetor, icing can occur even with temperatures as high as 100°F (38°C) and humidity as low as 50 percent. This temperature drop can be as much as 60 to 70°F. Therefore, at an outside air temperature of 100°F, a temperature drop of 70°F results in an air temperature in the carburetor of 30°F. [Figure 4-10]

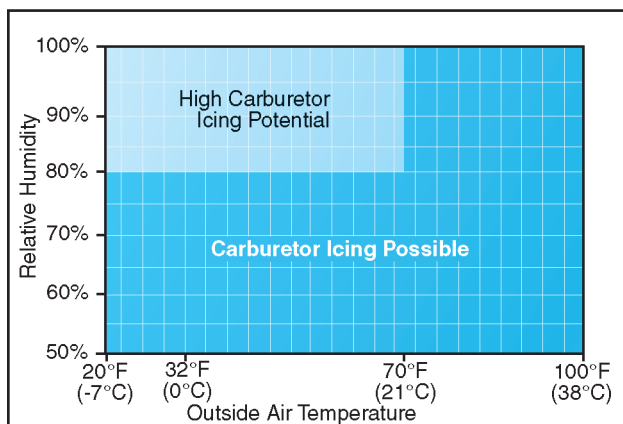

**Figure 4-10.** Although carburetor ice is most likely to form when the temperature and humidity are in ranges indicated by this chart, carburetor ice is also possible under conditions not depicted.

The first indication of carburetor icing in a powered parachute is a decrease in engine RPM, which may be followed by engine roughness. Although carburetor ice can occur during any phase of flight, it is particularly dangerous when using reduced power during a descent. Under certain conditions, carburetor ice could build unnoticed until you try to add power. To combat the effects of carburetor ice, some engines have a carb heat option. Some of the newer four-stroke engines have carburetor heat turned on all the time to combat icing. Two-stroke engines are typically less susceptible to icing but specific installations dictate how susceptible the carburetor is to icing. Consult the aircraft POH for the probability of carb ice for the specific installation you have and for carb ice procedures.

### Fuel Injection Systems

In a fuel injection system, the fuel is injected either directly into the cylinders, or just ahead of the intake valve. A fuel injection system usually incorporates these basic components: an engine-driven fuel pump, a fuel-air control unit, fuel manifold (fuel distributor), discharge nozzles, an auxiliary fuel pump, and fuel pressure/flow indicators. [Figure 4-11]

The auxiliary fuel pump provides fuel under pressure to the fuel-air control unit for engine starting and/or emergency use. After starting, the engine-driven fuel pump provides fuel under pressure from the fuel tank to the fuel-air control unit. This control unit, which essentially replaces the carburetor, meters the fuel and sends it to the fuel manifold valve at a rate controlled by the throttle. After reaching the fuel manifold valve, the fuel is distributed to the individual fuel discharge nozzles. The discharge nozzles, which are located in each cylinder head, inject the fuel-air mixture directly into each cylinder intake port.

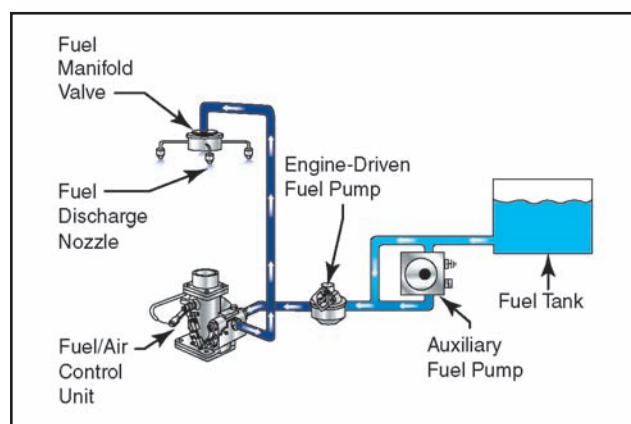

**Figure 4-11.** Fuel injection system.

Some of the advantages of fuel injection are:

- No carburetor icing.
- Better fuel flow.
- Faster throttle response.
- Precise control of mixture.
- Better fuel distribution.
- Easier cold weather starts.

Disadvantages include:

- Difficulty in starting a hot engine.
- Vapor locks during ground operations on hot days.
- Problems associated with restarting an engine that quits because of fuel starvation.

## Ignition System

The ignition system provides the spark that ignites the fuel-air mixture in the cylinders. Components include a magneto generator, an electronic control box that replaces mechanical points, spark plugs, high-voltage leads and the ignition switch(es). Individual manufacturer designs will vary and pilots must be familiar with the aircraft operating procedures for the PPC being flown.

A magneto uses a permanent magnet to generate an electrical current independent of the aircraft's electrical system which might include a battery. The aircraft electrical system can fail—the battery can go dead—however, this has no effect on the ignition system which uses a separate generator in the magneto. The electricity from the separate ignition coil on the magneto generator goes into the ignition control box where the correct voltage is produced and timed to fire the spark plugs at the proper time. The magneto also sends a signal to the electric control box to provide the timing signal to fire the spark plugs.

Most modern PPCs use an electronic timing system instead of the mechanical points inside the old magnetos which also housed the points. Capacitor discharge ignition (CDI) systems are a common example of an electronic ignition system. Electronic ignition systems operate without any moving parts to increase reliability and efficiency. A CDI system begins to fire when the starter is engaged and the crankshaft begins to turn. It continues to operate whenever the crankshaft is rotating.

Most powered parachutes incorporate a dual ignition system with two individual coil systems in the magneto, two individual electronic ignition timing systems (electric box), two separate sets of wires, and

two spark plugs per cylinder. Dual ignition systems increase overall reliability of the engine. Each ignition system operates independently to fire one of the two spark plugs. If one ignition system fails, the other is unaffected. The engine will continue to operate normally, although you can expect a slight decrease in engine power.

The operation of the ignition system is controlled in the cockpit by the ignition switch(es). Since there are two individual ignition systems, there are normally two separate ignition toggle switches.

You can identify a malfunctioning ignition system during the pretakeoff check by observing the decrease in RPM that occurs when you first turn off one ignition switch, turn it back on, and then turn off the other. A noticeable decrease in engine RPM is normal during this check. If the engine stops running when you switch to one ignition system or if the RPM drop exceeds the allowable limit, do not fly the powered parachute until the problem is corrected. The cause could be fouled plugs, broken or shorted wires between the magneto and the plugs, or improperly timed firing of the plugs because of the control box.

It should be noted that “no drop” in RPM is not normal, and in that instance, the powered parachute should not be flown. Following engine shutdown, keep the ignition switches in the OFF position. Even with the battery and master switches OFF, the engine can fire and turn over if you leave an ignition switch ON and the propeller is moved because the ignition system requires no outside source of electrical power. The potential for serious injury in this situation is obvious.

## Combustion

During normal combustion, the fuel-air mixture burns in a very controlled and predictable manner. Although the process occurs in a fraction of a second, the mixture actually begins to burn at the point where it is ignited by the spark plugs, then burns away from the plugs until it is consumed completely. This type of combustion causes a smooth buildup of temperature and pressure and ensures that the expanding gases deliver the maximum force to the piston at exactly the right time in the power stroke.

Detonation is an uncontrolled, explosive ignition of the fuel-air mixture within the cylinder's combustion chamber. It causes excessive temperatures and pressures which, if not corrected, can quickly lead to failure of the piston, cylinder, or valves. In less severe

cases, detonation causes engine overheating, roughness, or loss of power.

Detonation is characterized by high cylinder head temperatures, and is most likely to occur when operating at high power settings. Some common operational causes of detonation include:

- Using a lower fuel grade than that specified by the aircraft manufacturer or operating the engine after it has been sitting for an extended period; after 3 weeks or as indicated by your POH you should drain old fuel out and replenish with fresh fuel.
- Operating the engine at high power settings with an excessively lean mixture.
- Detonation also can be caused by extended ground operations.

Detonation may be avoided by following these basic guidelines during the various phases of ground and flight operations:

- Make sure the proper grade of fuel is being used. Drain and refuel if the fuel is old.
- Develop a habit of monitoring the engine instruments to verify proper operation according to procedures established by the manufacturer.

Preignition occurs when the fuel-air mixture ignites prior to the engine's normal ignition event. Premature burning is usually caused by a residual hot spot in the combustion chamber, often created by a small carbon deposit on a spark plug, a cracked spark plug insulator, or other damage in the cylinder that causes a part to heat sufficiently to ignite the fuel-air charge. Preignition causes the engine to lose power, and produces high operating temperature. As with detonation, preignition may also cause severe engine damage, because the expanding gases exert excessive pressure on the piston while still on its compression stroke.

Detonation and preignition often occur simultaneously and one may cause the other. Since either condition causes high engine temperature accompanied by a decrease in engine performance, it is often difficult to distinguish between the two. Using the recommended grade of fuel and operating the engine within its proper temperature and RPM ranges reduce the chance of detonation or preignition.

## Fuel Systems

The fuel system is designed to provide an uninterrupted flow of clean fuel from the fuel tank to the engine. See Chapter 3 for more information on fuel tanks. The

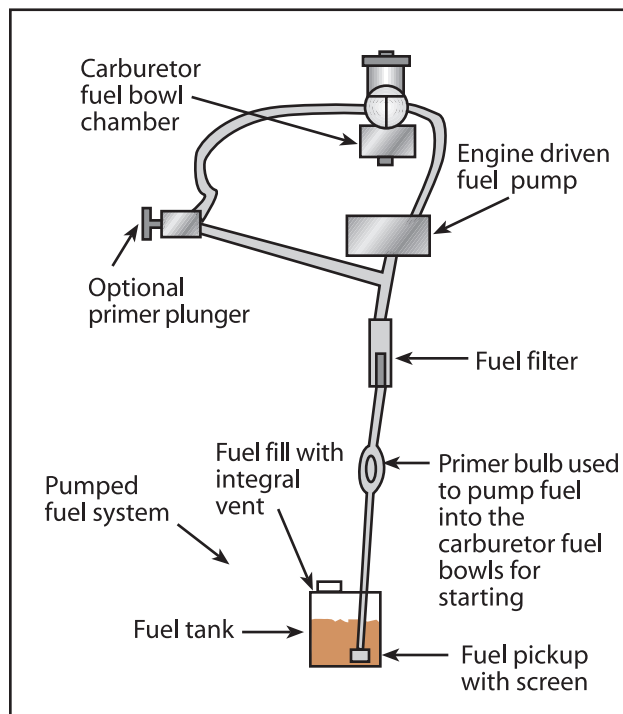

**Figure 4-12. Fuel pump system.**

fuel must be available to the engine under all conditions of engine power, altitude, attitude, and during all approved flight maneuvers. [Figure 4-12]

### Fuel Pumps

Powered parachutes have fuel pump systems. The main pump system is engine-driven and sometimes an electrically-driven auxiliary pump is provided for use in engine starting and in the event the engine pump fails. The auxiliary pump, also known as a boost pump, provides added reliability to the fuel system. The electrically-driven auxiliary pump is controlled by a switch in the cockpit.

A diaphragm pump is the primary pump in the fuel system for two-stroke engines. Air pulses in the crankcase actuate a diaphragm and provide fuel under pressure to the carburetor. Four-stroke engines have a mechanical pump driven directly off the engine.

### Fuel Plunger Primer

The fuel plunger primer is used to draw fuel from the tanks to supply it directly into the cylinders prior to starting the engine. This is particularly helpful during cold weather when engines are hard to start because there is not enough heat available to vaporize the fuel in the carburetor. For some powered parachutes, it is the only way to deliver fuel to the engine when first starting. After the engine starts and is running, the fuel pump pushes fuel to the carburetors and begins

normal fuel delivery. To avoid overpriming, read the priming instructions in your POH for your powered parachute.

### **Choke**

A choke or fuel enriching system is an alternate method to provide additional fuel to the engine for initial cold starting. Actuating the choke control allows more fuel to flow into the carburetor.

### **Fuel Bulb Primer**

The fuel bulb primer is manually actuated by squeezing the bulb to draw fuel from the tanks. This charges the fuel lines and carburetor float bowls before starting the engine the first time on a given day. After the engine starts, the fuel pump is able to deliver the fuel to the fuel bowls.

### **Fuel Gauges**

The fuel quantity gauge indicates the amount of fuel measured by a sensing unit in each fuel tank and is displayed in gallons. Do not depend solely on the accuracy of the fuel quantity gauge. Always visually check the fuel level in the tank during the preflight inspection, and then compare it with the corresponding fuel quantity indication. It is also important to track your inflight fuel consumption. Be sure to consult the POH for your powered parachute and know the approximate consumption rate to ensure sufficient fuel for your flight.

If an auxiliary electric fuel pump is installed in the fuel system, a fuel pressure gauge is sometimes included. This gauge indicates the pressure in the fuel lines. The normal operating pressure can be found in the POH.

### **Fuel Filter**

After leaving the fuel tank, the fuel passes through a filter before it enters the fuel pump or carburetor. This filter removes sediments that might be in the fuel.

## **Fuel**

Aviation gasoline, or AVGAS, is identified by an octane or performance number (grade), which designates the antiknock value or knock resistance of the fuel mixture in the engine cylinder. The higher the grade of gasoline, the more pressure the fuel can withstand without detonating. Lower grades of fuel are used in lower-compression engines because these fuels ignite at a lower temperature. Higher grades are used in higher-compression engines, because they must ignite at higher temperatures, but not prematurely. If

the proper grade of fuel is not available, use the next higher grade as a substitute. Never use a lower grade. This can cause the cylinder head temperature to exceed its normal operating range, which may result in detonation.

Unfortunately, aviation gasoline or AVGAS 100LL is not recommended by at least one of the major two-stroke engine manufacturers. Even though the “LL” stands for “Low Lead,” 100LL contains more lead than the old premium leaded gas dispensed at automotive filling stations. The lead in the fuel leaves deposits in the piston ring grooves, freezing the rings in position and reducing engine performance.

Spark plugs are also very susceptible to lead fouling. This is especially true in two-stroke engines that use cooler ignition temperatures than standard aircraft engines.

AVGAS does have some advantages. It degrades slower than regular gas, maintaining its efficiency for a full 3 months. AVGAS 100LL has no seasonal or regional variations and is manufactured according to a standardized “recipe” worldwide.

If the airport has only 100LL available, it is permissible, absent any limitations of the engine manufacturer, to mix 100LL and 89 octane gasoline, for use in two-stroke engines. A 50-50 ratio will boost the octane rating and limit the amount of lead available for fouling. Generally speaking, this is a reasonable compromise when 89 octane is not available.

Two-stroke engine manufacturers, and four-stroke engines used on powered parachutes, typically recommend the use of 89 octane minimum auto fuel for their engines. Additives are put into auto gas primarily to reduce harmful emissions rather than boost performance. The additives are supposed to be listed at the pump, but the accuracy of this posting should be questioned.

Methanol alcohol has corrosive properties and can damage engines. Engine manufacturers do not recommend more than 3 percent methanol in fuel. Consult the POH for specifics on your engine.

Ethanol alcohol is less corrosive than methanol. However, it attracts water and is not as economical as gasoline. Ethanol does not get very good fuel economy. Avoid fuels with any more than 10 percent of ethanol in it. Consult your POH for specifics on your engine.

Manufacturers provide specific recommendations for the percentage of alcohol in fuel. The posting on the



pump may not be accurate and alcohol content can vary greatly between fuel brands and stations. Additionally, higher percentages of alcohol will be added to auto gas in the future. A simple test can be conducted to measure the fuel's alcohol content to ensure the fuel you use stays within the manufacturer's recommendations.

Use a general aviation sump collector, which includes graduation marks. Add water to a specific mark. Then add fuel to fill the collector up to the line for gas. Cover the top and shake it vigorously. After it settles, the water and alcohol will combine and it will look like there is now more water in the sump collector. The difference between the initial amount of water you first put into the collector and the new level of combined water and alcohol equals the amount of alcohol in the fuel. Compare this amount of alcohol and the amount of fuel to determine the percentage of alcohol content in the fuel.

Methyl Tertiary Butyl Ether (MTBE) does not have the corrosive or water attractive properties of the previously mentioned additives and is added to fuel to improve air quality. It has been banned in several states because it is carcinogenic and has been found in groundwater. It does not attract water, but it is expensive, so you will find it only in some of the better grade fuels.

### **Fuel Contamination**

Clean fuel is imperative for the safe operation of a PPC. Of the accidents attributed to powerplant failure from fuel contamination, most have been traced to:

- Failure to remove contamination from the fuel system during preflight.
- Servicing aircraft with improperly filtered fuel from small tanks or drums.
- Storing aircraft with partially filled fuel tanks.
- Lack of proper maintenance.

Rust is common in metal fuel containers and is a common fuel contaminant. Metal fuel tanks should be filled after each flight, or at least after the last flight of the day to prevent moisture condensation within the tank. Another way to prevent fuel contamination is to avoid refueling from cans and drums. Use a water filtering funnel or a funnel with a chamois skin when refueling from cans or drums. However, the use of a chamois will not always ensure decontaminated fuel. Worn-out chamois will not filter water; neither will a new, clean chamois that is already water-wet or damp. Most imitation chamois skins will not filter water.

### **Bad Gasoline**

Letting fuel sit for weeks without using it will cause it to go bad. Even if gas does not go bad, it will often lose its octane with time. For those that premix gasoline and two-stroke oil, there is another set of problems. Fuel and oil are normally mixed at a 50:1 ratio. If premixed gas sits in a plastic container for a while, the gas will evaporate out leaving a richer oil mixture in the container. In any case, fresh gas should be used as much as possible.

### **Refueling Procedures**

Never mix oil and fuel in an enclosed area. Not only are the fumes irritating, but with the right fuel-air mixture you can cause an explosion. Do all oil and gas mixing outside. Refueling from fuel cans should also be done outside. Never smoke while refueling.

Be careful refueling an aircraft that has just landed. There is the danger of spilling fuel on a hot engine component, particularly an exhaust system component.

Refueling should be done using only safety-approved fuel containers. The fuel containers should be marked with the type of fuel stored in them. Confusing premixed fuel and fuel that has no oil in it can be disastrous.

There are advantages to both metal and plastic containers. Metal cans won't allow the sun's ultraviolet rays in to harm the fuel. It also won't develop static charges like a plastic container may. However, a metal can will be more prone to sweating when going from cool to warm temperatures on humid days. Metal cans and metal gas tanks are best kept either empty, or full of fuel to leave no room for moist air.

Plastic fuel containers are easy to handle, inexpensive, available at discount stores, and do not scratch the finish on airframes. Plastic cans also do not sweat, so they don't need to be stored topped off. However, fuel does deteriorate a little faster in plastic. Also, plastic containers can get charged with static electricity while sliding around in the bed of a pickup truck, especially if the truck has a plastic bed liner. Many states now have laws prohibiting people from filling plastic containers unless first placed on the ground.

Static electricity can also be formed by the friction of air passing over the surfaces of a powered parachute in flight and by the flow of fuel through the hose and nozzle during refueling, if fueling at a pump. Nylon, Dacron, and wool clothing are especially prone to accumulate and discharge static electricity from the

person to the funnel or nozzle. To guard against the possibility of static electricity igniting fuel fumes, a ground wire should be attached to the aircraft before the fuel cap is removed from the tank. The refueling nozzle should then be grounded to the aircraft before refueling is begun, and should remain grounded throughout the refueling process.

The passage of fuel through a chamois increases the charge of static electricity and the danger of sparks. The aircraft must be properly grounded and the nozzle, chamois filter, and funnel bonded to the aircraft. If a can is used, it should be connected to either the grounding post or the funnel. Cell phones should not be used while refueling as they could pose a fire risk.

### Mixing Two-Stroke Oil and Fuel

Two-stroke engines require special two-stroke oil to be mixed into the fuel before reaching the cylinder of the engine. In some engines, an oil injection pump is used to deliver the exact amount of oil into the intake of the engine depending on the throttle setting. An advantage of an oil injection system is pilots don't have to premix any oil into the fuel. However, an important preflight check is to make sure the two-stroke oil reservoir is properly filled.

If a two-stroke engine doesn't have an oil injection system, it is critical to mix oil into fuel before it is put into the tank. Just pouring oil into the fuel tank doesn't give it the proper chance to mix with the gas and makes it difficult to measure the proper amount of oil for mixing. To mix two-stroke oil you should:

- Find a clean, approved container. Pour a little gas into it to help pre-dilute the two-stroke oil.
- Pour in a known amount of two-stroke oil into the container. Oil should be approved for air-cooled engines at 50:1 mixing ratio (check the engine manufacturer for proper fuel to oil ratio for your PPC). Use a measuring cup if necessary. Shake the oil-gas mixture around a little to dilute the oil with gasoline.
- Add gasoline until the 50:1 ratio is reached. If you choose to use a water separating funnel, make sure the funnel is grounded or at least in contact with the fuel container.
- Put the cap on the fuel can and shake the gasoline and oil mixture thoroughly.

### Starting System

Most small aircraft use a direct-cranking electric starter system. This system consists of a source of

electricity, wiring, switches, and solenoids to operate the starter and a starter motor. The starter engages the aircraft flywheel or the gearbox, rotating the engine at a speed that allows the engine to start and maintain operation.

Electrical power for starting is usually supplied by an on-board battery. When the battery switch is turned on, electricity is supplied to the main power bus through the battery solenoid. Both the starter and the starter switch draw current from the main bus, but the starter will not operate until the starting solenoid is energized by the starter switch being turned to the "start" position. When the starter switch is released from the "start" position, the solenoid removes power from the starter motor. The starter motor is protected from being driven by the engine through a clutch in the starter drive that allows the engine to run faster than the starter motor.

### Oil Systems

In a four-stroke engine, the engine oil system performs several important functions, including:

- Lubrication of the engine's moving parts.
- Cooling of the engine by reducing friction.
- Removing heat from the cylinders.
- Providing a seal between the cylinder walls and pistons.
- Carrying away contaminants.

Four-stroke engines use either a wet-sump or dry-sump oil system. Refer to Chapter 5 of the *Pilot's Handbook of Aeronautical Knowledge* for more information on four-stroke oil systems.

### Engine Cooling Systems

The burning fuel within the cylinders produces intense heat, most of which is expelled through the exhaust system. Much of the remaining heat, however, must be removed, or at least dissipated, to prevent the engine from overheating.

While the oil system in a four-stroke engine and the fuel-oil mix in a two-stroke engine is vital to the internal cooling of the engine, an additional method of cooling is necessary for the engine's external surface. Powered parachute engines operate with either air-cooled or liquid-cooled systems.

Many powered parachutes are equipped with a cylinder head temperature (CHT) gauge. This instrument indicates a direct and immediate cylinder temperature

change. This instrument is calibrated in degrees Celsius or Fahrenheit. Proper CHT ranges can be found in the pilot's operating handbook for that machine.

Air cooling is accomplished by air being pulled into the engine shroud by a cooling fan. Baffles route this air over fins attached to the engine cylinders where the air absorbs the engine heat. Expulsion of the hot air takes place through one or more openings in the shroud. If cylinder head temperatures rise too much in an air cooled engine, it is because of lubrication problems: cooling fan drive belt damage or wear, or air blockage in the cooling fins by a bird or insect nest.

Liquid cooling systems pump coolant through jackets in the cylinders and head. The heated liquid is then routed to a radiator where the heat is radiated to the atmosphere. The cooled liquid is then returned to the engine. If the radiator is mounted low and close to the propeller, the propeller can constantly move air across the radiator and keep the engine cool even when the powered parachute is not moving. Radiators mounted high and away from the propeller raise the center of gravity and make it more difficult for the radiator to

cool the engine unless the powered parachute is moving. Breaking in an engine through ground runs on a hot day is when radiator placement is most critical.

Liquid-cooled engines can overheat for a number of reasons, such as coolant not at proper levels, a leak, a failed water pump, or a blockage of the radiator. Operating an engine above its maximum design temperature can cause a loss of power and detonation. It will also lead to serious permanent damage, such as scoring the cylinder walls and damaging the pistons and rings. Monitor the engine temperature instruments to avoid high operating temperature.

Operating the engine lower than its designed temperature range can cause piston seizure and scarring on the cylinder walls. This happens most often in liquid-cooled powered parachutes in cold weather where large radiators designed for summer flying may need to be partially blocked off.

# CHAPTER 5

## PREFLIGHT AND GROUND OPERATIONS

### Get Ready to Fly

Your preflight preparations should include evaluating the airworthiness of the:

- **Pilot:** experience, sleep, food and water, drugs/medications, stress, illness
- **Aircraft:** fuel, weight (does not exceed maximum), density altitude, takeoff and landing requirements, equipment
- **EnVironment:** weather conditions and forecast for departure and destination airfields and route of flight, runway lengths
- **External pressures:** schedules, available alternatives, purpose of flight

Often remembered as PAVE, it is important for you to consider each of these factors and establish your own personal minimums for flying.

Once you determine the PAVE factors are favorable for flight, you should obtain a weather briefing, check

Notices to Airmen (NOTAMs) and Terminal Flight Restrictions (TFRs), plan your flight (determine the departure and destination airfield and route of flight), file a flight plan (if planning to fly cross-country), and head to your aircraft and point of departure. The powered parachute (PPC) may be stored in a hangar, garage, or covered trailer—any place out of the weather. Begin with a visual inspection of the cart, then warm up the engine. Push or taxi the PPC to the takeoff point, shut down the engine, lay out and inspect the wing. Finally, strap into the PPC, start the engine, kite the wing, and then continue the takeoff roll to lift off. [Figure 5-1]

### Trailer

Trailers may be used to transport, store, and retrieve powered parachutes. The PPC components should fit snugly without being forced, be guarded against chafing, and be well secured within the trailer. Once

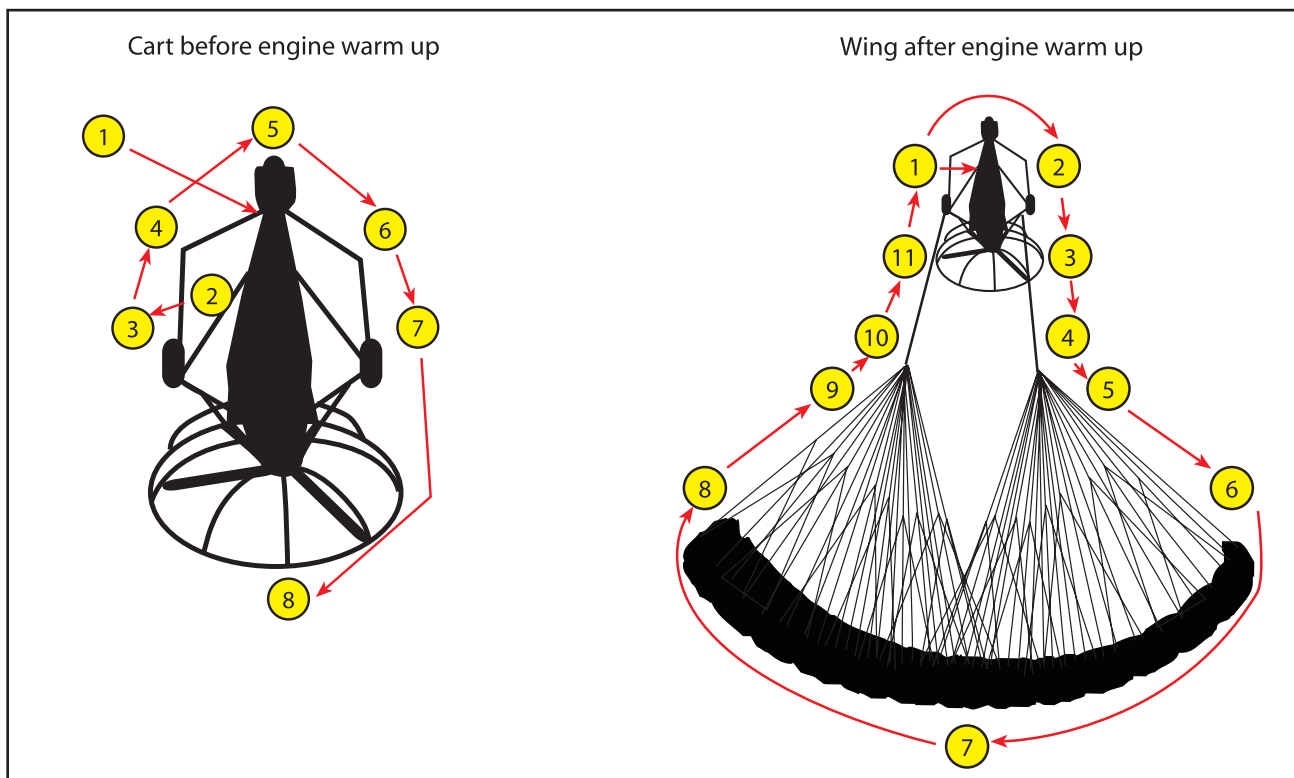

Figure 5-1. Typical sequence for a preflight inspection. Use the preflight checklist in your POH for every flight.

the loading is completed, take a short drive, stop, and check for rubbing or chafing of components.

Prior to taking the trailer on the road, inspect the tires for proper inflation and adequate tread; check all lights to make sure they are operating; ensure the hitch is free moving and well lubricated; make sure the vehicle attachment is rated for the weight of the trailer; check the vehicle and trailer brake operation.

When using a trailer, there are other precautions to note. First, avoid towing with too much or too little tongue weight as this causes the trailer to fishtail at certain speeds, and it may become uncontrollable. Second, take care when unloading the PPC to avoid damage.

## **Where to Fly**

The powered parachute can be transported by trailer from one flying field to the next. For as many benefits as this provides, transporting the powered parachute into unfamiliar territory also includes some safety and operational issues.

Make contact with the airport management to inquire about any special arrangements that may need to be made prior to departing from an unfamiliar airport. Check the Airport/Facility Directory (A/FD) for traffic pattern information, no fly zones surrounding the airport, and special accommodations that may need to be arranged.

Title 14 of the Code of Federal Regulations (14 CFR) part 91 states that powered parachutes are to avoid the flow of all other air traffic. In addition, you should inform local pilots about some of the incidentals of powered parachute flight (such as flying low and slow); the more information that other category pilots know about PPC flight characteristics, the more they will understand the specific needs of the powered parachute in flight. Sharing the same airspace with various aircraft categories requires pilots to know and understand the rules, and understand the flight characteristics and performance limitations of the different aircraft.

The ideal departure area for a powered parachute is an open grassy area clear of debris and obstacles with a groomed, even surface. Concrete and asphalt surfaces should be avoided, as well as lit runways, as the structural integrity of the wing and suspension lines may be compromised during takeoffs and landings if the wing catches on the runway surface or surrounding lighting.

Powered parachutes do not normally take off where the rest of the airport traffic takes off. This is to help both the PPC pilot and the pilots of other aircraft. A powered parachute requires time to set up and depart; it is not polite or safe to tie up an active runway while this is being done. Exceptions to this would be the edge of a very wide runway or an undeveloped area next to the active runway where setup can take place well away from the centerline of that active runway.

Another reason PPC pilots typically don't use standard runways is that you want to set up into the wind to avoid a crosswind takeoff. While slight crosswind takeoffs are possible, they are usually unnecessary due to the short-field capabilities of a powered parachute. You should do your best to point the machine into the wind before you lay out the wing.

Extend consideration to land owners that may own a flight strip in their field. You need permission to use private property as an airstrip. Locate the area on an aeronautical sectional chart to check for possible airspace violations or unusual hazards that could arise by not knowing the terrain or location. Avoid loitering around residential structures and animal enclosures because of the slow flight attributes of the powered parachute and the distinct engine noise.

While selecting a takeoff position, make certain the approach and takeoff paths are clear of other aircraft, or will be clear by the time the equipment is set up. Fences, power lines, trees, buildings, and other obstacles should not be in the immediate flightpath unless you are certain you will be able to safely take off and clear them during takeoff and climbout.

Walk the entire length of the intended takeoff and landing area prior to departure. Look for holes, muddy spots, rocks, dips in the terrain, high grass, and other objects that can cause the aircraft to be damaged or the wing to snag during takeoff and landing. Physically mark areas of concern with paint, flags, or cones; a pothole may not look like a pothole from the air.

There are a number of preflight actions you must perform, mandated by 14 CFR part 91. You must become familiar with all available information concerning your flight, to include runway lengths at airport of intended use, takeoff and landing distance accounting for airport elevation and runway slope, aircraft gross weight, wind, and temperature. For a flight not in the vicinity of a conventional airport, this information must include weather reports and forecasts, fuel requirements, and alternatives available if the planned flight cannot be completed.

## Weather

The weather is a determining factor for all flight operations. Get a full weather briefing prior to your flight, to include the current conditions and forecasts for your departure and destination areas, and along the route of flight. There are many sources for obtaining a weather briefing, such as [www.nws.noaa.gov](http://www.nws.noaa.gov), calling 1-800-WX-BRIEF, and a variety of internet sites that specialize in local and regional weather. Crosswind landings are possible in a powered parachute, but crosswind takeoffs should be avoided. It is important to review your departure procedure at your destination to ensure you don't get into a field you cannot depart from. In gathering your weather information, know the wind conditions, temperature and dew point spread, sky condition, and visibility. Review Chapters 10 and 11 in the *Pilot's Handbook of Aeronautical Knowledge* for a comprehensive understanding of weather theory, reports, forecasts, and charts.

PPCs fly best in calm air. Check the wind forecast as well as current conditions, as this information will determine whether safe flight can be conducted. Winds less than 10 miles per hour (MPH) are ideal; follow the recommendations provided by the PPC manufacturer for the aircraft you will be flying. Steady winds that are not gusting are more desirable, as the inflation and overall performance of the wing is more predictable. For example, 5 MPH with no gusting is better than 1 MPH gusting to 5 MPH. Some types of wings perform differently in certain types of wind conditions and pilotage skills—know your wing and your abilities. Crosswind takeoffs in a powered parachute are dangerous and should be avoided. If the runway configuration does not allow for takeoff into the wind, then the flight should be canceled or postponed from that takeoff area. Do not attempt to take off in a crosswind with a powered parachute unless it is within the pilot and aircraft capabilities, not a limitation in the aircraft POH, and you have been trained thoroughly for this advanced procedure. Crosswind landings are possible in a powered parachute, but crosswind takeoffs should be avoided. It is important to review your departure procedure at your destination to ensure you don't get into a field you cannot depart from.

Air temperature and humidity directly affect the performance of the powered parachute wing and engine. The powered parachute pilot who doesn't understand and respect the effect(s) density altitude has on any given flight may get into situations that are not desirable and could be hazardous. The higher the temperature, humidity, and the actual altitude of the field

you are operating from, the greater the role density altitude plays in determining how much runway the powered parachute needs to get off the ground with the load on board, and how much climb performance the wing will have once airborne. The powered parachute may have cleared that obstacle at 8 a.m. when the weather conditions were cooler with less humidity, but at 1 p.m. with increased air temperature and higher humidity levels the pilot will have to re-evaluate the performance of that same aircraft. You need a full understanding of density altitude to be a safe PPC pilot; refer to Chapter 9 in the *Pilot's Handbook of Aeronautical Knowledge*.

Understand the different cloud formations and the ground/air effects they can produce. [Figure 5-2] Cloud clearance and visibility should be maintained for the operations you intend to conduct (see Chapter 8 for cloud clearance requirements in each class of airspace). Knowledge of thermals and turbulence, and how to determine where they can occur is also important. [Figure 5-3]

Do not fly when ground and flight visibility is below minimums for your pilot certificate and the class of airspace where you will be operating (see Chapter 8). Be particularly watchful for low visibilities when the air and dewpoint temperatures are within a spread of three or four degrees. The closer these temperatures are to each other, the greater the chance for fog and reduced visibility conditions.

In addition to adhering to the regulations and manufacturer recommendations for weather conditions, it's important for you to develop your own set of personal minimums. These minimums will evolve as you gain experience, and are also dependent on your recency and currency in the make/model of aircraft you will be flying.

## Weight and Loading

Weight and loading must be considered before each flight. Do not exceed the maximum gross weight as specified in the POH. Always follow the POH performance limitations.

The balance of the pilot, passenger, fuel and baggage must be compared to the limitations, and the wing attachment to the fuselage position must be within the limits as specified in the POH. The cart must be balanced properly or an unsafe cart configuration, either nose-high or nose-low will result.

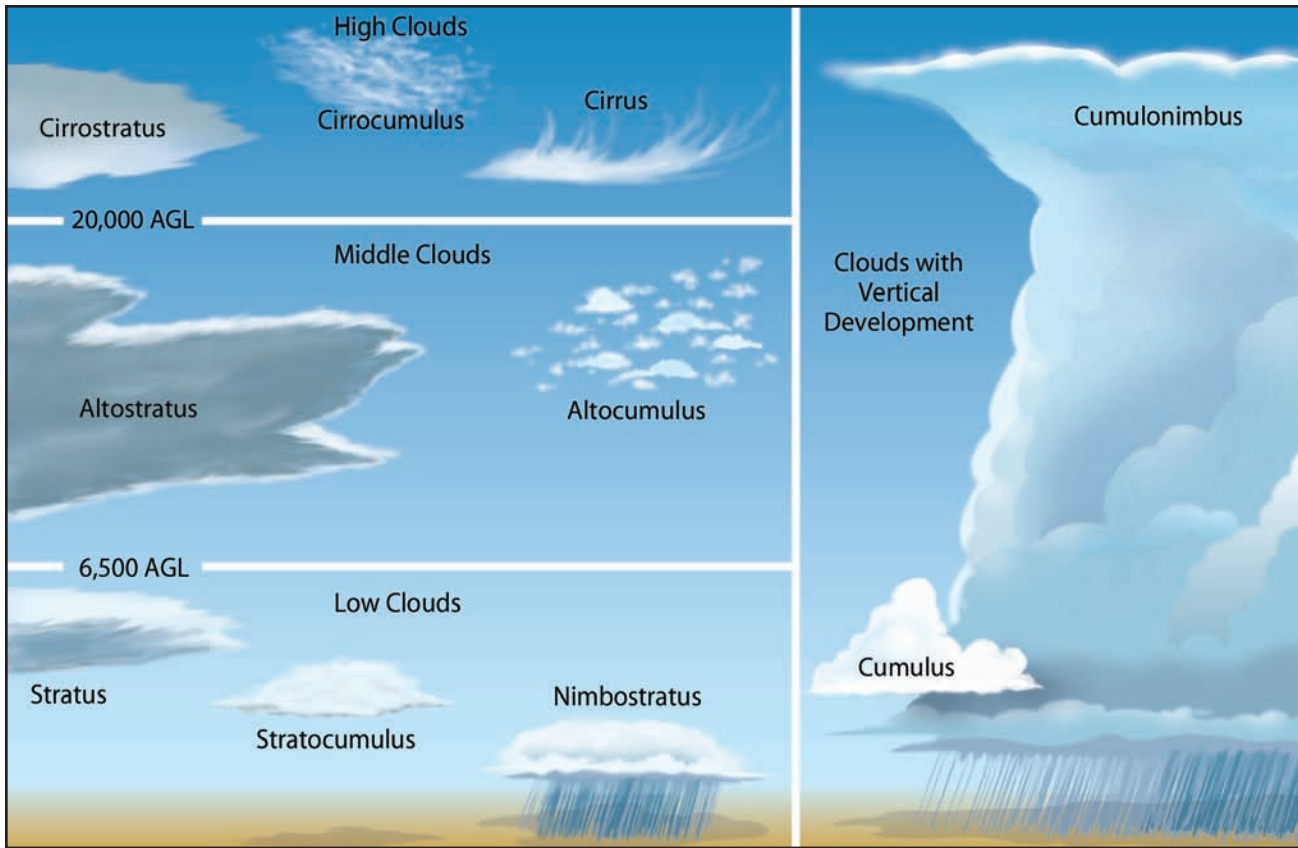

Figure 5-2. Basic cloud types.

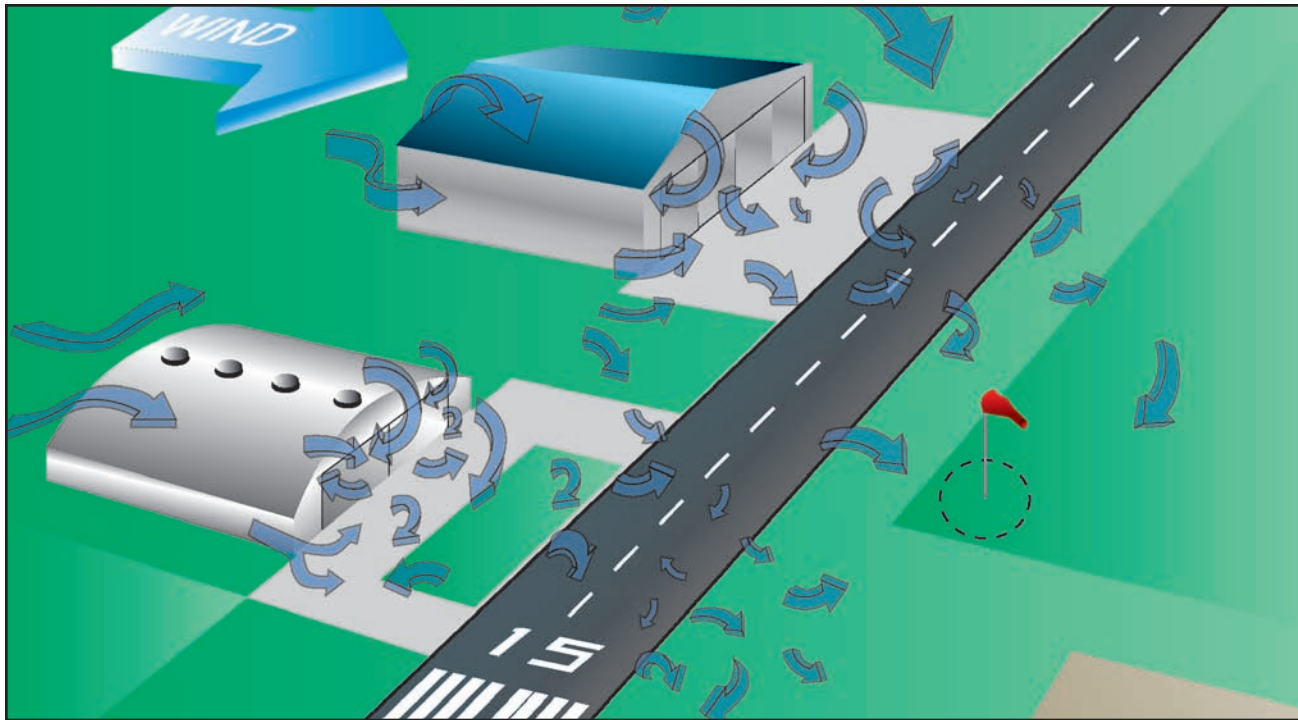

Figure 5-3. Turbulence encountered over manmade items and in nature.

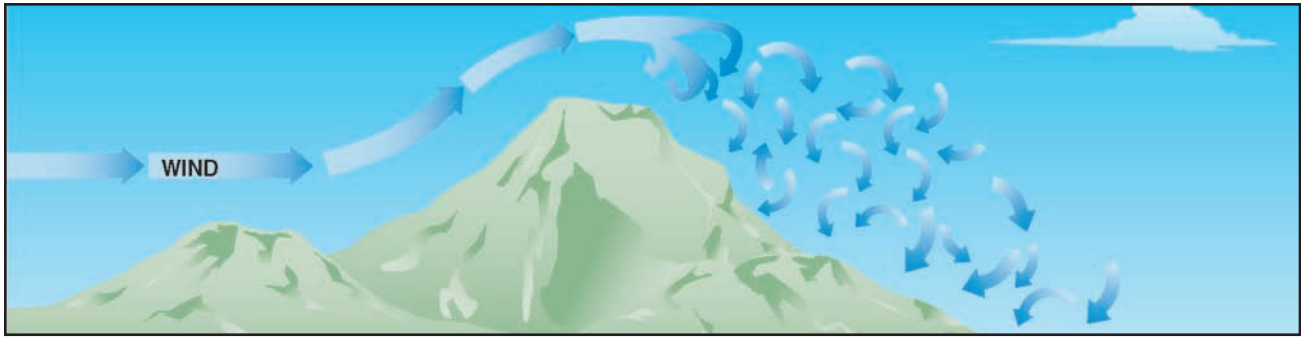

Figure 5-3 continued. Turbulence encountered over manmade items and in nature.

## The Preflight Checklist

Use a written checklist during preflight and ground operations. The checklist is an aid to the memory and helps to ensure that critical items necessary for the safe operation of the aircraft are not overlooked or forgotten.

## Certificates and Documents

The airworthiness of the powered parachute is determined, in part, by the following certificates and documents, which must be on board the aircraft when operated:

- Airworthiness certificate.
- Registration certificate.
- Operating limitations, which may be in the form of an FAA-approved Aircraft Flight Manual and/or Pilot's Operating Handbook (AFM/POH), placards, instrument markings, or any combination thereof.
- Weight and balance

AROW is the acronym commonly used to remember these items. The pilot in command is ultimately responsible to make sure the proper documentation is on board. [Figure 5-4]

Aircraft logbooks are not required to be on board the powered parachute when it is operated. However, you should inspect the aircraft logbooks prior to flight to confirm the PPC has had all required tests and inspections. The owner/operator must keep maintenance records for the airframe and powerplant.

At a minimum, there must be an annual inspection within the preceding 12-calendar months. In addition, the powered parachute may also need a 100-hour inspection in accordance with 14 CFR part 91 if it is used for hire (for example, for training operations). If a transponder or a transponder/encoder with a pitot-

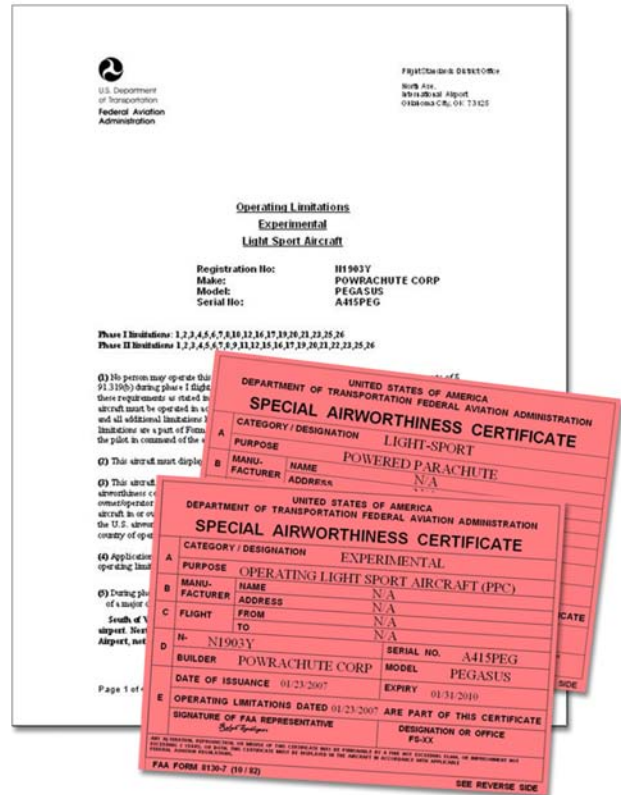

Figure 5-4. Required documentation must be carried on the aircraft at all times.

static system is used, it must be inspected within each preceding 24-calendar months.

The pilot must have in his or her possession a valid U.S. driver's license, or a valid medical certificate accompanied by a photo identification and pilot certificate. Sport pilots must also carry a copy of the endorsements issued from their logbook indicating they are qualified for the powered parachute category/class for the aircraft they are flying. The wing shape (rectangular or elliptical) and the landing system (land or sea) will be specified in this endorsement.



## Visual Inspection

The accomplishment of a safe flight begins with a careful visual inspection, regardless of the category/class of aircraft you will be flying. The purpose of the routine preflight inspection is twofold: to determine the powered parachute is legally airworthy, and that it is in condition for safe flight. You determine whether the PPC is in a condition for safe flight by a thorough and systematic preflight inspection of the aircraft and its components. The preflight inspection should be performed in accordance with a printed checklist provided by the powered parachute manufacturer for the specific make and model of aircraft. However, the following general areas are applicable to all powered parachutes.

The preflight inspection should begin as soon as you approach the aircraft. Since the powered parachute can be transported by trailer, the unloading of the aircraft allows you extra opportunity to look the cart over from front to back and top to bottom. First and foremost, you need to look for any damage that may have occurred during transit. Make note of the general appearance of the aircraft, looking for obvious discrepancies such as tires with low air pressure, structural distortion, wear points, cart damage, and dripping fuel or oil leaks. All tie-downs, control locks, and chocks should be removed during the unloading process.

It is absolutely necessary you are thoroughly familiar with the locations and functions of the aircraft systems, switches, and controls. Use the preflight inspection as an orientation when operating a make/model for the first time.

The actual “walk around” is a routine preflight inspection and has been used for years from the smallest general aviation airplane to the largest commercial jet. The walk around is thorough and systematic, and should be done the same way each and every time an aircraft will be flown. In addition to “seeing” what you’re looking at, it requires you take the appropriate action whenever a discrepancy is discovered. A powered parachute walk around will cover five main tasks:

1. Cart inspection
2. Powerplant inspection
3. Equipment check
4. Engine warm-up and check
5. Wing and suspension line inspection

Each PPC should have a specific routine preflight inspection checklist, but the following can be used as a guideline for most PPCs.

## Cart Inspection

Check the front nosewheel for proper play, tire inflation, and secure axle bolt. Test the ground steering bar connection points and ensure there is smooth steering range of motion from the steering bar. Check and secure the connections between the front fork and the front axle and the front fork and the gooseneck. [Figure 5-5]



**Figure 5-5. Check for proper tire inflation and that the axle bolt is secure.**

When brakes are installed, it is common for them to be on the front nosewheel. Typically, they are drum or disk style operated by a cable; it is important to inspect the cable lock, assuring it is tight. The brakes may be hydraulic disk brakes that also incorporate a cable; in this case, inspect both components. Check brakes and brake systems for rust and corrosion, loose nuts/bolts, alignment, brake pad wear/cracks, signs of hydraulic fluid leakage, and hydraulic line security/abrasion.

Inside the cart where the pilot sits, check the seats, seat rails, and seat belt attachment points for wear, cracks, and serviceability. A few manufacturers offer powered parachutes with adjustable front seats. The lever moves the pin in and out of the seat rail holes and the seat then moves forward and back along the rail. The seat rail holes should be checked for wear; they should be round and not oval so there is no play

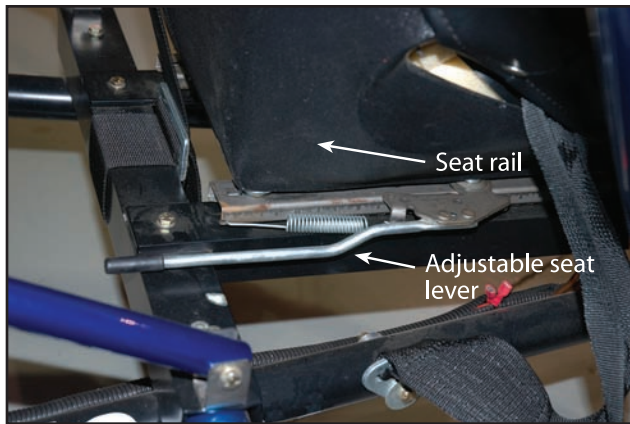

**Figure 5-6. Adjustable powered parachute front seat mechanism.**

in the fixed position of the pilot seat. Inspect where the seat lock pins fit; check the pin and seat rail grips for wear and serviceability. [Figure 5-6]

The battery and ignition switches need to be in the OFF position at the beginning of the preflight inspection. They will be turned on and then off again to check the different components operated by the power source during the preflight. While checking the ignition switches, check that the strobe is operational if one is installed. Exercise the primer or primer bulb, if the PPC is so equipped; you should feel resistance when exercised. Faulty primers can interfere with proper engine operation.

Manipulate the engine throttle control by slowly moving through its full range of motion to check for binding or stiffness. On two-stroke engines with oil injection, it is important to check that the oil injection mechanism is moving freely. [Figure 5-7]

Set the altimeter to the field elevation or set in the barometric pressure, if equipped. Turn on the ignition or engine instrument system master and make note of the fuel quantity gauge indications, if applicable, for comparison with an actual visual inspection of the fuel tank(s) during the exterior inspection.

Inspect for any signs of deterioration, distortion, and loose or missing bolts or locknuts. *Gently* shake the cart to determine if objects and airframe parts are loose and need to be tightened. Treat all aircraft and their components with respect and care while conducting a preflight. As with all aircraft, the PPC does not need to be “over-handled” to perform an adequate preflight inspection. Check that all cables are free of kinks, frays, abrasions or broken strands; check each end of each flying cable for bolt security and check that the thimbles are not twisted or elongated.

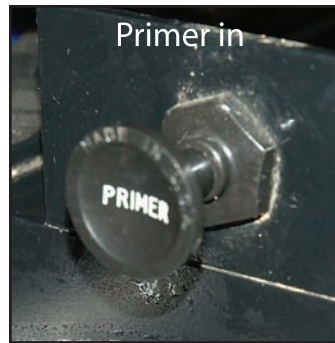

**Figure 5-7. Check the ignition switches, primer and oil injections mechanism during preflight inspections.**

Check the steering bars for freedom of movement, for proper steering line attachments, and confirm the steering bars are securely attached.

Inspect the rear wheel and axle assembly. Check the tires for proper inflation, as well as cuts, bruises, wear, bulges, imbedded foreign objects, and deterioration. As a general rule, tires with cord showing, and those with cracked sidewalls are unairworthy. Check the axle and axle hardware, and inspect that the wheels rotate properly.

## Fuel and Oil

Pay particular attention to the fuel quantity, type, grade, and quality. Many fuel tanks are sensitive to attitude when attempting to fuel for maximum capacity. The powered parachute attitude can also be affected laterally by a ramp that slopes. Always confirm the fuel quantity indicated on the fuel gauge(s) by visually inspecting the level of the fuel tank(s).

The engine manufacturer recommends the type of fuel that any given powered parachute engine should burn; this recommendation should be strictly conformed to. Although most PPC engine manufacturers recommend premium grade auto fuel, it is usually acceptable to burn 100LL AVGAS on a limited basis. Most airports will not have auto fuel available on the field.

Ensure the fuel caps have been securely replaced following each fueling and the vents are free and open. Most powered parachutes have an inline fuel filter located somewhere between the tank and the carburetors; check the fuel filter for contaminants. [Figure 5-8]

The fuel tank vent is an important part of all preflight inspections. [Figure 5-9] Be alert for any signs of vent

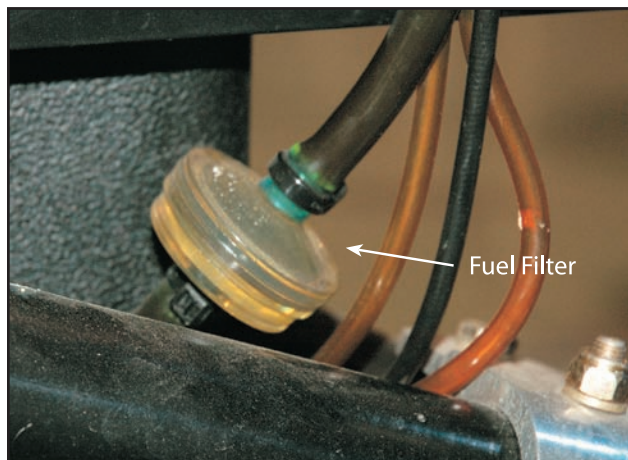

**Figure 5-8. Inspect the inline fuel filter during preflight.**

tubing damage, as well as vent blockage. A functional check of the fuel vent system can be done simply by opening the fuel cap. If there is a rush of air when the fuel tank cap is opened, there could be a serious problem with the vent system.



**Figure 5-9. Inspect that the fuel tank vents are free of dirt and debris to prevent fuel starvation during flight.**

Check the oil reservoir to ensure the proper oil is used. Check the oil level during each preflight and after each refueling. [Figure 5-10] If the consumption of oil steadily increases or suddenly changes, qualified maintenance personnel should investigate. After checking or adding oil to the PPC, ensure that the oil cap has been securely replaced. The oil reservoir on a two-stroke must be checked for adequate venting; if this becomes plugged, it could cause starvation of the oil to the engine.

Two cycle engines without oil injection premix the oil with the fuel. Assure the mixture ratio is correct. Proper mixing techniques is covered in the fuel section.

## Powerplant Inspection

Inspect the propeller for any signs of propeller blade chafing, and defects such as cracking. Check the propeller for large nicks in the leading edge, cracks, pitting, corrosion, and security. All propeller tape should be securely attached to the propeller surface, paying special attention to the convex side of the propeller for any delaminating; propeller tape is used primarily for protection on the leading edge of the propeller as well as a supplemental balancing device. Check the propeller hub for security, bolt threads showing and general condition.



**Figure 5-10. It is important to check the oil reservoir cap to make sure the vent holes are open and free of debris.**

Powered parachute engines are set up in a pusher configuration, so it is essential to check the engine area for loose items to ensure nothing is blown through the propeller, possibly injuring the aircraft, observers, or property. Carburetor(s) must be checked to make sure they are secure; check the air filter for condition and secure fit. Check the rubber manifolds for cracks and check spark plugs to make sure all of the spark plug caps are secure. On some two-stroke engines, there is a reservoir that contains the lubricant for the rotary valve; check this level on every preflight. Check gear reduction boxes for leaking seals and make sure there is not play within the gears. Look for signs of fuel dye which may indicate a fuel leak and deterioration of fuel lines. Check for oil leaks, deterioration of oil lines, and make certain that the oil cap, filter, oil cooler and drain plug are secure.

Check the exhaust system for white stains caused by exhaust leaks at the cylinder head or cracks in

the stacks. Check exhaust components for freedom of movement; they must be secure with all exhaust springs in place.

On liquid cooled engines, the radiator fluid level, as well as the overflow reservoir, must be checked and filled as necessary.

Check all visible wires and lines for security and condition.

## Engine Starting

Prior to starting the engine it is imperative to precisely follow the engine manufacturer's recommendation for engine warm-up. Follow the before engine starting and engine starting checklist procedures in the POH. Certain precautions apply to all powered parachutes.

Do not start the engine with the back of the cart of the powered parachute pointed toward an open hangar door, parked automobiles, or a group of bystanders. This is not only discourteous, but may result in personal injury and damage to the property of others as propeller blast is surprisingly powerful.

When ready to start the engine, look in all directions to be sure nothing is or will be in the vicinity of the propeller. This includes nearby persons and aircraft that could be struck by the propeller blast or the debris it might pick up from the ground. Turn on the anti-collision strobe prior to engine start (if so equipped), even during daylight operations.

First look around, and then shout "CLEAR PROP." Wait for a response from persons who may be nearby before activating the starter.

When activating the starter, keep one hand on the throttle. The other hand should be on the ignition in case the engine races immediately after start and the throttle has no effect. This allows prompt response if the engine falters during starting, and allows you to rapidly retard the throttle if revolutions per minute (RPM) are excessive after starting. A low RPM setting is recommended immediately following engine start. Do not allow the RPM to race immediately after start, as there will be insufficient lubrication until the oil pressure rises. In freezing temperatures, the engine will also be exposed to potential mechanical distress until it warms and normal internal operating clearances are assumed.

As soon as the engine is operating smoothly, check the oil pressure, if applicable. If it does not rise to the

manufacturer's specified value, the engine may not be receiving proper lubrication and should be shut down immediately to prevent serious damage. Although quite rare, the starter motor may remain on and engaged after the engine starts. This can be detected by a continuous very high current draw on the ammeter. Some powered parachutes also have a starter engaged warning light specifically for this purpose. The engine should be shut down immediately should this occur.

Starters are small electric motors designed to draw large amounts of current for short periods of cranking. Should the engine fail to start readily, avoid continuous starter operation for periods longer than 30 seconds without a cool down period of at least 30 seconds to a minute (some POHs specify even longer). Their service life is drastically shortened from high heat through overuse.

If the engine fails to start at all, it may be necessary to charge the battery or use the back-up pull starter. Hand propping is not a procedure typically used on powered parachutes. Always follow the manufacturers' recommendations while troubleshooting and follow those specific procedures.

## Engine Warm-Up

Engine warm-up, or run-up, not only brings the engine up to proper operating temperatures but also allows you to determine that the engine and its components are operating properly.

Generally, the engine start-up will follow these steps:

- Walk-around is complete.
- Safety check to include: front wheels properly braced, engine and propeller area clear of loose and foreign objects, area behind the cart is clear of debris, wing lines are away from the propeller.
- Prime the fuel system (as equipped).
- Activate strobe light if switch is independent of magneto switch.
- Shout "CLEAR PROP" and wait for "CLEAR" response from bystanders.
- Turn magnetos on.
- Engine gauge switch on.
- Check throttle – at idle.
- Start engine.

The warm-up procedure should never be skipped, as the result can be costly in engine repairs and detrimental to the physical well-being of the pilot and passenger. Pilots should know their engine temperature

parameters from the markings on the panel and the POH limitations. Once the engine has been brought up to normal operating temperatures, check that the engine will produce sufficient RPM. Once again, refer to the engine manufacturer's manuals for recommended procedures and parameters.

Continually monitor all the engine's temperature gauges and know the engine operational minimum, normal, and maximum temperature ranges. The engine manual will also specify "difference" temperatures between cylinders. Excessive split differences between cylinders should not be overlooked, even if both temperature readings are within the acceptable ranges for the engine. Do not fly the powered parachute if the temperature readings are not normal! Figure out what the problem is before it results in a dangerous situation or costly engine repair. Finally, test the ignition switches if the engine has dual ignition systems installed. By turning one switch off and checking the RPM and then alternating the check with the other switch, you can assure that both ignition switches are operational. An engine with a dual ignition system is intended to be run with both systems operating.

## Taxiing

You taxi the aircraft to get the cart from one place to another. The wing bag is typically hung from the cart or placed on the rear seat unless there are extra bars installed specifically to accommodate the wing bag while taxiing; check with your manufacturer for the recommended procedure. [Figure 5-11] You can taxi with the wing packed or with the wing inflated above you; it is called "kiting" if it is inflated. During all ground operations it is important to keep your hand on the throttle and your feet on the steering bars. Do not dangle your feet off of the steering bars as this could result in a broken ankle, foot, or leg. Do not use your feet to stop the PPC, even from low speeds. Wind is not a factor when taxiing with the wing in the bag; follow the procedures for initial takeoff if taxiing with the wing inflated, or "kiting," in any wind.

Be aware of other aircraft that are taking off, landing or taxiing and provide consideration for the right-of-way of others. Keep a lookout in front of you and on both sides. Be aware of the entire area around the powered parachute to ensure the PPC will clear all obstructions and other aircraft. If at any time there is doubt about the clearance from an object, you should stop the powered parachute and verify clearance.



**Figure 5-11. Follow manufacturer recommendations for bag placement when taxiing.**

Even though you may not be using a standard runway, you may need to cross active runways or taxiways to get to the area designated for powered parachute operations. That means understanding radio communications and keeping your eyes and ears open. You probably have better visibility than a pilot in a typical airplane.

The primary requirements for safe taxiing are positive control of the aircraft at all times, the ability to recognize potential hazards in time to avoid them, and the ability to stop or turn where and when desired. While on the ground, the throttle directly controls your groundspeed. It is important not to taxi too fast, and be careful no one is in your prop blast. Going too fast can damage the frame or the suspension. The grass you taxi on could have holes and ditches, and damage the suspension. When taxiway centerline stripes are provided, they should be observed unless necessary to clear airplanes or obstructions.

Ground steering is accomplished by controlling the ground steering bar. The ground steering bar may in fact be a bar, handle, wheel, or lever; ground steering controls are as varied as the powered parachutes themselves. Operate the ground steering in a slow and deliberate manner, never jerky or erratic. Some ground steering bars are pushed forward to turn right and pulled back to turn left. Others are just the opposite. Consult the POH for each make and model of aircraft you fly to determine the safe and proper operation of the ground steering.

When taxiing, it is best to slow down before attempting a turn. Sharp, high-speed turns place undesirable side loads on the landing gear and may result in an uncontrollable swerve. If the wing is inflated, the cart will not follow the direction of the wing due to the

friction (via the wheels) with the ground. If the cart and the wing are not going in the same direction, you must prevent the wing from gaining enough lift (via cart groundspeed) to pull the cart over on its side. (See Chapter 12 for more details on pull-overs.) Adjust power or apply braking as necessary to control the taxi speed. More engine power may be required to start the powered parachute moving forward, or to start a turn, than is required to keep it moving in any given direction. When using additional power, retard the throttle immediately once the powered parachute begins moving, to prevent excessive acceleration.

When first beginning to taxi the PPC cart, if equipped with brakes, test them for proper operation as soon as the powered parachute is put in motion (typically with a hand control). Apply power to start the powered parachute moving forward slowly, and then retard the throttle and simultaneously apply pressure smoothly to the brakes.

To avoid overheating the brakes when taxiing, keep engine power to a minimum. Rather than continuously riding the brakes to control speed, it is better to apply brakes only occasionally. Other than sharp turns at low speed, the throttle should be at idle before the brakes are applied. It is a common error to taxi with a power setting that requires controlling taxi speed with the brakes. This is the aeronautical equivalent of driving an automobile with both the accelerator and brake pedals depressed at the same time.

When taxiing with an inflated wing (kiting), the ram-air wing will try to weathervane. The wing is designed to be self-centering; its strongest desire is to point into the wind.

Stop the powered parachute with the nosewheel straight ahead to relieve any side load on the nosewheel and to make it easier to start moving ahead.

At nontowered airports, you should announce your intentions on the common traffic advisory frequency (CTAF) assigned to that airport. When operating from an airport with an operating control tower, you must contact the appropriate controller for a clearance to taxi, and a takeoff clearance before taxiing onto the active runway.

After landing, taxiing with the parachute inflated requires you to coordinate movements between the rolling cart on the ground and the flying wing in the air. Cross-controlling by steering the cart one way while failing to steer the wing in the same direction creates

a dangerous situation that may end in a rollover. Common errors in taxiing with the wing inflated are:

- Failing to maintain enough forward speed to keep the wing inflated and flying overhead.
- Maintaining too much speed over the ground and thereby lifting the nosewheel off the ground; preventing the nosewheel from being able to control the direction of the cart.
- Not steering the wing along with the cart.
- Attempting to turn the cart too tight for the wing to be able to keep up.
- Failing to take wind into account.
- Attempting to taxi when winds are too high, change in direction, or are gusty.

## Wing Inspection

The powered parachute flight instructor will spend a great deal of time explaining the systems of the wing, the proper preflight, and the different methods of staging the wing for inflation by means of different layout techniques. The wing, and its performance, is critical to flight and safety; once again a thorough and systematic preflight procedure is essential.

Check the wind direction and manually point the cart directly into the wind. Many PPC pilots use a telescoping rod with a windsock or long strip of narrow rip-stop suspended from the top, displayed from their powered parachute trailer or vehicle to determine wind direction and wind speed. Some pilots prefer hand-held wind speed/direction devices. Most conventional airports have some sort of wind indicator (windsock, wind T, etc.) positioned in the segmented circle, as well as electronic weather indicators that accurately measure wind speed and direction at the field. Once the powered parachute engine starts it will be nearly

impossible for the pilot to determine the direction of the wind without the aid of a wind direction indicator. [Figure 5-12]

Remove the wing bag from its stored position on the airframe, either on the rear or pilot's seat, or hanging from the airframe itself. It is critical that the bag not be twisted, rotated or turned when removing it from its storage location, as doing so will twist and entangle the suspension lines. Another determining factor in keeping the suspension lines free from is how you packed the wing away the last time it was flown; the proper procedure for re-bagging the PPC wing will be covered at the end of this chapter.

It is critical for the powered parachute pilot to be able to recognize when the suspension lines are twisted and to know how to untwist them. Most wing bags are clearly marked with an emblem or other marking to identify one side of the bag from the other. Keeping the marked side of the wing bag always facing in the same direction (either facing the cart or facing away from the cart) is a helpful reference to determine if you have twisted the suspension lines while moving the wing into place, either on or behind the cart. The key is to be consistent and methodical in whatever procedure you use. Your flight instructor will offer input on a practical procedure. The height and physical strength of the pilot will also be a factor in determining the best position on the cart to store the wing bag.

Place the wing bag on the ground directly behind the airframe as far back as the riser and support lines will allow, keeping the wing bag in the same configuration that it was removed from the cart. You will have to pull both line sleeves that hold the suspension lines out of

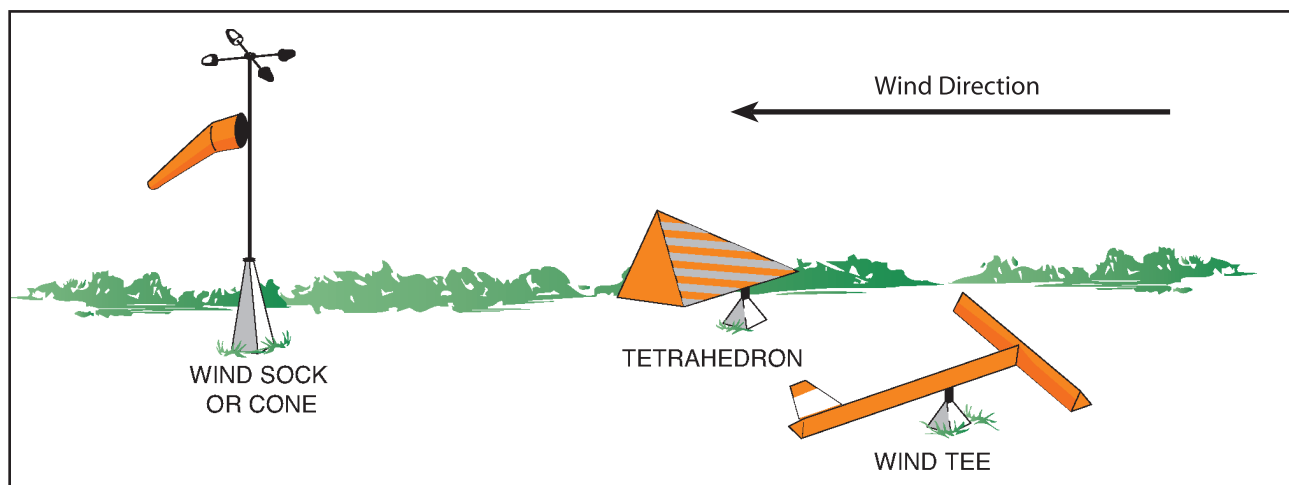

Figure 5-12. Wind direction indicators, used for positioning for takeoff.

the wing bag, and one line sleeve up and around the cart to follow the bag; those lines should run straight from the attach points on the cart to the wing bag after the bag is in position behind the cart. Tilt the wing bag toward the cart to spill the folded wing out of the bag and onto the ground. [Figure 5-13]

With the wing folded behind the cart, you are ready to spread it out and in doing so begin to visually inspect the uninflated wing. Unfold the right side of the wing toward the right and repeat on the left side. As you unfold the wing, it should remain centered directly behind the cart. After the wing is completely unfolded, stand directly behind the cart and hold the leading edge of the wing up in front of you as you face the backside of the cart. You will see an “x” in the lines; this “x” should be positioned directly behind the centerline of the prop on the cart. [Figure 5-14] If it is not, physically pick up the center and drag it into the center position. Then go to the end of the side that will be bunched up and pull out the slack.

Remove the protective sleeves that cover the suspension lines and their components. The protective sleeves are referred to as line sleeves and there is a line sleeve on each set of lines (or two — the right and the left). [Figure 5-15]

While laying out the wing, check for tears in the fabric, torn or loose stitching, abrasions, and deterioration of the fabric from ultraviolet rays. The sun is one of the powered parachute wing’s worst enemies, next to the prop! Certain colors deteriorate faster than others, like red and orange, when exposed to ultraviolet rays from the sun. When the wing is not being used, you should always return it to its wing bag. Take this opportunity to check the wing cells for debris, such as stones, sticks, and bugs; lifting the wing by the trailing edge and gently shaking it will allow most captured debris to fall out of the ram-air openings on the leading edge of the wing.

With the wing centered behind the cart, it is time to start checking the suspension lines. At first glance it may look difficult to sort out all of the lines from the cart to the wing. Most of the time, the lines will straighten out with just a light flick of the wrist. Make sure you have no twists or line-overs and your lines are straight. As long as the wing has not been physically removed, or disconnected from the cart, there should not be any permanent knots in the lines. In the event that you detect pressure knots during the line inspection they are easily removed with minimal manipulation.



**Figure 5-13. Wing removed from wing bag and folded behind the cart.**



**Figure 5-14. “X” in the suspension lines marks the exact center of the uninflated wing.**



**Figure 5-15. Removal of the line sleeve is an important step in the wing layout and inspection.**

Small twigs, stems from weeds, and other debris can get caught in the lines to form pressure knots. Pressure knots are a concern because they are only “knots” when there is tension on the lines. That means they are only a problem when your wing is inflated. As soon as you land, the foreign object often shakes free and there is no knot. However, while you are flying, that



pressure knot can cause the powered parachute to go into a steep turn. Make sure there is nothing around to catch into your line sets. The more organized the suspension lines are laid out during this preflight check, the more likely that the wing will kite evenly and without mishap. It may take a great deal of space to get all the cells open during the inflation of the wing. Aborting the takeoff to re-kite the wing is always an option, but it is not desirable. Preflight the wing correctly the first time.

If you put your wing away correctly and took it out as described, it should not have any twists in it. However, you still need to check. Start where the risers attach to the cart. Make sure they are not twisted around anything and trace each one back to the point where the wing risers are attached to the cart.

Check the steering lines on both sides of the cart; make sure the anchor point knots are secure and the lines flow freely through all guides and pulleys. Make sure the links on both sides of the aircraft are secure; it is recommended that the links are finger tight plus one-quarter turn. Continue by checking that the riser cables are not twisted or damaged and they are free from tangles. At this time pull slack from the steering lines so the steering bars are fully retracted. Physically separating the steering lines from the suspension lines, pulling them out and away to the outer edge of the wingtips, enables you to visually see the steering lines are free from being tangled with the rest of the lines. [Figure 5-16]

Continue to check the suspension lines for tangles, knots and wear and the attachment points for security and lack of fraying. [Figure 5-17] The A lines should be visually and physically separated from the B lines at the point where the lines are connected to the risers. Most newer wing lines are color-coded to make this process visually easier; the older wing styles will still be separated and configured the same way as the newer wings, however all the lines will be the same color. The A lines will travel toward the leading edge of the wing and subdivide into the C lines. The B lines will travel toward the trailing edge of the wing and subdivide into the D lines. Make sure that the lines are all separated and not tangled. The A/C lines will be on top of the B/D lines when the lines are returned to the ground after the preflight of each section. Make sure there is no debris around to catch in the line sets during wing inflation; when the length of the line is altered it changes how the line holds the wing. The length of the lines are clearly defined by the manufacturers and should not be changed. The more organized



**Figure 5-16. The pilot will physically pull the steering lines out and away from the bundle of suspension lines to ensure they are tangle free.**

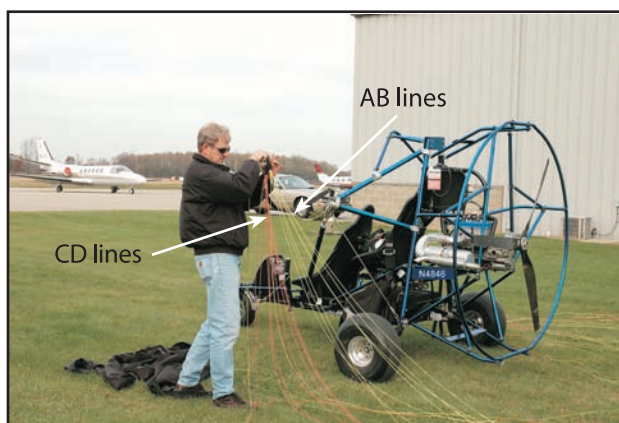

**Figure 5-17. Check the suspension lines for tangles, knots, and wear.**

the suspension lines are laid out during this preflight check, the more likely that the wing will kite evenly and without mishap; a lot of runway can be used up trying to get all the cells open during inflation of the wing. Aborting the takeoff to re-kite the wing is always an option, but it is not desirable. Preflight the wing correctly the first time; taking your time will pay off in the end.

## Line Tangles, Twists, and Line-Overs

Line tangles and twists can be frustrating if you do not understand how to solve them. The good news is that wing line problems are simple to understand, few in type, and easy to solve. They break down into line twists and line-overs. A definite advantage for the pilot is that both ends of the suspension lines are attached to either the risers or the wing. That means there are no loose ends to get twisted in and around each other. Any loops in the lines readily pull out if shaken a little; gently shaking all of the lines loose is

an important step to get the wing laid out properly in preparation for flight.

### Line Twists

A line twist is when all of the lines on both sides of the wing are spiraled together. Sometimes it will seem that all of the lines on one side are twisted around the steering line. That is actually the case. [Figure 5-18] Trying to fly the powered parachute with the suspension lines twisted is unsafe and the pilot should consider the wing unairworthy until the line twist is removed. Line twists most often occur because the pilot inadvertently flips, or turns, the wing over while moving it from the stowed position. This is why it is so important to put your wing away and take it out the same way each time. The suspension lines can also get twisted if the wing flies over the cart accidentally, or if the wing is incorrectly repositioned behind the cart when the wing settles to one side of the cart during an aborted takeoff or during landing.



**Figure 5-18. Line twist.**

Unless someone has mistakenly twisted a single set of suspension lines while rigging the PPC wing to the cart at the attachment points, a line twist will happen to both sets of lines on both sides of the powered parachute at the same time. This stands to reason if you think of the entire configuration of cart and attached wing as a continuous structure or a complete circle.

To get rid of a line twist, you do not have to pack the wing back into the wing bag and flip the whole bag in reverse, although this is an option. You can actually flip the wing while it is out of the bag.

With the wing laid out behind the cart, determine if the twist is clockwise or counterclockwise in configuration. If the twist in the line is traveling clockwise as you face the chute, the wing edge you are working with will have to travel counterclockwise back through the

center of the two sets of lines (or through the center of the circle created by the cart/wing configuration) and under the twisted group of lines you are holding. A counterclockwise twist will require just the opposite movement. The wing edge will need to travel clockwise under the line set and then up and over the twist via the center of the circle. Remember to maintain the clockwise motion for the counterclockwise twist, and the counterclockwise motion for the clockwise twist.

Disconnecting the wing from the risers or the wing from the cart is not a safe practice; the flight instructor needs to explain this to the PPC student in detail. The risers are specific to each cart. Refer to the PPC manufacturer and the operating manual for information.

Starting at the riser cables, gather all the lines in the group and walk toward the wing keeping the lines gathered as you go. Once close to the wing, you can easily manipulate the edge of the wing and not tangle the lines any further. The key is to remember that the lines are twisted as a group—not tangled individually—therefore they must be untwisted as a group to prevent them from becoming tangled. [Figures 5-19 and 5-20]



**Figure 5-19. Undoing a line twist—beginning of the process.**



**Figure 5-20. Pilot throwing the wing edge through to undo a line twist.**

Lay out the half of the wing you just worked on. If that side looks good, it means you can do the same thing to the other side of the chute. The same sequence of checking for twist direction, gathering the lines and then twisting the wing edge in the opposite direction of the twisted lines is completed on the second set of lines. It stands to reason that the twist will be in the opposite direction than the twist on the other set of lines you just cleared.

There is a possibility that the side you are working on still doesn't look right when you re-check it. If the lines still look twisted, then you probably flipped the wing the wrong way. The good news is that there are only the two types of line twists, clockwise and counterclockwise—with a little practice you will be able to recognize the twist well before you start handling the wing.

### Line-Overs

The line-over is one of the most dangerous things that can happen to the powered parachute wing. A line-over is exactly what it sounds like. Instead of the wing line going straight from the wing to the riser system, it takes a trip over the top of the wing first. This means that when the wing inflates, the suspension line that is over the top of the wing will pinch the wing together and prevent the proper inflation of the wing to produce the airfoil necessary to achieve flight. If a line is over the top surface of the wing, the pilot risks serious injury or death if takeoff is attempted. To recognize a line-over before you take off, look for a line that is twisted with other lines on one or both sides of the wing. If you see that, your next step should be to inspect the leading edge and top of the wing closely. If you see a line wrapped over the top, you have found your problem.

Sometimes using the “stacked” method of laying out the wing during the final wing staging before flight versus the “inverted” method can inadvertently produce a line-over on the top side of the wing as it inflates. Also, “stuffing” the wing into the wing bag versus methodically folding the wing for storage can cause a line to become wrapped around the top of the wing mistakenly. [Figure 5-21]

To correct a line-over, pull the fabric of the wing through the loop made by the line-over. To know which side to pull the noncompliant suspension line to, trace the line to its home line group (left or right riser) before you start pulling things around. Sometimes the side will be easy to determine because the line-over is either close to the left or right edge of the



**Figure 5-21. A simulated line-over.**

wing. When it is not, tracing it is the best way to save time and to determine the correct way to pull the wing fabric.

### Preparing for Takeoff

Wing inflation and kiting procedures are critical to a successful takeoff. Refer to Chapter 7 for information on how to lay out the wing, wing inflation, and kiting.

### After Landing

It is imperative to evaluate the field in which you intend to land, particularly because of the unique nature of the powered parachute wing, and what happens to it prior to landing. If the field is being used by other aircraft, taxi the powered parachute off the “active” area or runway surface while the wing remains kited. Ground taxiing with the wing kited takes a little practice, but the flight instructor will make sure the student pilot has adequately mastered this skill prior to takeoff instruction.

After the powered parachute has touched down, **release the flare on the wing**; this is done to prevent the aircraft from becoming airborne again. Not releasing the flare on landing is a critical and common mistake made by both new and seasoned PPC pilots. With the throttle at idle, the powered parachute begins to slow down to the point where the stream of air is not sufficient to maintain the wing's pressurization. At this time, the engine must be shut down immediately; the consequences of not turning off the magnetos during the after-landing roll are detrimental to the well-being of the wing because the propeller will most likely chop the PPC lines. A turning propeller and the

wing and its components do not mix. Once you turn off the magnetos, you will physically grab the steering lines from overhead and pull the wing to the ground to finish the deflation process. If the wing is allowed to “float” down on its own, a small gust of wind can force the suspension lines onto hot exhaust surfaces which can melt the lines, or even pick up the cart and instigate a landing roll.

## Clearing the Runway

If a powered parachute lands on the center of a runway, it is considered good practice to taxi to the edge of or even off of the runway before collapsing the wing and stowing equipment. When doing that, it is important to keep the powered parachute moving after landing to keep the wing inflated. The safest and easiest method is to keep taxiing straight into the wind until you clear the runway or landing area and can collapse the parachute out of the way of other aircraft. If you determine that winds are too strong or gusty to taxi off of an active runway, an alternate landing area should be chosen.

## Parking

Unless parking in a designated, supervised area, you should select a location which will prevent the propeller blast of other airplanes from striking the powered parachute broadside. The powered parachute engine is not enclosed in a cowling and engine surfaces will be extremely hot. Never assume a bystander will know this; even though the engine is not operating, it can still be dangerous.

Once out of the powered parachute, you should immediately pull the trailing edge of the wing forward toward the cart and roll the leading edge and cell openings under the wing surface; this will prevent gusts of air from grabbing the wing and pulling the cart backward. After the wing is totally disabled from becoming airborne, you can assist your passenger in disembarking from the cart.

## Postflight

A flight is never complete until the engine is shut down and the aircraft is secure. A pilot should consider this an essential part of any flight.

After engine shutdown and the passenger exits the cart, the pilot should accomplish a postflight inspection. This includes checking the general condition of the aircraft. For additional departures, the oil should be rechecked and fuel added if required. If the PPC is

going to be inactive for a period of time, put the wing properly back in the bag to keep it out of the sun.

## Packing the Wing

As discussed earlier in this chapter, packing the wing back into the wing bag at the end of the flight is a necessary task. The care and method the pilot employs for this critical task directly affects whether or not the wing is easy to unpack for the next flight. The process of folding the wing and returning it safely to its wing bag takes little time and the powered parachute passenger can lend a hand to the pilot in the process. If the pilot is flying solo the process will take a little longer, but the overall results will be the same and this gives the pilot an opportunity to do a thorough postflight inspection of both the wing itself and the suspension lines.

After disembarking from the cart, the wing should be repositioned in the inverted layout with the exception that the cart/prop hoop will be positioned very close to the trailing edge of the wing. At that time the line sleeves should both be replaced on each set of suspension lines. When the line sleeves are in place, the two bundles and any suspension lines left showing are placed on the exposed lower surface of the wing where they will be neatly packaged for storage during the folding process of the wing.

Starting with one outer trailing edge of the wing, draw the wing surface up and over the surface of the wing fabric to the very center of the wing. The same action will then be completed on the leading edge of the wing on the same side. The process is then completed two more times on the same side. Then the wing is folded from the other side three times in the same manner, resulting in a long rectangle of wing lying directly behind the prop line of the cart. This is one example; it is important for you to follow the manufacturer’s recommendations for your PPC.

The pilot then starts at the edge closest to the cart and folds the sides of the folded wing alternately in on each other, depressing the trapped air out of the fabric, all the way to the farthest area away from the cart. [Figure 5-22] Once this is complete, the wing package size is established by taking the farthest edge and folding it toward the cart over and over until a neat square is obtained on the last fold.

After the wing is folded and lying on the ground behind the cart, the wing bag is placed on the ground next to the wing (on the side away from the cart). [Figure 5-23] It is advised to have a “marked” side

of the bag and always keep the marked side facing up or in the same direction every time you load the wing into the bag and onto the cart. The wing is then neatly pulled into the bag. The pilot then picks the bag up on end and gathers the line sleeves on top of the wing. [Figure 5-24] Refer to the manufacturer's recommendations for loading the wing in its bag on the cart for taxi and storage.



**Figure 5-22. Squeeze out the air as you fold the wing for packing.**



**Figure 5-23. With the wing folded, you pull it into the bag.**



**Figure 5-24. The line sleeve on the side of the cart where the bag will be stored can be placed on top of the folded wing, inside the bag; the other line sleeve will be used to store the bag on the cart.**

# CHAPTER 6

## BASIC FLIGHT MANEUVERS

### The Four Fundamentals

There are four basic flight maneuvers upon which all flying tasks are based: straight-and-level flight, turns, climbs, and descents.

In addition, the powered parachute (PPC) has a unique characteristic, the pendulum effect, as covered in Chapter 2. This chapter will cover the basic flight maneuvers and how they are influenced by this pendulum effect.

### Flight Controls

The PPC has two basic flight controls:

1. Throttle: used to adjust the vertical speed to climb or descend
2. Steering controls: used to turn right or left

The wing design, angle of trim, and total weight determine the PPC airspeed, which remains about the same for most flight operations.

The vast majority of PPC steering is done via either foot pedals or foot steering bars. However, some PPC designs incorporate hand steering controls. In addition to the mechanical hand or foot steering controls, the steering line itself can be pulled directly or in combination with the mechanical controls. For simplicity of the information in this handbook, flight steering controls will be addressed as foot controls. For those PPCs with hand steering controls or steering lines that are pulled directly, substitute “push the foot steering control” with “pull the hand steering control” or “pull on the steering line.”

### Throttle

While in the air, the throttle provides thrust and therefore controls altitude; it is used to climb and descend. Throttle changes will not measurably affect your airspeed. The aircraft maintains about the same indicated airspeed throughout your pitch angle and altitude changes. There is less than a 1 MPH increase in speed as the throttle is increased from gliding flight to level

flight; not easily measured on the instruments or felt by the pilot in the air.

Pitch angle changes in a PPC are similar to pitch changes in an airplane being flown at a constant airspeed. Assuming a typical 3-to-1 glide ratio for a powered parachute, the pitch increases about 20 degrees from gliding flight to level flight. The pitch would increase an additional 20 degrees from level flight to full power climb, assuming a three-to-one climb path with a high powered engine. This total pitch change of 40 degrees from glide to high powered climb is significant and noticed by the pilot, passenger, and observers on the ground. Throughout the large pitch variations of the PPC, the PPC will continue to fly at about the same airspeed, even with the engine off.

As you descend with the throttle retarded, the nose of the cart is pointed more towards the ground while the wing is overhead. As you climb, the nose of the cart is pointed more towards the sky, and the wing appears to be rotated in back of you. These are large pitch changes. A common misunderstanding is that these pitch changes, which can be as much as 40 degrees, are a change of angle of attack. This is not the case. The angle of attack stays almost constant for the same weight and the same speed, but the pitch angle, especially as viewed from the cart, changes dramatically.

On a PPC, the angle of trim is determined by the suspension lines and set at the factory, but the cart can rotate around the riser attachment point to the cart. Generally, the angle between the cart and the wing remains the same; both pitch together rotating around the center of gravity of the complete aircraft. [Figure 6-1]

Flying in good atmospheric conditions and using smooth throttle applications can avoid additional loading which results in slight increases in angle of attack and speed.

A common, inappropriate use of the throttle is an abrupt power application when the engine is at idle. This abrupt application of throttle from idle to full

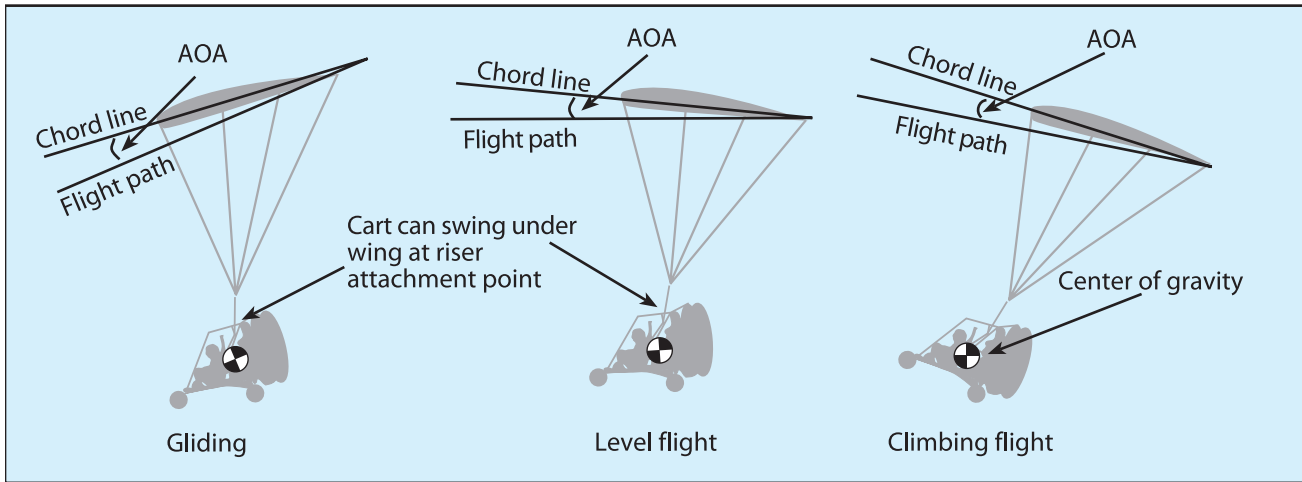

**Figure 6-1. The cart and wing pitch together.**

creates a porpoising effect. Gradually increase the throttle to full to avoid the abrupt porpoising.

### Clearing Turns

Pilots should perform clearing turns prior to beginning any maneuver and any turns. Proper clearing procedures combined with proper visual scanning techniques are the most effective strategy for collision avoidance. The essential idea of the clearing turn is to be certain that the next maneuver is not going to proceed into another aircraft's flightpath. Refer to Chapter 9.

### Turning the Powered Parachute

Steering lines run from the foot controls, through a series of pulleys parallel to the risers and suspension lines and are connected to the trailing edge of the corresponding side of the wing. The right steering line at the front end is attached to the right steering control at the cockpit (either foot or hand control), and the other end is directly attached to the trailing edge of the right side of the wing. Hence, when you push a foot steering control, you pull on a steering line and "pull-down" the trailing edge of the corresponding side of the wing, which creates drag on that side of the wing's trailing edge. The drag from the pulled-down trailing edge slows down and drops that side's wing, and the opposite side of the wing simultaneously pivots around the vertical and longitudinal axes in a coordinated turn. The PPC is designed to fly straight into the relative wind, which is a key factor in the PPC's ability to automatically perform a coordinated turn. [Figure 6-2]

While airborne, you will turn in the same direction of the foot steering control that you push: push right foot—go right; push left foot—go left.

Similar to the pendulum effect with throttle, there can also be a swinging pendulum effect during turns. For example, if you are in a stabilized right, medium-banked turn (approximately 20 to 45 degrees bank), the pendulum is swinging out opposing the lift component of the wing. If an abrupt left turn is initiated, the wing will start to turn but the momentum of the cart cannot respond as quickly. This results in the pilot not coordinating the pendulum effect, and can be avoided with smoother and less abrupt turns so the cart can keep up with the wing.

### Feel of the PPC

The ability to sense a flight condition, without relying on cockpit instrumentation, is often called "feel of the PPC," but senses in addition to "feel" are involved.

Sounds inherent to flight are an important sense in developing "feel." The air rushes past the PPC pilot, who is not typically masked by enclosures. When the level of sound increases, it indicates that speed is increasing. Also, the powerplant emits distinctive sound patterns in different conditions of flight as the RPM is adjusted. The sound of the engine in cruise flight may be different from that in a climb, and different again from that in a descent and can aid the pilot in estimating not only the present airspeed but the airspeed trend.

The sources of actual "feel" are important to the pilot. The pilot's own body responds to forces of acceleration. These "G" loads imposed on the cart are also felt by the pilot. Increased G loads force the pilot down

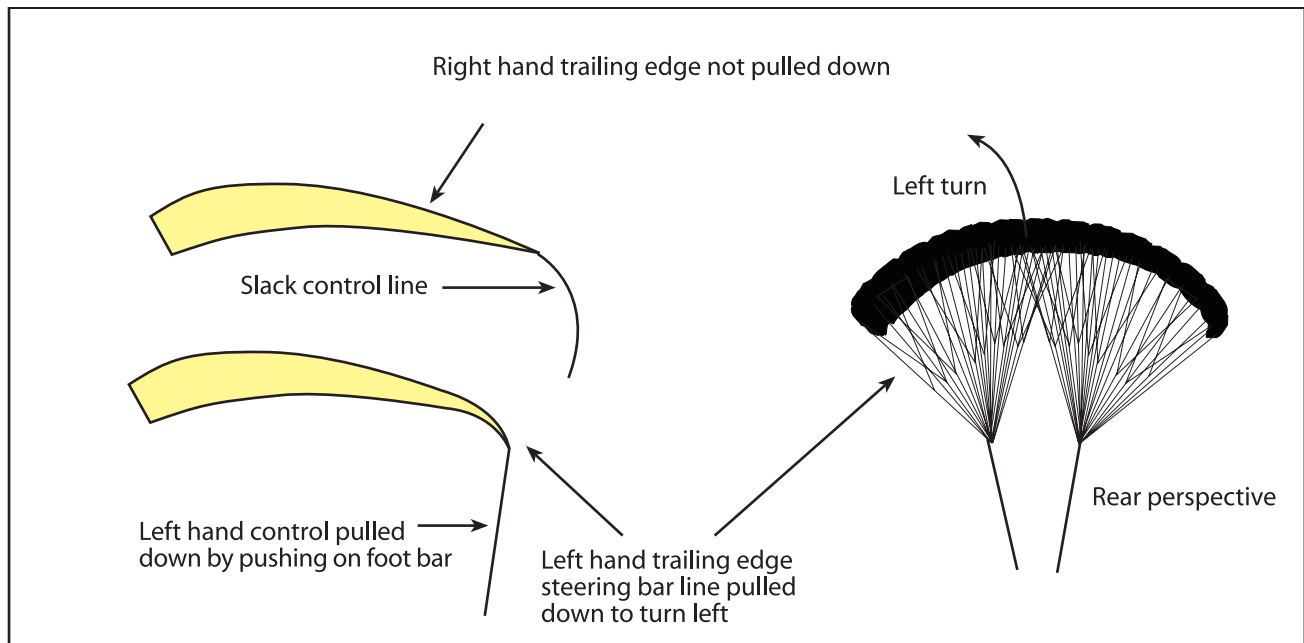

**Figure 6-2. Apply steering input to one side of the trailing edge to turn.**

into the seat or raise the pilot against the seat belt. Radial accelerations produce side loadings, which will shift the pilot from side to side in the seat. These forces need not be strong, only perceptible by the pilot to be useful.

An accomplished pilot who has excellent “feel” for the PPC will be able to understand and coordinate the rate of bank change so as not to overshoot the desired course or bank, and ultimately be able to anticipate the pendulum effect. The wing trailing edge control surfaces move in the airstream and meet resistance proportional to the speed and weight of the cart. When the cart is heavy and flying faster, the steering controls are stiffer and harder to move because the wing internal pressure is higher. When the cart is light and flying slower, there is less force required and controls move easier.

The senses that contribute to “feel” of the airplane are inherent in people. However, “feel” must be developed. The flight instructor should direct the beginning pilot to be attuned to these senses and teach an awareness of their meaning as it relates to various conditions of flight. To do this effectively, the flight instructor must fully understand the difference between perceiving something and merely noticing it. It is a well established fact that the pilot who develops a “feel” for the PPC early in flight training will have little difficulty with advanced flight maneuvers.

## Attitude Flying

In a PPC, flying by attitude means visually establishing the aircraft’s attitude with reference to the natural horizon. [Figure 6-3] Attitude is the angular difference measured between an aircraft’s axis and the line of the Earth’s horizon. Pitch attitude is the angle formed by the longitudinal axis of the aircraft and the horizon. Bank attitude is the angle formed by the lateral axis with the horizon.

In attitude flying, the PPC pilot controls two components: pitch and bank.

- Pitch control is the control of the PPC about the lateral axis by using the throttle to raise and lower the nose in relation to the natural horizon.
- Bank control is control of the PPC about the longitudinal axis by use of the PPC steering controls to attain a desired bank angle in relation to the natural horizon.

## Straight-and-Level Flight

It is impossible to emphasize too strongly the necessity for forming correct habits in flying straight and level. All other flight maneuvers are in essence a deviation from this fundamental flight maneuver. Perfection in straight-and-level flight will not come of itself. It is not uncommon to find a pilot whose basic flying ability consistently falls just short of minimum expected standards, and upon analyzing the reasons for the shortcomings to discover that the cause is the inability to properly fly straight and level.



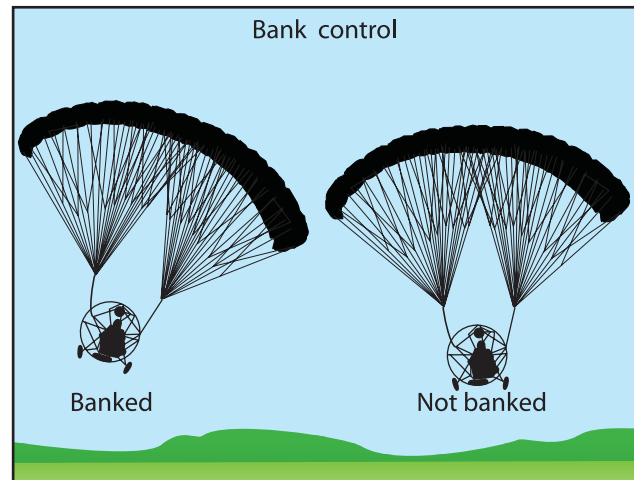
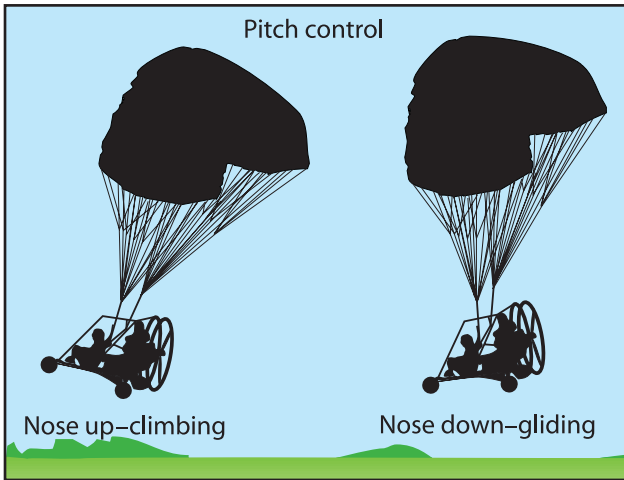

**Figure 6-3. PPC attitude is based on relative positions of the aircraft on the natural horizon.**

Straight-and-level flight is flight in which a constant heading and altitude are maintained. It is accomplished by making immediate and measured corrections for deviations in direction and altitude from unintentional slight turns, descents, and climbs. Level flight, at first, is a matter of consciously fixing the relationship of the position of some portion of the PPC, used as a reference point, with the horizon. In establishing the reference points, place the PPC in the desired position and select a reference point. No two pilots see this relationship exactly the same. The references will depend on where the pilot is sitting, the pilot's height (whether short or tall), and the pilot's manner of sitting. It is, therefore, important that during the fixing of this relationship, you sit in a normal manner; otherwise the points will not be the same when the normal position is resumed.

In learning to control the aircraft in level flight, it is important to use only slight control movements, just enough to produce the desired result. Pilots need to associate the apparent movement of the references with the forces which produce it. In this way, you can develop the ability to regulate the change desired in the aircraft's attitude by the amount and direction of forces applied to the controls.

The pitch attitude for level flight (constant altitude) is usually obtained by selecting some portion of the aircraft's nose as a reference point, and then keeping that point in a fixed position relative to the horizon. [Figure 6-4] Using the principles of attitude flying, that position should be cross-checked occasionally against the altimeter (if so equipped) to determine whether or not the pitch attitude is correct. If altitude is being gained or lost, the pitch attitude should be readjusted in relation to the horizon and then the altimeter rechecked to



**Figure 6-4. Nose reference for straight-and-level flight.**

determine if altitude is now being maintained. The application of increasing and decreasing throttle is used to control this attitude.

In all normal maneuvers, the term "increase the pitch attitude" implies raising the nose in relation to the horizon (by increasing power); the term "decreasing the pitch attitude" means lowering the nose (by decreas-

ing power). While foot controls do have an effect on altitude, they are not typically used as a control for flying straight and level. A PPC must be capable of maintaining altitude to tolerances using the controls as designed.

Anytime the wing is banked, even very slightly, the aircraft will turn. In a PPC the pilot has no useful reference to measure bank angle like an airplane or weight shift control aircraft where the wing tips are visible in relation to the horizon. The objective of straight-and-level flight is to detect small deviations from laterally level flight as soon as they occur, necessitating only small corrections. Reference to the magnetic compass or GPS, if so equipped, can be made to note any change in direction; however, the visual reference of a point on the horizon with a point on the aircraft such as the front wheel or instrument panel will typically be used for sport pilot training.

Continually observing the nose to align the heading should be avoided. The pilot must spend more time scanning for air traffic than focusing on heading. This helps divert the pilot's attention from the aircraft's nose, prevents a fixed stare, and automatically expands the pilot's area of vision by increasing the range necessary for the pilot's vision to cover.

Straight-and-level flight requires almost no application of control pressures if the aircraft is properly trimmed to fly straight and the air is smooth. Some PPCs will have a directional trim control which adjusts the tension in a control line to make it fly straight. Each PPC manufacturer has a unique design for their particular aircraft. The pilot must not form the habit of constantly moving the controls unnecessarily. You must learn to recognize when corrections are necessary, and then make a measured response. Tolerances necessary for passing the PPC practical test are  $\pm 10$  degrees heading and  $\pm 100$  feet altitude. Students may initially start to make corrections when tolerances are exceeded but should strive to initiate a correction before the tolerances are exceeded, such as starting correction before the tolerance is  $\pm 5$  degrees heading and  $\pm 50$  feet altitude.

Since the PPC does not have an elevator to control the pitch, immediate minor adjustments should be made while flying close to the ground. In flying a low approach (flying straight and level over the centerline of the runway at a low but specified distance from the ground), think of the throttle as the coarse and slow response altitude control, and application of both steering controls (flare) as the fine adjustments to al-

titude adjustment. Throttle has a slight delay between implementation and response in increasing altitude; flare relatively quickly increases altitude but can only hold altitude changes temporarily (about 2 seconds). This would be like applying flaps on an airplane if no elevator control was available.

While trying to maintain a constant altitude, especially when close to the ground, you can fly with about one-third flare. By holding a small flare, if you encounter downdrafts, you can immediately add a large portion of flare to lift you back to the desired altitude. If the PPC begins to climb, then you can reduce the amount of the flare to return to the desired altitude, until you can adjust your throttle position again.

Common errors in the performance of straight-and-level flight are:

- Attempting to use improper reference points on the aircraft to establish attitude.
- Forgetting the location of preselected reference points on subsequent flights.
- Attempting to establish or correct aircraft attitude using flight instruments rather than outside visual reference.
- Overcontrol and lack of feel.
- Improper scanning and/or devoting insufficient time to outside visual reference.
- Fixation on the nose (pitch attitude) reference point.
- Unnecessary or inappropriate control inputs.
- Failure to make timely and measured control inputs when deviations from straight-and-level flight are detected.
- Inadequate attention to sensory inputs in developing feel for the PPC.

## Level Turns

A turn is made by banking the wing in the direction of the desired turn. A specific angle of bank is selected by the pilot, control pressures applied to achieve the desired bank angle, and appropriate control pressures exerted to maintain the desired bank angle once it is established.

Both primary controls are used in close coordination when making level turns. Their functions are as follows.

- The steering bars bank the wings and so determine the rate of turn.
- The throttle determines vertical speed and must be increased during a turn for the PPC to remain level. The greater the degree of turn, the greater the throttle/thrust required to remain level; this is similar to an airplane and weight-shift control aircraft.

For purposes of this discussion, turns are divided into three types: shallow, medium, and steep.

- Shallow turns are those in which the bank is less than approximately 20°.
- Medium turns are those resulting from approximately 20° to 45° of bank.
- Steep turns are those resulting from 45° or more of bank. Steep turns are generally not recommended in a PPC.

Bank angle is measured in a PPC from angle of the horizon and any level component on the PPC, typically the instrument panel, steering bars, cart frame, or any other cart component that can provide a horizontal reference. Each design will have its own unique reference.

Exceeding the limitations specified in the regulations or in the aircraft pilot operating handbook is considered aerobatics and not authorized by the manufacturer limitations.

To initiate a turn, drag is created on the side of the wing you want to turn via the steering control bar, slowing and dropping that wing into the desired bank. The side without the drag is flying faster and hence pivots around the slower side. As discussed in Chapter 2, the PPC is designed to track directly into the relative air stream, similar to a weight-shift control aircraft. Therefore, no rudder is needed to coordinate a turn.

A shallow bank produces a noticeable turn but you likely will not notice an increase in load or airspeed. A constant pressure is required on the steering bar to maintain the bank angle for the turn. Abruptly releasing the pressure on the foot bar would typically bring the PPC back to straight flight because the pendulum effect is so minor.

A medium bank turn requires more PPC performance than a shallow bank. Higher and noticeable loads, plus noticeable airspeed increases are the result of a medium bank turn. After the bank has been established in a medium banked turn, pressure on the steering control must be maintained to continue the bank. If the control pressure is released, the PPC will return to the level position because of the pendulum stability discussed in Chapter 2. If it is a medium bank angle, such as 40 degrees, and the pressure is released abruptly, there will be some dampening oscillations until the PPC returns to level flight. Slower responses are required so the bank angle is reduced gradually to maintain “coordinated pendulum effect.” All PPCs have unique flying characteristics, but generally, low-

er performance “rectangular” wings would dampen quicker than higher performance “elliptical” wings.

To maintain altitude during a turn, you must directly coordinate the amount of steering input with the amount of throttle increase because of the loss in vertical lift, as covered in Chapter 2. To make a shallow turn, only a modest amount of steering control input and throttle increase is required. As the steering input is applied, you will also simultaneously apply the corresponding amount of throttle increase to maintain level flight throughout the turn.

The greater the bank angle, the greater the throttle required to remain in level flight. Also, with increased bank, greater skill is required to reduce the pendulum effect when coming out of the turn or reversing the direction of the turn. [Figure 6-5]



**Figure 6-5. To turn, coordinate increased throttle with foot steering input.**

To stop the turn and return to straight-and-level flight, you need to smoothly release the steering control input to achieve pendulum effect coordination. The pendulum stability of the PPC will do the rest to return to the straight flightpath.

All PPC controls should be manipulated with a smooth and slow motion. This will prevent pilot induced oscillation (PIO). Whether you are pushing the throttle forward to increase the pitch angle, or pushing the steering control to induce a turn, both controls should be operated smoothly and slowly—whether applying input or removing it. [Figure 6-6]

The rate at which a PPC turns is directly related to the amount of steering control input. The more input, the quicker the rate of turn. Be advised, however, if full steering input is used and adequate throttle is not



**Figure 6-6. Push the foot control and pull the steering line smoothly and slowly.**

used to compensate, the vertical component of lift is reduced significantly and a rapid descent will ensue as the turn progresses.

### Common Errors for Level Turns

- Failure to adequately clear the area before beginning the turn.
- Attempting to sit up straight, in relation to the ground, during a turn, rather than maintaining posture with the cart.
- Insufficient feel for the PPC.
- Gaining proficiency in turning in only one direction; not practicing turns in both directions.
- Failure to coordinate the throttle with the steering controls.
- Altitude gain/loss during the turn.
- Too great of a bank angle.

### Climbs and Climbing Turns, Descents and Descending Turns

To gain altitude, increase engine RPM. To lose altitude, decrease engine RPM. When a PPC enters a climb, it changes flight path from level or descending (with level or declined planes) to ascending with an inclined plane. [Figure 6-7]

Straight climbs are achieved by increasing throttle above the level flight setting and holding a straight heading. Climbing turns require more throttle than straight climbs.

During any descent, the pilot must clear the area below and to the turning side (if applicable) before beginning these maneuvers.

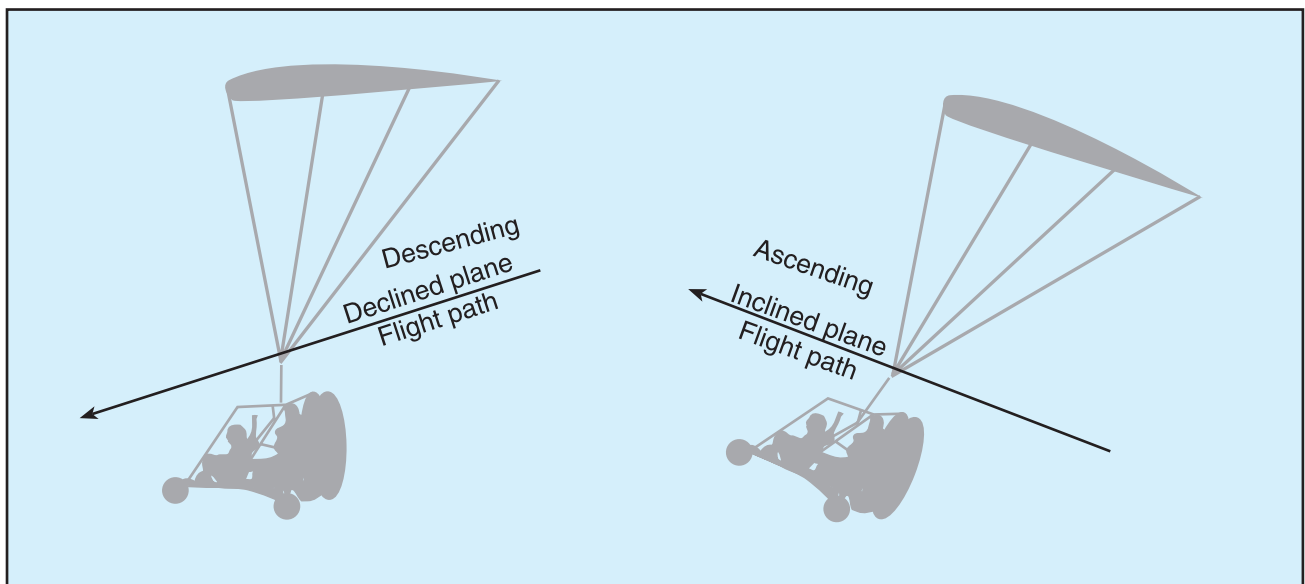

**Figure 6-7. When a PPC stabilizes in a climb or descent, the flight path is a declined or inclined plane.**

To descend, reduce throttle below the straight and level RPM while flying straight or in a turn.

Throttle reduction is the basis for determining the descent rate. Banking the aircraft will also increase the descent rate. Greater bank angles result in greater descent rates.

## Gliding

A glide is a basic maneuver in which the PPC loses altitude in a controlled descent with little or no engine power.

The PPC glide ratio is the distance the aircraft will travel forward in relation to the altitude it loses. For instance, if the aircraft travels 3,000 feet forward while descending 1,000 feet, its glide ratio is said to be 3 to 1. Wind is a major influence on the gliding distance in relationship to the PPC movement over the ground. With a tailwind, the PPC will glide farther, perhaps a 5 to 1 glide ratio because of the higher groundspeed. Conversely, with a headwind or a crosswind, the aircraft will not glide as far, perhaps a 2 to 1 glide ratio, because of the slower groundspeed.

Typically, a PPC is designed to fly efficiently near the best lift to drag ratio. Adding flare will normally decrease your speed by increasing your drag and angle of attack, reducing your glide ratio. Do not attempt to “stretch” a glide by applying flare and reducing the airspeed. Attempts to stretch a glide will invariably result in an increase in the descent rate and angle of descent.

A stabilized power-off descent is referred to as a normal glide. The flight instructor, while demonstrating a normal glide, should direct the pilot to note:

- sounds made by the PPC,
- no steering control is required except to maintain intended direction, and
- feel of the powered parachute.

## Wing Trim

The powered parachute is designed so there is no pressure needed on the flight steering controls, thus, no pulling on the trailing edge when the PPC is flying along normally. If properly trimmed, the PPC will fly straight with no pilot input except for slight variations due to left-turning tendencies. If the PPC is flying out of this basic balanced condition, one of the steering controls can be pulled down and slight pressure applied on the side to reduce the speed of the faster side wing with a trim lock to temporarily relieve the pilot of constant steering input. This trim lock is a mechanical device the pilot can set on the ground or in flight. [Figure 6-8] It holds the pressure on the side that needs it so the pilot does not have to continually apply pressure. Due to the inefficiency of increased drag, the constant use of trim locks should not be a replacement for a well set up and properly trimmed wing. Most PPCs are currently not equipped with trim locks but this will depend on the specific manufacturer and make/model. An improperly-trimmed PPC can quickly produce pilot tension and fatigue, requiring constant pressure on one of the steering bars.

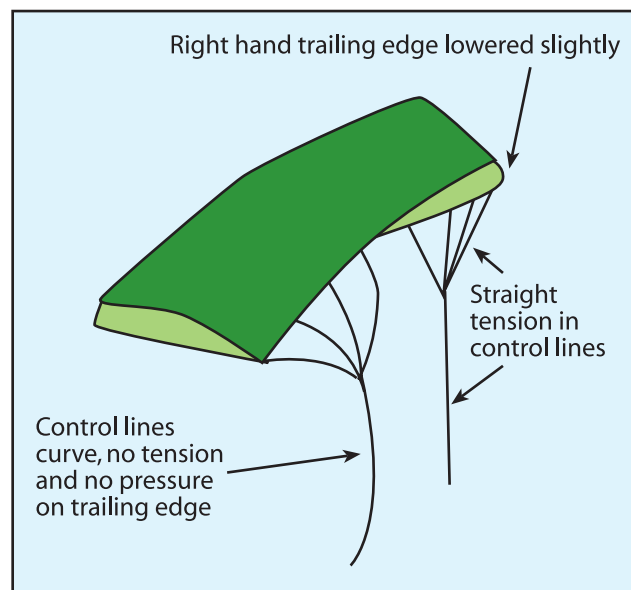

**Figure 6-8. The right trailing edge is pulled down slightly using the trim system, to correct for the left-turning tendency.**

# CHAPTER 7

## TAKEOFFS AND DEPARTURE CLIMBS

Most powered parachute incidents occur during the takeoff. This is because unlike most other types of aircraft, a powered parachute needs to create the airfoil before flight can be attempted. This critical process happens during the takeoff roll. The importance of thorough knowledge, faultless technique, and judgment cannot be overemphasized.

### Terms and Definitions

Although the takeoff and climb is one continuous maneuver, it will be divided into four separate steps for purposes of explanation:

- **Equipment staging** — the portion of the takeoff procedure during which the powered parachute is positioned and the chute is set up for takeoff.
- **Takeoff roll (ground roll)** — the portion of the takeoff procedure during which the powered parachute is accelerated from a standstill to an airspeed that provides sufficient lift for it to become airborne.
- **Rotation and liftoff** — enough lift is on the wing to rotate the nose wheel and lift the powered parachute off the ground.
- **Initial climb** — begins when the powered parachute leaves the ground and a rate of climb is established.

Normally, the process is considered complete when the powered parachute has reached a safe maneuvering altitude, or an enroute climb has been established.

### Laying Out the Wing

Refer to Chapter 5 to understand wing *inspection*, a separate procedure from wing *layout*. There are several ways to successfully lay out a powered parachute wing. What an instructor teaches is usually determined by the terrain, wind conditions, wing shape, and personal preference. There are two major layout methods: the inverted method and the stacked method.

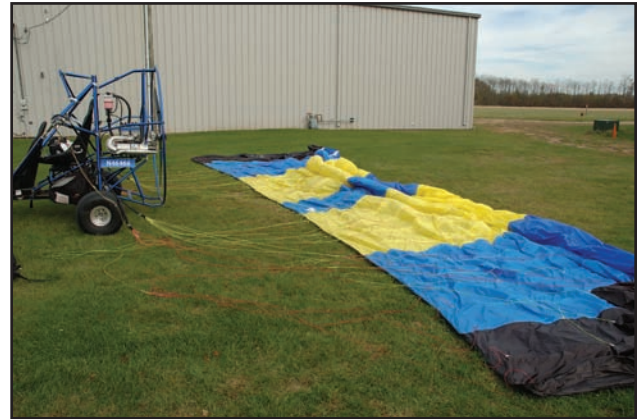

Figure 7-1. The inverted method of laying out the wing.

### The Inverted Method

The inverted method of laying out a wing involves spreading it out with the bottom surface of the wing facing up like a blanket on the beach. [Figure 7-1] The trailing edge of the wing is positioned closest to the cart and the leading edge is pulled out as far behind the cart as it will lay without pulling the cart backwards.

This method allows for a clear inspection of the wing and the attachment points of the suspension lines. It also allows the propeller blast on most carts to go over the wing, keeping it from inflating too early.

The main advantage to the inverted method is that when the cart rolls forward on the takeoff roll, it pulls the leading edge (A-lines) before it pulls the other suspension lines. This allows for a quick inflation of the wing. However, the inverted method is prone to lifting at the edges of the wing when there is wind. The wind can get under the corners of the wing and blow it up and back before you are ready to take off which can delay the proper inflation of the wing during the takeoff roll. Keep in mind that if the wind is blowing hard enough to lift the wing from its layout position, the flight conditions should be reviewed before continuing with the flight.

## The Stacked (or Accordion) Method

The stacked method of laying out a wing involves piling the wing up like an accordion with all of the suspension lines stretched out as far as possible to the rear of the cart. [Figure 7-2] The pilot can choose to change from the inverted layout to the stacked method on days where a slight wind is blowing or if the pilot is concerned with the condition of the takeoff area. Pavement or areas of the ground not covered in grass in the takeoff runway will make it necessary to get the wing off the ground with as little ground drag as possible to avoid tearing or jeopardizing the integrity of the wing fabric and/or lines.



**Figure 7-2. The stacked method of laying out the wing.**

With the wing spread out in the inverted configuration and the lines inspected, you can pull the cart forward to tighten all of the lines. This will begin the stacking process. When the slack has been removed from all lines, the pilot then goes back to the wing and finishes the stacking process by hand. This usually means taking the trailing edge of the wing and tucking it under the rest of the wing.

To complete the process of stacking the wing there are two options for laying out the leading edge. Generally, if there is no wind you may want to leave the leading edge open on top of the stack. If it is a little windy, take the leading edge and tuck it behind and under the rest of the wing. By “hiding” the leading edge over and under the rest of the wing, the wind will blow over the top of the stacked wing without catching the open edges of the wing cells. When you start the takeoff roll, the leading edge is pulled forward and up, is exposed to airflow and begins a quick inflation.

## Cockpit Management

The FAA regulations require the pilot to brief each person on board on how to fasten and unfasten his or her seatbelt and, if installed, shoulder harness. This pas-

senger briefing should be accomplished before starting the engine, to include information on the proper use of safety equipment and exiting the aircraft. You should also inform the passenger as to what to expect during takeoff, flight, and landing, what feelings and jolts are normal, what to do if the cart should roll over, and what to do if the engine fails. Make sure passengers are aware of the hazards and risks of a moving propeller and educate them on the necessity of keeping items secured so they don't get sucked through the propeller. Help them to secure their helmets (if worn) and explain how to control the intercom. Show them where to put their hands and feet and make sure any cameras or equipment are secure. A passenger should be aware that an aborted takeoff is always a possibility. Tell them everything depends upon the wing—if the wing does not inflate properly, or does not inflate and rotate in time to take off and clear an obstacle, the engine will be shut down. Finally, emergency procedures should be discussed. At a minimum, it should be explained that in the case of a rollover, the passenger should keep arms and legs inside the protected areas of the cart. In case of an accident, the passenger should not be holding onto a part of the structure that could hit the ground or an obstacle and hurt their hand or any other part of their body. The informed passenger is a safe passenger and one that will enjoy the flight.

After entering the cart, you should first ensure that all necessary equipment, documents, checklists, and navigation charts appropriate for the flight are on board and secure. If a portable intercom, headsets, or a hand-held global positioning system (GPS) is used, the pilot is responsible for ensuring that the routing of wires and cables does not interfere with the motion or the operation of any control. Regardless of what materials will be used, they should be neatly arranged and organized in a manner that makes them readily available. Loose items should be properly secured to ensure nothing goes through the propeller or departs the aircraft. All pilots should form the habit of good housekeeping.

When you are comfortably seated, fasten the safety belt and shoulder harness and adjust to a comfortably snug fit. The shoulder harness must be worn at least for the takeoff and landing, although because of the open cockpit, it is highly recommended both pilot and passenger wear seat belts at all times. If the seats are adjustable, it is important to ensure the seat is locked in position. Accidents have occurred as the result of seat movement during acceleration or pitch attitude changes during takeoffs or landings. When the seat

suddenly moves too close or too far away from the controls, you may be unable to maintain control of the powered parachute.

## Before Takeoff Check

The before takeoff check is the systematic procedure for making a final check of the engine, controls, systems, instruments, and avionics prior to flight. In addition, it gives the pilot an opportunity to establish a go or no-go decision. The engine temperatures should be rechecked, especially if any considerable amount of time has passed since the engine warm-up was completed, to make sure the engine and fluids are still within the manufacturers' recommended minimums. If the air temperature is cold, the engine will cool down faster than when the air temperature is warmer; take a few minutes to bring the engine temperature back up to minimums. Recheck the wind direction. If the wind has changed, adjust your takeoff position so you remain into the wind. Double check the steering and suspension lines are not in the way of the forward movement of the tires and the steering lines are not tangled in the riser cables.

## Start the Engine/Initial Rollout

Prime the engine, if so equipped, switch magnetos to the ON position, recheck that the throttle is not open beyond idle, and turn the electric master switch to the ON position. Visually check the area, shout "CLEAR PROP" and start the engine. Monitor the engine temperatures and check security of harnesses and helmets. Check that the strobe lights are ON, electric fuel pump is ON (if applicable), oil pressure is within limits (if applicable), and complete a final ignition system check.

Once again, the pilot has this opportunity to establish a go or no-go decision point. Check the intended runway and traffic pattern for existing traffic, and if radio equipped and a nontowered airport, announce field, type of aircraft, runway heading, and flight intentions; if a tower-controlled airport, contact ground or tower control to request a departure clearance. By adding thrust smoothly to about half to three-quarter throttle, the powered parachute will begin the takeoff roll.

## Wing Inflation and Kiting

During the takeoff roll of an airplane, the goal is to build sufficient airflow over the wing to generate the lift required to lift the aircraft off the ground. Powered parachutes have two goals during the takeoff roll: to

pressurize and raise the wing overhead making sure proper inflation exists for takeoff, and to create the airflow over the wing to generate the necessary lift. [Figure 7-3]



**Figure 7-3. Pressurizing, or kiting, the wing.**

Make a final check to confirm that the cart is pointed in the right direction and nothing has moved into the way. Look over your shoulder to observe the canopy inflation. Advance the throttle smoothly and firmly to about one-half to two-thirds takeoff power. Too abrupt an application of power may cause the cart to yank the wing too roughly forward. This can damage the riser system and shorten wing life. This is more of a problem with higher horsepower engines than in lower powered aircraft. As the cart starts to roll forward, make sure both feet are on the steering bars to begin steering the parachute immediately.

As the wing starts to rise off the ground and climb, it is acting like a parachute with lots of drag; the cart does not move forward much. As soon as the wing passes through the 50° angle to the ground, the drag dramatically decreases as the parachute becomes a wing and



the cart will begin to pick up forward speed very rapidly. You must reduce the engine thrust enough at this point to prevent the powered parachute from becoming airborne prematurely. If the initial thrust reduction is too great, the wing will begin to lose pressurization and settle back to the ground. If the thrust reduction is not adequate, the powered parachute will continue to accelerate and become airborne. On occasion the wing can become locked-out, or stuck in the prop wash; easing back on the throttle will allow the wing to settle out of the prop wash. Once again, easing the throttle smoothly forward will assist the wing in climbing through the prop wash and climb overhead above the fuselage.

As the wing is coming up in back of the cart, one side of the wing may inflate and rise faster than the other side. That higher side should be given a little bit of steering control to allow the other side of the wing to catch up. If you don't make the correction early, the wing will want to fly over to the slower-inflating side. This may create wing oscillations, especially if combined with too slow a takeoff speed. While it is important to not over-control, remember that wing controls during kiting are sluggish and more control inputs are needed than during flight.

Now is the most critical point during takeoff and possibly during the entire flight. While the parachute is inflating and rising overhead, most of the powered parachute's weight is still being carried by the wheels and the suspension system. The goal is to get the wing overhead and then transition the load from the wheels to the wing.

During the inflation and takeoff roll, you need to divide your attention between the direction the cart is going and the wing. When the wing is overhead, perform the "rolling preflight." You need to quickly inspect the wing to make sure it is fully inflated and there are no line-overs, end cell closures, pressure knots, or huge oscillations before adding full power for takeoff. This all has to be done with quick glances.

Line-overs are very easy to detect because the wing will be obviously deformed and look like it is pinched by the line that is over the top of the wing. If you see a line-over, shut down and set up again.

End cells of the wing not inflating are something additional to watch for. Most powered parachute wings have large cross-venting in the cells to allow the entire wing to pressurize evenly. Generally, the wing will pressurize in the middle first. As the pressure evens out across the wing sometimes the end cells of

the wing simply do not want to inflate. It is imperative that the pilot visually sees end cells inflate before taking off. Sometimes all you have to do is wait for the end cells to open. On some wing configurations it is recommended that the steering tubes be "pumped" lightly to help open the end cell openings.

Pressure knots are harder to determine during a rolling preflight. It may be very hard to see what is going on with the lines themselves, so the pilot may find it better to look for deformations on the bottom surface of the wing caused by one line being pulled more than it should be. Trying to take off with a pressure knot will result in the powered parachute turning very sharply to the side of the pressure knot. It will be nearly impossible to correct for that turn without nearly stalling the wing with the input on the other side. The engine will have to be kept at a very high setting just to maintain what little altitude is gained.

Wing oscillations occur for several reasons. There may not have been enough power added initially to kite the wing, or the pilot may have waited too long to correct for a wing that was flying to one side. Some light oscillation is okay, and will merely lift one side of the powered parachute into the air before the other. On the other hand large oscillations will actually change the lift from a straight upward vector to an upward and side-pulling force. An oscillating wing forced into takeoff will most likely roll the airframe, which is an undesirable cause and effect.

Oscillations are easier to prevent with good inflation techniques than they are to correct. However, if a wing is oscillating, it is possible to correct by steering the wing opposite to the side that the wing is drifting towards. In other words, manage the wing, steer it straight. The wrong inputs can make the problem worse. If the oscillations become too severe, it is best to abort the takeoff and set up again.

It is critical for the wing and lines to become verified, or fully inflated, directly overhead and centered, with the lines free of tangles. An acronym of LOC is often used to verify the wing is ready for takeoff: L – Lines Free, O – Cells Open, C – Wing Centered. Once the wing is fully pressurized, centered above the cart and the suspension and steering lines are free of tangles, slowly increase the throttle to takeoff thrust. The increased thrust accelerates the powered parachute forward until the airflow over the wing generates enough lift to get the PPC airborne. Continue to increase throttle gradually to the desired pitch attitude. Your feet have been resting on the steering bars throughout all the ground operations, and can be used to steer.

## Normal Takeoff

A normal takeoff is one in which the powered parachute is headed into the wind and the wind is light to moderate. [Figure 7-4] The takeoff surface should be firm, free of debris, and not have any obstructions along the takeoff path. The takeoff surface should have sufficient length to permit the powered parachute to quickly accelerate to normal flight speed.

There are three reasons for making a takeoff as directly into the wind as possible:

1. A slower ground speed reduces wear and stress on the landing gear;
2. The headwind helps inflate the wing and get it overhead more quickly;
3. A shorter ground roll, and therefore less runway length, is required to lift off.



**Figure 7-4. The powered parachute should be headed into the wind during takeoff.**

### Takeoff Roll

Once there is a commitment to take off, it takes a minimum airspeed to keep the wing inflated. Inflating the chute, then cutting the power, will usually result in the wing deflating and falling to the ground. This can be difficult to recover from and should only be done if you wish to abort the takeoff.

Otherwise, as the speed of the takeoff roll increases, more and more pressure will be felt on the steering control tubes. It is important during this time to keep the wing going in the same direction as the cart. This means using the ground controls and/or the flight controls to keep the cart and the wing coordinated.

After kiting the wing and performing the LOC preflight check as discussed in Chapter 5, takeoff power is applied and you accelerate to flying speed.

### Rotation

When the wing has enough lift to rotate the cart nose off of the ground, nosewheel steering becomes ineffective. This means that even though the back wheels of the machine are still on the ground, the cart will be steered by the wing. You should not attempt any kind of tight radius turn during this process.

### Lift-Off

Once the wing is overhead and enough power is added, the powered parachute will lift off the ground.

### Initial Climb

Once the cart is off the ground, it is important to maintain at least the same throttle setting that got it off the ground in the first place. When the cart is free from ground friction on the landing gear, it will begin to climb.

Once the powered parachute is off the ground, prop torque may become noticeable. It will typically steer the aircraft to the left (with a clockwise spinning propeller). Wind can also affect the direction of the PPC after liftoff. During initial climb, it is important that the initial climb path remain aligned with the runway to avoid drifting into obstructions, or the path of another aircraft that may be taking off from a parallel runway. Proper scanning techniques are essential to a safe takeoff and climb, not only for maintaining attitude and direction, but also for collision avoidance in the airport area.

The powered parachute's takeoff performance will be much different when there is less weight with only one person in the PPC. Due to decreased load, the powered parachute will become airborne sooner, climb more rapidly, climb at a much steeper angle, and the flight controls may seem more sensitive.

Common errors in the performance of normal takeoffs and departure climbs are:

- Failure to adequately clear the area prior to taxiing into the staging position.
- Poor selection of a staging position. (Not allowing for enough takeoff area.)
- Failure to set up the powered parachute into the wind.
- Abrupt use of the throttle resulting in additional stress on the wing during inflation.
- Not using enough power to kite the wing.
- Failure to observe the wing during inflation.
- Failure to perform the rolling LOC preflight to clear the wing.

- Abrupt use of the throttle resulting in the aircraft porpoising.
- Failure to anticipate the left turning tendency (as discussed in Chapter 2) on initial acceleration.
- Overcorrecting for left turning tendency.

## Centering the Wing

The steering controls can be used to reduce the wing's side-to-side oscillation, or assist with the centering of the wing during the rolling (takeoff) preflight. For example, if the wing is far left of center, and is beginning to move back to center (from left to right) you can add some left control pressure to slow the wing's (right moving) inertia and thus keep it from overshooting the center position above the cart. Or, if the wing is far right of center and you want to begin the wing's motion back to its normal and safe position above the cart, you could help initiate the wing's motion to the left by applying slight left steering pressure.

## Encourage Cell Openings

During the pretakeoff roll (when building and verifying your wing before takeoff—particularly if operating on a soft field) you may find it useful to press the pedals multiple times, and hold it (about half a second) after the wing comes overhead. This has two beneficial uses. First, it assists with opening the outside cells by temporarily increasing internal wing pressure, pushing the air forward and transferring the pressure out to the tips. Second, it helps confirm the steering lines are clear of any impediments, ensuring they are not caught on or wrapped around any outrigger tubing or obstructions.

## “Lock-out” Avoidance

Improper canopy layout, wind conditions, or inappropriate throttle movements during the initial building of the wing during your takeoff roll may cause the wing to “lock-out” or stall behind the cart at a 30 to 45 degree angle on its rise. To correct the lock-out, reduce power and push both steering controls simultaneously out in a flaring motion until the wing is pulled back to where the tail is almost touching the ground. Then rapidly release the flare so the wing “sling-shots” up and overhead of the cart. Note: This method is not recommended with elliptical shaped wings, as these wings, with their reduced drag, may over-fly the cart and land ahead of the rolling cart.

## Crosswind Takeoff

Powered parachutes have very limited crosswind capability. You should take off directly into the wind. If the wind is slowly changing direction and the powered parachute is positioned to take off into a crosswind, it is better to wait and see if the winds will change back to headwinds before committing to a takeoff. If winds are changing direction very quickly, the flight should be cancelled.

Sometimes there is only one runway and the winds are blowing across it. It is still possible to take off, but it will involve positioning the powered parachute so the initial inflation and roll will be into the wind. If you fly at a field that has only one main runway, you must be familiar with the principles and techniques involved in crosswind takeoffs or not fly when there is a crosswind.

## Positioning the Cart

In all but the lightest of crosswinds, it is still a good idea to position the powered parachute into the wind. Lay out the powered parachute wing directly into the wind, as you would for a normal takeoff. [Figure 7-5]

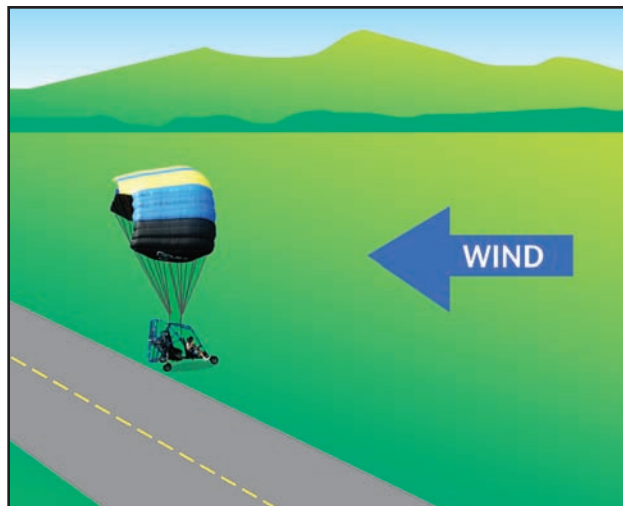

Figure 7-5. Initial inflation.

## Wing Inflation and Kiting

The initial inflation and kiting should be done as it would be for a normal takeoff. As soon as the wing is overhead and flying, steer the cart into the direction desired for takeoff. This procedure requires practice coordinating the controls for the ground steering and the wing. The wing needs to be producing some lift before the turn can be attempted. This may mean a more aggressive inflation and kiting if the takeoff area is relatively small.

## Takeoff Roll

The technique used during the initial takeoff roll in a crosswind is generally the same as used in a normal takeoff, the wing should be turned approximately into the wind; this is done with steering bar control held to the side from which the crosswind is blowing. This will help keep the wing from pulling the cart to the down wind side. It is important there is sufficient airspeed over the wing to create lift. Otherwise, the wing will have a tendency to fall towards the downwind side of the powered parachute. This exposes the powered parachute to a rollover since the wind will be blowing into the bottom of the wing that is now acting as a sail, thereby pulling the cart over.

The sequence of events will usually be moving fast during a crosswind takeoff, but it is still important to do a rolling preflight: LOC.

## Lift-Off

As the nosewheel is being raised off the runway, the steering control for the powered parachute is transferred fully to the wing flight controls.

If a significant crosswind exists, it will take longer for the powered parachute to take off because the steering control adds drag to the wing. This may be naturally compensated for by the headwind component of the wind as well as the tendency for the deflected side of the wing to act as a flared wing.

As both main wheels leave the runway and ground friction no longer resists drifting, the powered parachute will be slowly carried sideways with the wind unless you maintain adequate drift correction. Therefore, it is important to establish and maintain the proper amount of crosswind correction prior to lift-off by continuing to apply steering bar pressure.

## Initial Climb

If proper crosswind correction is being applied, as soon as the powered parachute is airborne, the cart will rotate so it is lined up with the wing. Firm and aggressive use of the steering bars may be required to keep the powered parachute crabbed down the intended takeoff path. Continue the climb with a wind correction angle to follow a ground track aligned with the runway centerline or takeoff path direction. However, because the force of a crosswind may vary markedly within a few hundred feet of the ground, make frequent checks of actual ground track, and adjust the crab angle as necessary. The remainder of the climb technique is the same used for normal takeoffs and climbs.

Common errors in the performance of crosswind takeoffs are:

- Failure to adequately clear the area prior to taxiing into the staging position.
- Poor selection of a staging position.
- Not allowing for enough takeoff area.
- Not allowing for enough area to kite the wing and turn to the intended takeoff path.
- Failure to set up the powered parachute into the wind.
- Not using enough power to kite the wing.
- Failure to observe the wing during inflation.
- Failure to perform a rolling preflight (LOC).
- Failure to maintain enough thrust to keep the wing properly loaded during the turn and alignment with the intended takeoff path.

## Rejected Takeoff/Engine Failure

Emergency or abnormal situations can occur during a takeoff that will require you to reject the takeoff while still on the runway. Circumstances such as a malfunctioning powerplant, inadequate acceleration, inadequate wing kiting, runway incursion, or air traffic conflict may be reasons for a rejected takeoff.

Prior to takeoff, you should have in mind a point along the runway at which the powered parachute should be airborne. If that point is reached and the powered parachute is not airborne, take immediate action to discontinue the takeoff. Properly planned and executed, chances are excellent the powered parachute can be stopped on the remaining runway without using extraordinary measures, such as excessive braking or trying to stop by using your feet as brakes. Neither of these measures should be used and may result in powered parachute damage and/or personal injury. In the event a takeoff is rejected, reduce the power to idle and shut down the engine. Immediately, pull down the trailing edge to collapse the wing so it can be used as a drogue chute, semi-inflated behind you.

Urgency characterizes all power loss or engine failure occurring after lift-off. In most instances, the pilot has only a few seconds after an engine failure to decide and execute the proper course of action. In the event of an engine failure on initial climb-out, the powered parachute will be at a high pitch angle, with the cart well in front of the wing. When the engine fails, the cart will rock back under the parachute, possibly causing a temporary but potentially dangerous dive. The level of danger in the dive is dependent on how high the PPC is above the ground when the engine fails. The best situation is if the pilot can establish a normal

glide and execute a normal engine-out landing (see Chapter 12). However, if the engine-out occurs close to the ground, it may be necessary to immediately flare the parachute so the parachute does not rotate over the cart and into a dive which will increase the descent rate.

## Runway Surface and Gradient

Runway conditions affect takeoff performance. Typically, powered parachutes take off from level grassy surfaces. However, runway surfaces vary widely from one airport to another. The runway surface for a specific airport is noted in the Airport/Facility Directory (A/FD). Any surface that is not hard and smooth will increase the ground roll during takeoff. This is due to the inability of the tires to smoothly roll along the surface. Tires can sink into soft, grassy, or muddy runways. Holes or other ruts in the surface can be the cause of poor tire movement along the surface. Obstructions such as mud, snow, or standing water reduce the powered parachute's acceleration down the runway. Many of these same hindrances are multiplied in effect by the use of soft or wide tires that increase resistance themselves.

The gradient or slope of the runway is the amount of change in runway height over the length of the runway. The gradient is expressed as a percentage such as a 3 percent gradient. This means that for every 100 feet of runway length, the runway height changes by 3 feet. A positive gradient indicates that the runway height increases, and a negative gradient indicates that the runway decreases in height. An upsloping runway impedes acceleration and results in a longer ground run during takeoff. A downsloping runway aids in acceleration on takeoff resulting in shorter takeoff distances. Runway slope information is contained in the Airport/Facility Directory.

## Takeoff Performance

Takeoff performance is partly a condition of accelerated motion. For instance, during takeoff, the powered parachute starts at zero speed and accelerates to inflate the wing, then to takeoff speed and becomes airborne. The important factors of takeoff performance are as follows:

- The takeoff speed.
- The rate of acceleration during the takeoff roll.
- The takeoff roll distance is a function of both acceleration and speed.

The minimum takeoff distance is of primary interest in the operation of any powered parachute because it defines the runway requirements. The minimum takeoff distance is obtained by taking off on a length of runway that allows sufficient margin to inflate the wing, perform the LOC procedure, and then satisfactory room to initiate a lift-off and climb.

The powerplant thrust is the principal force providing the acceleration and — for minimum takeoff distance — the output thrust should be at the maximum after the wing is inflated and successful LOC procedure performed. Use smooth, gradual throttle settings to avoid porpoising. Drag is produced as soon as the powered parachute moves forward. The drag of the wing decreases as it rotates into position over the cart.

In addition to the important factors of proper procedures, many other variables affect the takeoff performance of a powered parachute. Any item that alters the takeoff speed or acceleration rate during the takeoff roll will affect the takeoff distance.

The most important variable to affect the takeoff performance is how fast the pilot can get the wing overhead, centered, and ready to take the load of the cart. Often, most of the runway used will be for the inflation and wing LOC procedure. Unlike almost any other type of flight, a powered parachute pilot has to create the airfoil and clear it on the ground before lift-off. It is always best to practice this skill at a longer field where mistakes can be made and corrected in plenty of time before taking off.

Even a slight headwind will have a dramatic effect on takeoff distances for powered parachutes because a wind helps inflate a wing much faster than can be done on a calm day. Even light winds can be a large percentage of the flying speed of a powered parachute. A powered parachute that flies at 35 mph taking off into a headwind of only 3.5 mph is working with a 10 percent headwind. A headwind that is 10 percent of the takeoff airspeed will reduce the takeoff distance approximately 19 percent. In the case where the headwind is 50 percent of the takeoff speed (a brisk 17.5 mph), the takeoff distance would be approximately 25 percent of the zero wind takeoff distance (75 percent reduction).

Gross weight also has an effect on takeoff distance. Proper consideration of this item must be made in predicting the powered parachute's takeoff distance. Increased gross weight can be considered to produce a threefold effect on takeoff performance:

1. Higher lift-off speed,
2. Greater mass to accelerate, and
3. Increased retarding force (drag and ground friction).

If the gross weight increases, a greater speed is required to produce the greater lift necessary to get the powered parachute airborne at the takeoff lift coefficient. As an example of the effect of a change in gross weight for a typical PPC, a 21 percent increase in takeoff weight will require a 10 percent increase in lift-off speed to support the greater weight.

A change in gross weight will change the net accelerating force and the mass that is being accelerated.

The takeoff distance will vary at least as the square of the gross weight. Adding a 200-pound passenger to a machine that already weighs 400 pounds, with a pilot weighing 200 pounds, will increase the gross weight by 33 percent. That increase of one passenger will degrade the performance of the powered parachute dramatically. The 33 percent increase in takeoff gross weight would cause:

- At least a 25 percent decrease in rate of acceleration, and
- At least a 76 percent increase in takeoff distance.

For the powered parachute with a high thrust-to-weight ratio, the increase in takeoff distance might be approximately 76 percent, but for the powered parachute with a relatively low thrust-to-weight ratio, the increase in takeoff distance would be more. Such a powerful effect requires proper consideration of gross weight in predicting takeoff distance.

The effect of pressure altitude and ambient temperature is to define primarily the density altitude and its effect on takeoff performance. While subsequent corrections are appropriate for the effect of temperature on certain items of powerplant performance, density altitude defines specific effects on takeoff performance. An increase in density altitude can produce a fourfold effect on takeoff performance:

1. Greater takeoff speed.
2. Decreased thrust and reduced net accelerating force.
3. Reduced rate of climb.
4. Increased runway required.

If a powered parachute of given weight and configuration is operated at greater heights above standard sea level, it will still require the same dynamic pressure to become airborne. Thus, the powered parachute at

altitude will take off at the same indicated airspeed as at sea level, but because of the reduced air density, the true airspeed will be greater.

Proper accounting of pressure altitude (field elevation is a poor substitute) and temperature is mandatory for accurate calculation of takeoff roll distance.

The most critical conditions of takeoff performance are the result of some combination of high gross weight, altitude, temperature, and unfavorable wind. In all cases, the pilot must make an accurate calculation of takeoff distance from the performance data of the AFM/POH, regardless of the runway available, and strive for a polished, professional takeoff procedure. In the calculation of takeoff distance from the AFM/POH data, the following primary considerations must be given:

- Pressure altitude and temperature — to define the effect of density altitude on distance.
- Gross weight — a large effect on distance.
- Wind — a large effect on wing inflation and overall distance.
- Runway slope and condition — the effect of an incline and the retarding effect of factors such as snow, ice, or uncut grass.

## Noise Abatement

Aircraft noise problems have become a major concern at many airports throughout the country. Many local communities have pressured airports into developing specific procedures that will help limit aircraft noise while operating over nearby areas. For years now, the FAA, airport managers, aircraft operators, pilots, and special interest groups have been working together to minimize aircraft noise for nearby sensitive areas. As a result, noise abatement procedures have been developed for many of these airports that include standardized profiles and procedures to achieve these lower noise goals.

Standard noise abatement procedures don't necessarily apply to powered parachutes, but similar issues exist. Powered parachutes fly at lower altitudes, fly tighter patterns, and tend to fly early in the morning and late in the evening when the winds are lightest. Powered parachute pilots should actively work with airport management to determine takeoff areas, patterns, and procedures that emphasize both safety and good neighborhood relations.

Specific noise abatement flight procedures are found in the A/FD where runway surface, slope and elevation can be found for flight planning.



# CHAPTER 8

## AIRSPACE CLASSIFICATION AND REQUIREMENTS

This chapter introduces the various classifications of airspace and provides information on the requirements to operate in such airspace. For further information, consult the *Pilot's Handbook of Aeronautical Information*, the *Aeronautical Information Manual* (AIM) and Title 14 of the Code of Federal Regulations (14 CFR) parts 71, 73, and 91.

Powered parachutes (PPC) share the airspace with all other types of aircraft and must avoid the flow of fixed wing aircraft. Although most PPCs fly low, slow and close to the field, you must be aware of the airspace in which you are operating. Each type of airspace has communication, equipment, visibility and cloud clearance requirements, and therefore may require additional pilot training with logbook endorsements. Some airspace may not be accessible (Class A) while other airspace (Class B and Class C) may not be prudent for PPC operation. Knowing the types of airspace and their requirements is necessary for safe and proper PPC operations.

The two categories of airspace are: regulatory and non-regulatory. Within these two categories, there are four types: controlled, uncontrolled, special use, and other airspace.

Each type of airspace may have different minimum pilot certification, equipment, visibility and cloud clearance, and entry requirements.

Figure 8-1 presents a profile view of the dimensions of various airspace classes. Figure 8-2 provides the basic weather minimums for operating in the different airspace classes. Figure 8-3 lists the operational and equipment requirements. Refer to these figures as you review this chapter.

### Controlled Airspace

Controlled airspace is a generic term that covers the different classifications of airspace and defined dimensions within which air traffic control service is provided in accordance with the airspace classification. Controlled airspace consists of Class A, Class B, Class C, Class D, and Class E.

### Class A Airspace

Class A airspace is generally the airspace from 18,000 feet mean sea level (MSL) up to and including 60,000 feet (FL600), including the airspace overlying the

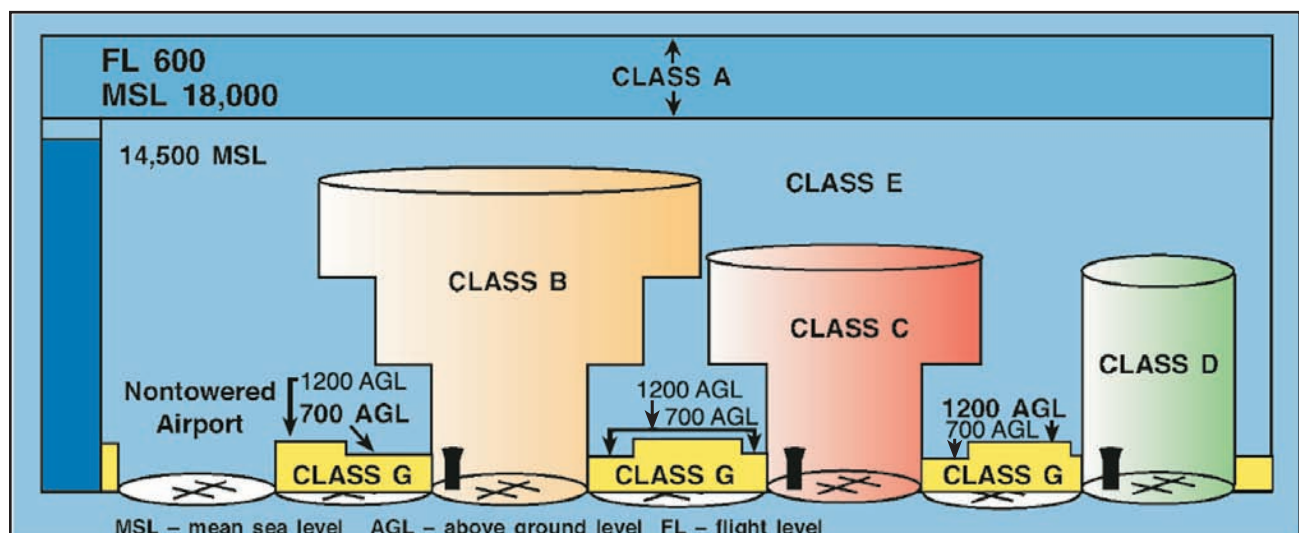

Figure 8-1. Airspace at a glance.



waters within 12 nautical miles (NM) of the coast of the 48 contiguous states and Alaska. Unless otherwise authorized, all operation in Class A airspace will be conducted under instrument flight rules (IFR). It is not likely PPCs will be operated in Class A airspace.

## Class B Airspace

Class B airspace is generally the airspace from the surface to 10,000 feet MSL surrounding the nation's busiest airports. The configuration of Class B airspace is individually tailored to the needs of a particular area and consists of a surface area and two or more layers. Some Class B airspace resembles an upside-down wedding cake. At least a private pilot certificate

is required to operate in Class B airspace; however, there is an exception to this requirement. Student pilots, recreational pilots, and sport pilots may operate in the airspace if they have received training and a logbook endorsement by an authorized flight instructor in accordance with 14 CFR part 61.

With proper communication equipment, a Mode C transponder (a device that transmits your exact position and altitude), pilot certification and endorsements as required, and an air traffic control (ATC) clearance, a powered parachute may operate in Class B airspace. Due to large jets and congested traffic operating in Class B airspace, powered parachute operations may not be advised.

BASIC VFR WEATHER MINIMUMS		
Airspace*	Flight Visibility*	Distance from Clouds
Class A .....	Not Applicable	Not Applicable
Class B .....	3 statute miles	Clear of Clouds
Class C .....	3 statute miles	500 feet below 1,000 feet above 2,000 feet horizontal
Class D .....	3 statute miles	500 feet below 1,000 feet above 2,000 feet horizontal
Class E Less than 10,000 feet MSL .....	3 statute miles	500 feet below 1,000 feet above 2,000 feet horizontal
At or above 10,000 feet MSL* .....	5 statute miles	1,000 feet below 1,000 feet above 1 statute mile horizontal
Class G 1,200 feet or less above the surface (regardless of MSL altitude). Day, except as provided in section 91.155(b). .....	1 statute mile*	Clear of Clouds
Night, except as provided in section 91.155(b). .....	3 statute miles	500 feet below 1,000 feet above 2,000 feet horizontal
More than 1,200 feet above the surface but less than 10,000 feet MSL. Day .....	1 statute mile*	500 feet below 1,000 feet above 2,000 feet horizontal
Night* .....	3 statute miles	500 feet below 1,000 feet above 2,000 feet horizontal
More than 1,200 feet above the surface and at or above 10,000 feet MSL.* .....	5 statute miles	1,000 feet below 1,000 feet above 1 statute mile horizontal

\* Sport pilots must maintain 3 SM or better visibility in all airspace. Sport pilots are not authorized to fly above 10,000 feet MSL. Sport pilots are not authorized to fly at night.

Figure 8-2. Basic weather minimums, from 14 CFR 91.155 and 14 CFR 61.315.

When associated with Class B airspace and within 30 nautical miles of the primary airport, aircraft must be equipped with a Mode C transponder. This requirement must be complied with even if there is no intent to enter the Class B airspace.

### Class C Airspace

Class C airspace generally surrounds those airports having an operational control tower, are serviced by a radar approach control, and with a certain number of instrument flight (IFR) operations or passenger enplanements. This airspace is charted in mean sea level feet. Although the configuration of each Class C airspace is individually tailored, the airspace usually consists of a 5 NM radius core surface area that extends from the surface up to 4,000 feet above the airport elevation, and a 10 NM radius shelf area that extends no lower than 1,200 feet up to 4,000 feet above the airport elevation. Though not requiring regulatory action, Class C airspace areas have a procedural Outer Area. Normally this area is 20 NM from the primary Class C airspace airport. Within the outer area, pilots are encouraged to participate but it is not a VFR requirement. With proper communication equipment, a Mode C transponder, endorsements as required, and two-way communications established, a powered parachute may operate in Class C airspace though it may still not be advisable. A Mode C transponder is also required for overflying the Class C airspace.

### Class D Airspace

Class D airspace is for smaller airports operating with a control tower and generally extends from the surface to 2,500 feet above the airport elevation surrounding those airports that have an operational control tower. The configuration of Class D airspace will be tailored to meet the operational needs of the area. At many Class D airports, the airspace is configured as a circle with a 4 nautical mile radius around the primary airport. Some are keyhole shaped. With the proper communication equipment, endorsements as required, and two-way communications established with ATC, a powered parachute may operate within Class D. If advised by ATC to remain clear of the Class D airspace the powered parachute pilot must comply and remain clear of the Class D airspace. Alternatives may include circumnavigating the Class D airspace and/or landing at an alternative airport.

### Class E Airspace

Class E airspace is generally controlled airspace that is not designated A, B, C, or D. Except for 18,000 feet MSL, Class E airspace has no defined vertical limit, but rather it extends upward from either the surface or a designated altitude to the overlying or adjacent controlled airspace. With visibility and cloud clearance requirements met, powered parachute operations are not restricted. Most PPC operations take place in Class E airspace.

Class Airspace	Entry Requirements	Equipment	Minimum Pilot Certificate
A	ATC Clearance	IFR Equipped	Instrument Rating
B	ATC Clearance	Two-Way Radio, Transponder with Altitude Reporting Capability	Private—Except a student or recreational pilot may operate at other than the primary airport if seeking private pilot certification and if regulatory requirements are met. †
C	Two-Way Radio Communications Prior to Entry	Two-Way Radio, Transponder with Altitude Reporting Capability	†
D	Two-Way Radio Communications Prior to Entry	Two-Way Radio	†
E	None for VFR	No Specific Requirement	No Specific Requirement
G	None	No Specific Requirement	No Specific Requirement

† Sport pilots must have training and a logbook endorsement.

Figure 8-3. Requirements for airspace operations from 14 CFR 61.325.

# Uncontrolled Airspace: Class G Airspace

Uncontrolled or Class G airspace is the portion of the airspace that has not been designated as Class A, B, C, D, or E. It is therefore designated uncontrolled airspace. Class G airspace extends from the surface to the base of the overlying Class E airspace. Although air traffic control has no authority or responsibility to control air traffic in Class G airspace, you should remember there are visual flight rule (VFR) minimums (visibility and cloud clearance) which apply to Class G airspace.

## Special Use Airspace

Special use airspace exists where activities must be confined because of their nature. In special use airspace, limitations may be placed on aircraft that are not a part of the activities. Special use airspace usually consists of:

- Prohibited Areas.
- Restricted Areas.
- Warning Areas.
- Military Operation Areas.
- Alert Areas.
- Controlled Firing Areas.

It is important you review the current sectional chart for the area you will be flying in to make sure you avoid operating in special use airspace without proper training and authority. [Figure 8-4]

## Prohibited Areas

Prohibited areas are established for security or other reasons associated with the national welfare. Prohibited areas are published in the Federal Register and are depicted on aeronautical charts.

## Restricted Areas

Restricted areas denote the existence of unusual, often invisible hazards to aircraft such as artillery firing, aerial gunnery, or guided missiles. An aircraft may not enter a restricted area unless permission has been obtained from the controlling agency. Restricted areas are depicted on aeronautical charts and are published in the Federal Register. Restricted areas may have altitude limitations and hours of operation. Aircraft operations are not restricted if the restricted area is not active.

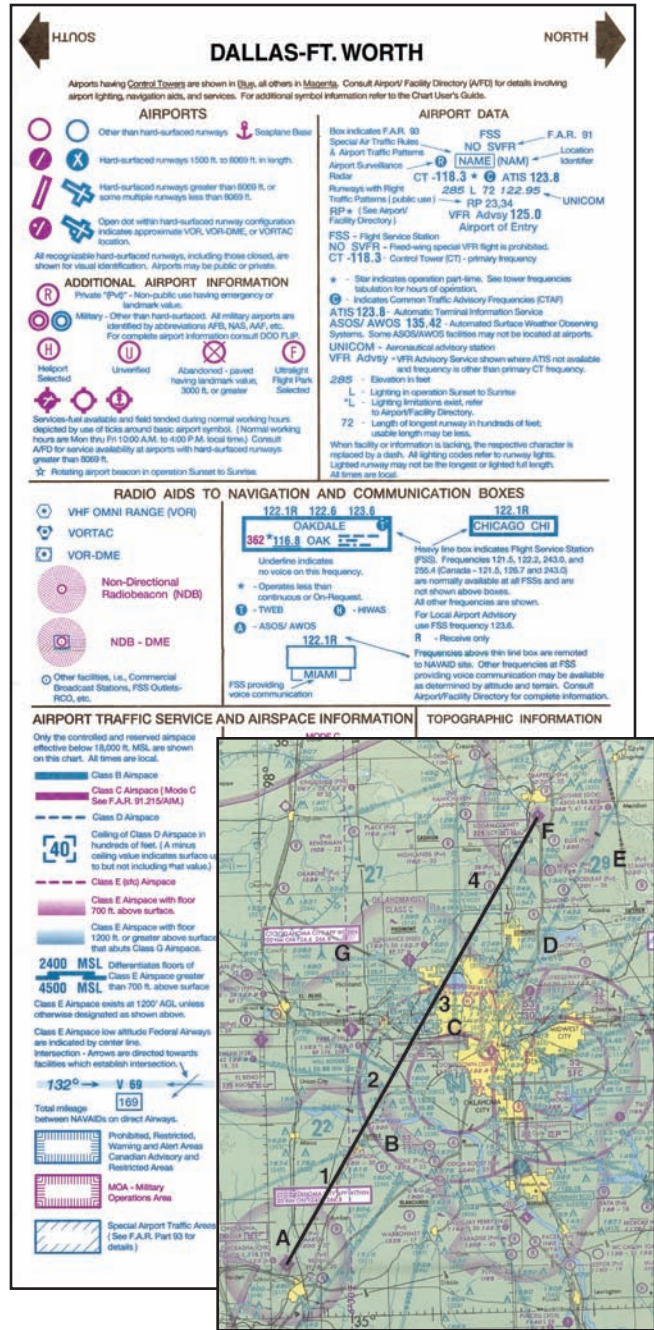

Figure 8-4. Your preflight preparations should include studying the sectional chart to determine in which airspace you will be operating.

## Warning Areas

Warning areas consist of airspace which may contain hazards to nonparticipating aircraft in international airspace. The activities may be much the same as those for a restricted area. Warning areas are established beyond the 3-mile limit. Warning areas are depicted on aeronautical charts.

## **Military Operation Areas**

Military operation areas (MOA) consist of airspace of defined vertical and lateral limits established for the purpose of separating certain military training activity from IFR traffic. There is no restriction against a pilot operating VFR in these areas; however, a pilot should be alert since training activities may include acrobatic and abrupt maneuvers. MOAs are depicted on aeronautical charts. MOAs may have altitude limitations and hours of operation.

## **Alert Areas**

Alert areas are depicted on aeronautical charts and advise pilots that a high volume of pilot training or unusual aerial activity is taking place. You should be particularly vigilant while flying in this airspace due to the high volume of training activities.

## **Controlled Firing Areas**

Controlled firing areas contain activities, which, if not conducted in a controlled environment, could be hazardous to nonparticipating aircraft. The difference between controlled firing areas and other special use airspace is that activities must be suspended when a spotter aircraft, radar, or ground lookout position indicates an aircraft might be approaching the area.

## **Other Airspace Areas**

“Other airspace areas” is a general term referring to the majority of the remaining airspace. It includes:

- Airport Advisory Areas.
- Military Training Routes (MTR).
- Temporary Flight Restrictions (TFRs).
- Parachute Jump Areas.
- Published VFR Routes.
- Terminal Radar Service Areas.
- National Security Areas.
- Flights over Charted U.S. Wildlife Refuges, Parks, and Forest Service Areas.

## **Airport Advisory Areas**

An airport advisory area is an area within 10 statute miles (SM) of an airport where a control tower is not operating, but where a flight service station (FSS) is located. At these locations, the FSS provides advisory service to arriving and departing aircraft.

## **Military Training Routes**

Military training routes (MTR) are developed to allow the military to conduct low-altitude, high speed training. The routes above 1,500 feet AGL are developed to be flown primarily under IFR, and the routes 1,500 feet and less are for VFR flight. The routes are identified on sectional charts by the designation “instrument (IR) or visual (VR).” MTRs with no segment above 1,500 feet AGL are identified by four number characters; e.g., IR1206, VR1207. MTRs that include one or more segments above 1,500 feet AGL are identified by three number characters; e.g., IR206, VR207.

## **Temporary Flight Restrictions**

An FDC Notice to Airmen (NOTAM) will be issued to designate a temporary flight restriction (TFR). The NOTAM will begin with the phrase “FLIGHT RESTRICTIONS” followed by the location of the temporary restriction, effective time period, area defined in statute miles, and altitudes affected. The NOTAM will also contain the FAA coordination facility and telephone number, the reason for the restriction, and any other information deemed appropriate. You should check the NOTAMs as part of flight planning. Flight Service (1-800-WX-BRIEF) can advise you on current TFRs.

Some of the purposes for establishing a temporary restriction are:

- Protect persons and property in the air or on the surface from an existing or imminent hazard.
- Provide a safe environment for the operation of disaster relief aircraft.
- Prevent an unsafe congestion of sightseeing aircraft above an incident or event, which may generate a high degree of public interest.
- Protect declared national disasters for humanitarian reasons in the State of Hawaii.
- Protect the President, Vice President, or other public figures.
- Provide a safe environment for space agency operations.

## **Parachute Jump Areas**

Parachute jump areas are published in the Airport/Facility Directory. Sites that are used frequently are depicted on sectional charts.

## Published VFR Routes

Published VFR routes are for transitioning around, under, or through some complex airspace. Terms such as VFR flyway, VFR corridor, Class B airspace, VFR transition route, and terminal area VFR route have been applied to such routes. These routes are generally found on VFR terminal area planning charts.

## Terminal Radar Service Areas

Terminal Radar Service Areas (TRSA) are areas where participating pilots can receive additional radar services. The purpose of the service is to provide separation between all IFR operations and participating VFR aircraft.

The primary airport(s) within the TRSA become(s) Class D airspace. The remaining portion of the TRSA overlies other controlled airspace, which is normally Class E airspace beginning at 700 or 1,200 feet and established to transition to/from the en route terminal environment. TRSAs are depicted on VFR sectional charts and terminal area charts with a solid black line and altitudes for each segment. The Class D portion is charted with a blue segmented line.

Participation in TRSA services is voluntary; however, pilots operating under VFR are encouraged to contact the radar approach control and take advantage of TRSA service.

## National Security Areas

National security areas consist of airspace of defined vertical and lateral dimensions established at locations where there is a requirement for increased security and safety of ground facilities. Pilots are requested to voluntarily avoid flying through these depicted areas. When necessary, flight may be temporarily prohibited.

National security areas can be changed to TFRs with very little notice. Check the status of the airspace with the FSS before flying through a national security area.

## Flight Over Charted U.S. Wildlife Refuges, Parks, and Forest Service Areas

The landing of aircraft is prohibited on lands or waters administered by the National Park Service, U.S. Fish and Wildlife Service, or U.S. Forest Service without

authorization from the respective agency. Exceptions include:

1. When forced to land due to an emergency beyond the control of the operator;
2. At officially designated landing sites; or
3. An approved official business of the Federal Government.

Pilots are requested to maintain a minimum altitude of 2,000 feet above the surface of the following: National Parks, Monuments, Seashores, Lakeshores, Recreation Areas and Scenic River ways administered by the National Park Service, National Wildlife Refuges, Big Game Refuges, Game Ranges and Wildlife Ranges administered by the U.S. Fish and Wildlife Service, and Wilderness and Primitive areas administered by the U.S. Forest Service.

## Powered Parachute Operations

PPC preflight planning should include a review of the airspace that will be flown. A local flight may be close to the field and include only Class G and Class E airspace. Minimum visibility and cloud clearance may be the only requirements for both the pilot and the powered parachute.

If you will be flying through controlled airspace, you must determine if the PPC meets all of the equipment requirements of that airspace. [Figure 8-3] You must also review your qualifications to determine if you meet the minimum pilot requirements of the airspace. If you or the PPC do not meet the minimum aircraft and/or pilot requirements of the airspace, then the preflight planning should include a course around the airspace. Extra time and fuel will be required for the circumnavigation and should be taken into consideration prior to departure. With proper preflight planning, transition or circumnavigation of the controlled airspace should not be a problem for the pilot or the powered parachute.

## PPC and Air Traffic Control

In uncontrolled airspace separation from other aircraft is the responsibility of the pilot. Separation from higher speed traffic may require flight paths different than faster traffic. The PPC pilot may be asked to expedite or deviate from a traditional course. The PPC pilot must work with ATC in advising of the airspeed limitations and surface wind speed and direction limitations. Safe operation in controlled airspace requires that the controller understand the limits of the powered parachute.

In uncontrolled airspace the responsibility for separation from other aircraft is the responsibility of the pilot. The PPC pilot must be aware that the pilot of the other aircraft may not understand the requirements and/or limitations of the PPC. In operations at uncontrolled airports 14 CFR part 91 requires that PPCs avoid the flow of fixed-wing aircraft.

Regardless of the airspace, see and avoid is a key element of flying in a PPC. The slow speed of the PPC allows it to be overtaken by higher performance aircraft quickly. Vigilance and proper scanning techniques are extremely important in all airspace, particularly when operating around nontowered airports.

## **Navigating the Airspace**

Knowledge of airspace dimensions, requirements to enter the airspace and geographical location of the airspace is the responsibility of all pilots. The current sectional chart is the primary official tool to determine the airspace you are flying within or trying to avoid.

Pilotage is navigation by reference to landmarks to determine your location and the location of airspace. Pilotage is the best form of navigation to ensure that you avoid airspace you are not authorized to enter. Locating your position on the sectional chart and locating/identifying the airspace you want to enter/avoid requires preflight planning on the ground and situational awareness in the air.

GPS is a very popular form of navigation use by powered parachute pilots. The GPS receiver is small, simple to use and inexpensive compared to other forms of electronic (radio) navigation. Simple modes of operation and the aviation database give the pilot a considerable amount of information about the flight, the terrain and Class B, C and D airspace, and special use airspace. Many pilots use GPS to determine distance from airspace with restrictions and/or communications requirements. When using GPS to avoid airspace, allow for a buffer between the aircraft and the airspace. The aviation database in the GPS may not exactly match the airspace as depicted on the sectional chart. If there is a difference between the sectional chart and GPS information, the sectional chart should be considered the correct information.

A PPC pilot using GPS should ensure that the batteries are fresh and the aviation database is current. Never rely entirely on the GPS for navigation. Always back up GPS by using pilotage with a sectional chart and checkpoints when flying beyond visual range of a familiar airport. In addition, the GPS should be secured in the powered parachute so it does not depart the cart, nor touch the propeller before it stops.



# CHAPTER 9

## GROUND REFERENCE MANEUVERS

### Purpose and Scope

Ground reference maneuvers and their related factors are used in developing a high degree of pilot skill. Although most of these maneuvers are not performed as such in normal everyday flying, the elements and principles involved in each are applicable to performance of the customary pilot operations. They aid the pilot in analyzing the effect of wind and other forces acting on the powered parachute, and in developing a fine control touch and the division of attention necessary for accurate and safe powered parachute maneuvering.

All of the early part of the pilot's training has been conducted for the purpose of developing technique, knowledge of maneuvers, feel, and the handling of the powered parachute in general. This training will have required that most of the pilot's attention be given to the actual handling of the powered parachute, and the results of control pressures on the action of the powered parachute.

If permitted to continue beyond the appropriate training stage, however, the student pilot's concentration of attention will become a fixed habit, one that will seriously detract from the student's ease and safety as a pilot, and will be very difficult to eliminate. Therefore it is necessary, as soon as the pilot shows proficiency in the fundamental maneuvers, that the pilot be introduced to maneuvers requiring outside attention on a practical application of these maneuvers and the knowledge gained.

During ground reference maneuvers, it is important that basic flying technique previously learned be maintained. The flight instructor should not allow any relaxation of the student's previous standard of technique simply because a new factor is added. This requirement should be maintained throughout the student's progress from maneuver to maneuver. Each new maneuver should embody some advance and include the principles of the preceding one in order that continuity is maintained. Each new factor introduced

should be merely a step-up of one already learned so that orderly, consistent progress can be made.

### Maneuvering by Reference to Ground Objects

Ground track or ground reference maneuvers are performed at a relatively low altitude while applying wind drift correction as needed to follow a predetermined track or path over the ground. They are designed to develop the ability to control the powered parachute and to recognize and correct for the effect of wind while dividing attention among other matters. This requires planning ahead of the powered parachute, maintaining orientation in relation to ground objects, flying appropriate headings to follow a desired ground track, and being cognizant of other air traffic in the immediate vicinity.

Pilots should perform clearing turns prior to beginning a maneuver. The essential idea of the clearing turn is to be certain that the next maneuver is not going to proceed into another aircraft's flightpath. Some pilot training programs have hard and fast rules, such as requiring two 90° turns in opposite directions before executing any training maneuver. Other types of clearing procedures may be developed by individual flight instructors. Whatever the preferred method, a clearing procedure should be used. Execute the appropriate clearing procedure before all turns and before executing any training maneuver. Proper clearing procedures, combined with proper visual scanning techniques, are the most effective strategy for collision avoidance.

Ground reference maneuvers should be flown so as not to descend below 200 feet above the ground. The actual altitude will depend on a number of factors. You should plan and fly the maneuver so as not to descend below an altitude of 200 feet above ground level (AGL); however you must also plan and fly so as not to come closer than 500 feet to any person, vessel, vehicle or structure.



- The radius of the turn and the path of the powered parachute over the ground should be easily noted and changes planned and effected as circumstances require.
- Drift should be easily discernable, but not tax the student too much in making corrections.
- The altitude should be low enough to render any gain or loss apparent to the student, but in no case closer than 500 feet to the highest obstruction or lower then 200 feet above the ground.

During these maneuvers, both the instructor and the student should be alert for available forced-landing fields. The area chosen should be away from communities, livestock, or groups of people to prevent possible annoyance or hazards to others. Due to the altitudes at which these maneuvers are performed, there is little time available to search for a suitable field for landing in the event the need arises.

### Drift and Ground Track Control

Whenever any object is free from the ground, it is affected by the medium with which it is surrounded. This means that a free object will continue to move in its current direction and speed unless acted upon by another force. For example, if a powerboat is crossing a river and the river is still, the boat could head directly to a point on the opposite shore and travel on

a straight course to that point without drifting. However, if the river were flowing swiftly, the water current would have to be considered. That is, as the boat progresses forward with its own power, it must also move upstream at the same rate the river is moving it downstream. This is accomplished by angling the boat upstream sufficiently to counteract the downstream flow. If this is done, the boat will follow the desired track across the river from the departure point directly to the intended destination point. Should the boat not be headed sufficiently upstream, it would drift with the current and run aground at some point downstream on the opposite bank. [Figure 9-1]

As soon as a powered parachute becomes airborne, it is free of ground friction. Its path is then affected by the air mass in which it is flying; therefore, the powered parachute (like the boat) will not always track along the ground in the exact direction that it is headed. When flying with the longitudinal axis of the powered parachute aligned with a road, the powered parachute may get closer to or farther from the road without any turn having been made. This would indicate the air mass is moving sideward in relation to the powered parachute. Since the powered parachute is flying within this moving body of air (wind), it moves or drifts with the air in the same direction and speed, just like the boat moved with the river current. [See Figure 9-1]

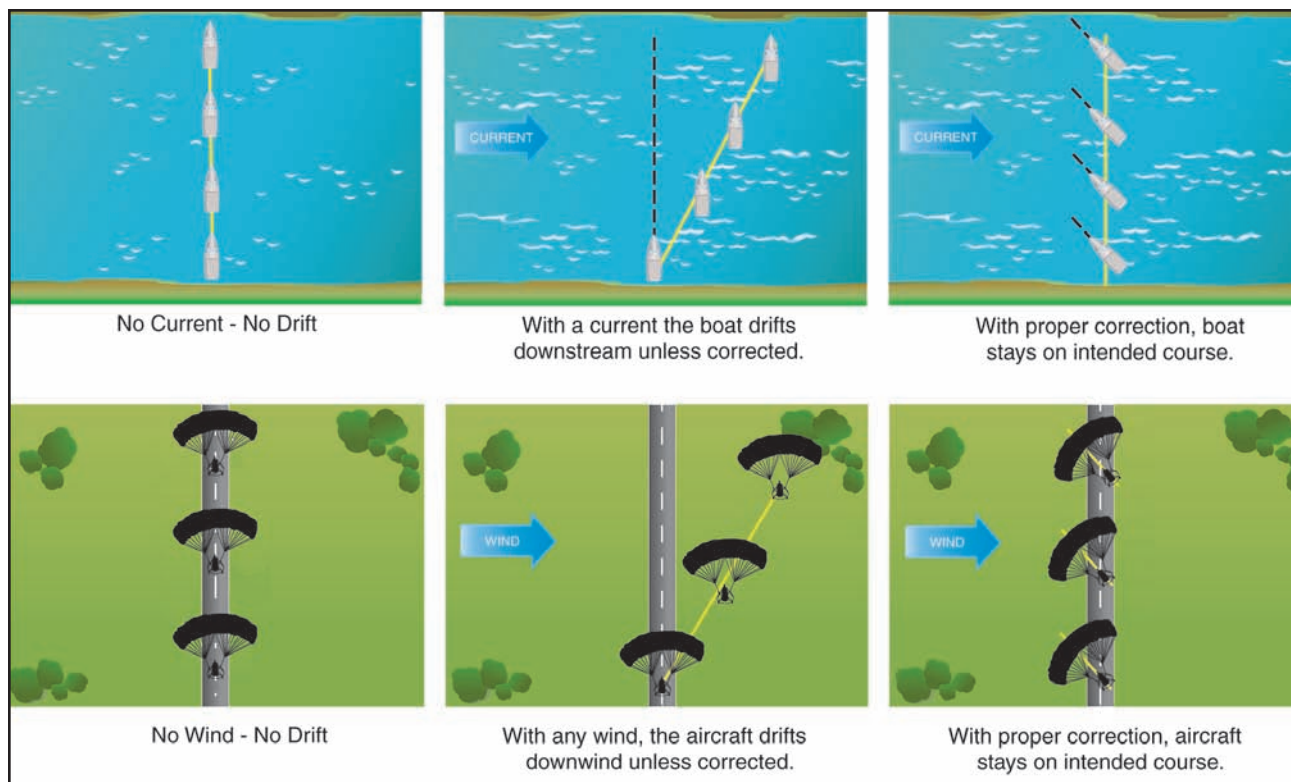

Figure 9-1. Wind drift.

When flying straight and level and following a selected ground track, the preferred method of correcting for wind drift is to head the powered parachute sufficiently into the wind to cause the powered parachute to move forward into the wind at the same rate the wind is moving it sideways. Depending on the wind velocity, this may require a large wind correction angle or one of only a few degrees. When the drift has been neutralized, the powered parachute will follow the desired ground track.

To understand the need for drift correction during flight, consider a flight with a wind velocity of 30 knots from the left and 90° to the direction the powered parachute is headed. After 1 hour, the body of air in which the powered parachute is flying will have moved 30 NM to the right. Since the powered parachute is moving with this body of air, it too will have drifted 30 NM to the right. In relation to the air, the powered parachute moved forward, but in relation to the ground, it moved forward as well as 30 NM to the right.

There are times when the pilot needs to correct for drift while in a turn. [Figure 9-2] Throughout the turn the wind will be acting on the powered parachute from constantly changing angles. The relative wind angle and speed govern the time it takes for the powered parachute to progress through any part of a turn. This is due to the constantly changing groundspeed. When the powered parachute is headed into the wind, the groundspeed is decreased; when headed downwind, the groundspeed is increased. Through the crosswind portion of a turn, the powered parachute must be turned sufficiently into the wind to counteract drift.

To follow a desired circular ground track, the wind correction angle must be varied in a timely manner because of the varying groundspeed as the turn progresses. The faster the groundspeed, the faster the

wind correction angle must be established; the slower the groundspeed, the slower the wind correction angle must be established. You will see then that the PPC should have the steepest bank and fastest rate of turn on the downwind portion of the turn and have the shallowest bank and slowest rate of turn on the upwind portion.

The principles and techniques of varying the angle of bank to change the rate of turn and wind correction angle for controlling wind drift during a turn are the same for all ground track maneuvers involving changes in direction of flight.

When there is no wind, it should be simple to fly along a ground track with an arc of exactly 180° and a constant radius because the flightpath and ground track would be identical. This can be demonstrated by approaching a road at a 90° angle and, when directly over the road, rolling into a medium-banked turn, then maintaining the same angle of bank throughout the 180° of turn. [Figure 9-2]

To complete the turn, the rollout should be started at a point where the canopy will become level as the powered parachute again reaches the road at a 90° angle and will be directly over the road just as the turn is completed. This would be possible only if there were absolutely no wind and if the angle of bank and the rate of turn remained constant throughout the entire maneuver.

If the turn were made with a constant angle of bank and a wind blowing directly across the road, it would result in a constant radius turn through the air. However, the wind effects would cause the ground track to be distorted from a constant radius turn or semicircular path. The greater the wind velocity, the greater would be the difference between the desired ground track and the flightpath. To counteract this drift, the

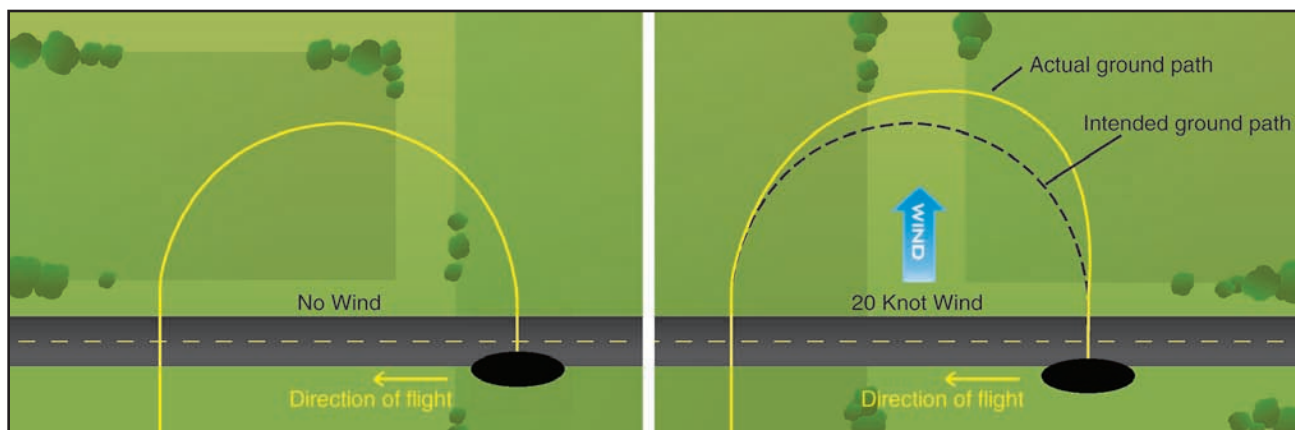
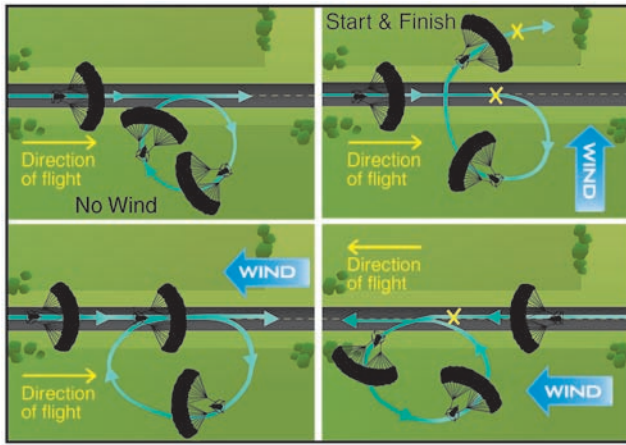

Figure 9-2. Effect of wind during a turn.



**Figure 9-3. Effect of wind during turns.**

flightpath can be controlled by the pilot in such a manner as to neutralize the effect of the wind, and cause the ground track to be a constant radius semicircle.

The effects of wind during turns can be demonstrated after selecting a road, railroad, or other ground reference that forms a straight line parallel to the wind. Fly into the wind directly over and along the line and then make a turn with a constant medium angle of bank for 360° of turn. [Figure 9-3] The powered parachute will return to a point directly over the line but slightly downwind from the starting point, the amount depending on the wind velocity and the time required to complete the turn. The path over the ground will be an elongated circle, although in reference to the air, it is a perfect circle. Straight flight during the upwind segment after completion of the turn is necessary to bring the powered parachute back to the starting position.

A similar 360° turn may be started at a specific point over the reference line, with the powered parachute headed directly downwind. In this demonstration, the effect of wind during the constant banked turn will drift the powered parachute to a point where the line is re-intercepted, but the 360° turn will be completed at a point downwind from the starting point.

Another reference line which lies directly crosswind may be selected and the same procedure repeated, showing that if wind drift is not corrected the powered parachute will, at the completion of the 360° turn, be headed in the original direction but will have drifted away from the line a distance dependent on the amount of wind.

From these demonstrations, you will see where and why it is necessary to increase or decrease the angle of bank and the rate of turn to achieve a desired track over the ground. The principles and techniques in-

olved can be practiced and evaluated by the performance of the ground track maneuvers discussed in this chapter.

## Rectangular Course

Normally, the rectangular course is the first ground reference maneuver the pilot is introduced to. [Figure 9-4]

The rectangular course is a training maneuver in which the ground track of the powered parachute is equidistant from all sides of a selected rectangular area on the ground. The maneuver simulates the conditions encountered in an airport traffic pattern. While performing the maneuver, the altitude should be held constant.

The maneuver assists the student pilot in perfecting:

- Practical application of the turn.
- The division of attention between the flightpath, ground objects, and the handling of the powered parachute.
- The timing of the start of a turn so that the turn will be fully established at a definite point over the ground.
- The timing of the recovery from a turn so that a definite ground track will be maintained.
- The establishing of a ground track and the determination of the appropriate “crab” angle.

Like those of other ground track maneuvers, one of the objectives is to develop division of attention between the flightpath and ground references, while controlling the powered parachute and watching for other aircraft in the vicinity. Another objective is to develop recognition of drift toward or away from a line parallel to the intended ground track. This will be helpful in recognizing drift toward or from an airport runway (landing area) during the various legs of the airport traffic pattern.

For this maneuver, a square or rectangular field, or an area bounded on four sides by section lines or roads, should be selected well away from other air traffic. The powered parachute should be flown parallel to and at a uniform distance from the field boundaries, not necessarily directly above the boundaries. For best results, the flightpath should be positioned outside the field boundaries just far enough that they may be easily observed from either pilot seat by looking out the side of the powered parachute. If an attempt is made to fly directly above the edges of the field, the pilot will have no usable reference points to start and complete the turns. The closer the track of the powered parachute is to the field boundaries, the steeper the

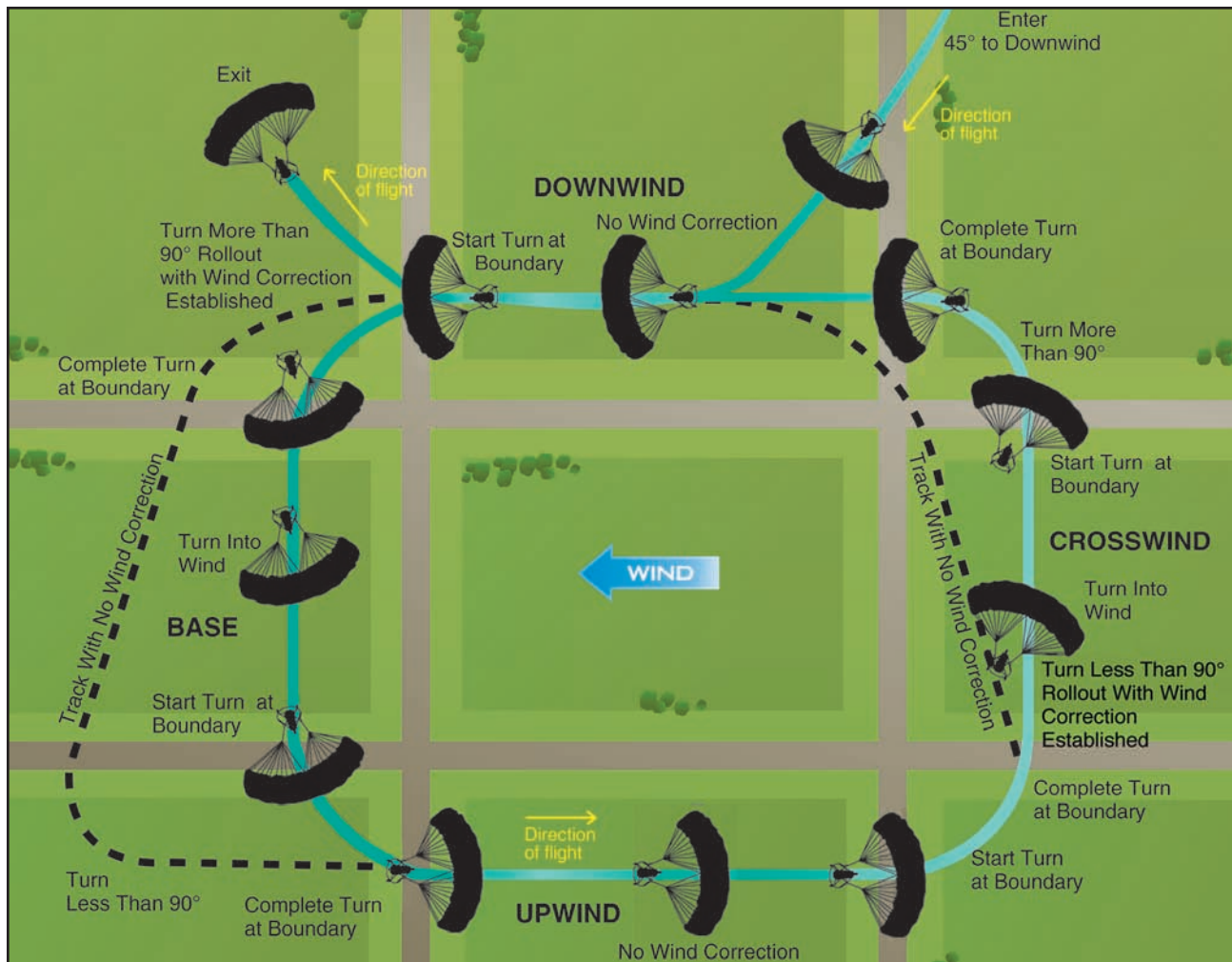

**Figure 9-4. Rectangular course.**

bank necessary at the turning points. Also, the pilot should be able to see the edges of the selected field while seated in a normal position and looking out the side of the powered parachute during either a left-hand or right-hand course. The distance of the ground track from the edges of the field should be the same regardless of whether the course is flown to the left or right. All turns should be started when the powered parachute is abeam the corner of the field boundaries headed downwind where ground reference maneuvers are typically started. These should be the determining factors in establishing the distance from the boundaries for performing the maneuver.

Although the rectangular course may be entered from any direction, this discussion assumes entry on a downwind.

On the downwind leg, the wind is a tailwind and results in an increased groundspeed. Consequently, the turn onto the next leg is entered with a fairly fast rate of turn and a higher (medium) bank. As the turn pro-

gresses, the bank angle is reduced gradually because the tailwind component is diminishing, resulting in a decreasing groundspeed. During and after the turn onto this leg (the equivalent of the base leg in a traffic pattern), the wind will tend to drift the powered parachute away from the field boundary. To compensate for the drift, the amount of turn will be more than 90°.

The rollout from this turn must be such that as the wing becomes level, the powered parachute is turned slightly toward the field and into the wind to correct for drift. The powered parachute should again be the same distance from the field boundary and at the same altitude, as on other legs. The base leg should be continued until the upwind leg boundary is being approached. Once more the pilot should anticipate drift and turning radius. Since drift correction was held on the base leg, it is necessary to turn less than 90° to align the powered parachute parallel to the upwind leg boundary. This turn should be started with a medium bank angle with a gradual reduction to a shallow bank

as the turn progresses. The rollout should be timed to assure paralleling the boundary of the field as the canopy becomes level.

While the powered parachute is on the upwind leg, the next field boundary should be observed as it is being approached, to plan the turn onto the crosswind leg. Since the wind is a headwind on this leg, it is reducing the powered parachute's groundspeed and during the turn onto the crosswind leg will try to drift the powered parachute toward the field. For this reason, the roll-in to the turn must be slow and the bank relatively shallow to counteract this effect. As the turn progresses, the headwind component decreases, allowing the groundspeed to increase. Consequently, the bank angle and rate of turn are increased gradually to assure that upon completion of the turn the crosswind ground track will continue the same distance from the edge of the field. Completion of the turn with the wing level should be accomplished at a point aligned with the upwind corner of the field.

Simultaneously, as the wing is rolled level, the proper drift correction is established with the powered parachute turned into the wind. This requires that the turn be less than a 90° change in heading. If the turn has been made properly, the powered parachute should be the same distance from the field boundary and at the same altitude, as on other legs. While on the crosswind leg, the wind correction angle should be adjusted as necessary to maintain a uniform distance from the field boundary.

As the next field boundary is being approached, the pilot should plan the turn onto the downwind leg. Since a wind correction angle is being held into the wind and away from the field while on the crosswind leg, this next turn will require a turn of more than 90°. Since the crosswind will become a tailwind, causing the groundspeed to increase during this turn, the bank initially should be medium and progressively increased as the turn proceeds. To complete the turn, the rollout must be timed so that the wing becomes level at a point aligned with the crosswind corner of the field just as the longitudinal axis of the powered parachute again becomes parallel to the field boundary. The distance from the field boundary should be the same as from the other sides of the field.

Usually, drift should not be encountered on the upwind or the downwind leg, but it may be difficult to find a situation where the wind is blowing exactly parallel to the field boundaries. This would make it necessary to use a slight wind correction angle on all the legs. It is important to anticipate the turns to cor-

rect for groundspeed, drift, and turning radius. When the wind is behind the powered parachute, the turn must be faster and steeper; when it is ahead of the powered parachute, the turn must be slower and shallower. These same techniques apply while flying in airport traffic patterns.

Common errors in the performance of rectangular courses are:

- Failure to adequately clear the area.
- Failure to establish proper altitude prior to entry. (Typically, entering the maneuver while descending.)
- Failure to establish appropriate wind correction angle resulting in drift.
- Gaining or losing altitude.
- Abrupt control usage.
- Inability to adequately divide attention between powered parachute control, maintaining ground track, and maintaining altitude.
- Improper timing in beginning and recovering from turns.
- Inadequate visual lookout for other aircraft.

## S-Turns Across a Road

An S-turn across a road is a practice maneuver in which the powered parachute's ground track describes semicircles of equal radii on each side of a selected straight line on the ground. [Figure 9-5] The straight line may be a road, fence, railroad, or section line that lies perpendicular to the wind, and should be of sufficient length for making a series of turns. A constant altitude should be maintained throughout the maneuver; do not go lower than 200 feet.

S-turns across a road present one of the most elementary problems in the practical application of the turn and in the correction for wind drift in turns. The application of this maneuver is considerably less advanced in some respects than the rectangular course. However it is taught after the student has been introduced to the rectangular course in order that he or she may have a knowledge of the correction for wind drift in straight flight along a reference line, before attempting to correct for drift by applying a turn.

The objectives of S-turns across a road are to develop the ability to compensate for drift during turns, orient the flightpath with ground references, follow an assigned ground track, arrive at specified points on assigned headings, and divide the pilot's attention. The maneuver consists of crossing the road at a 90° angle and immediately beginning a series of 180° turns of uniform radius in opposite directions, re-crossing the road at a 90° angle just as each 180° turn is completed.

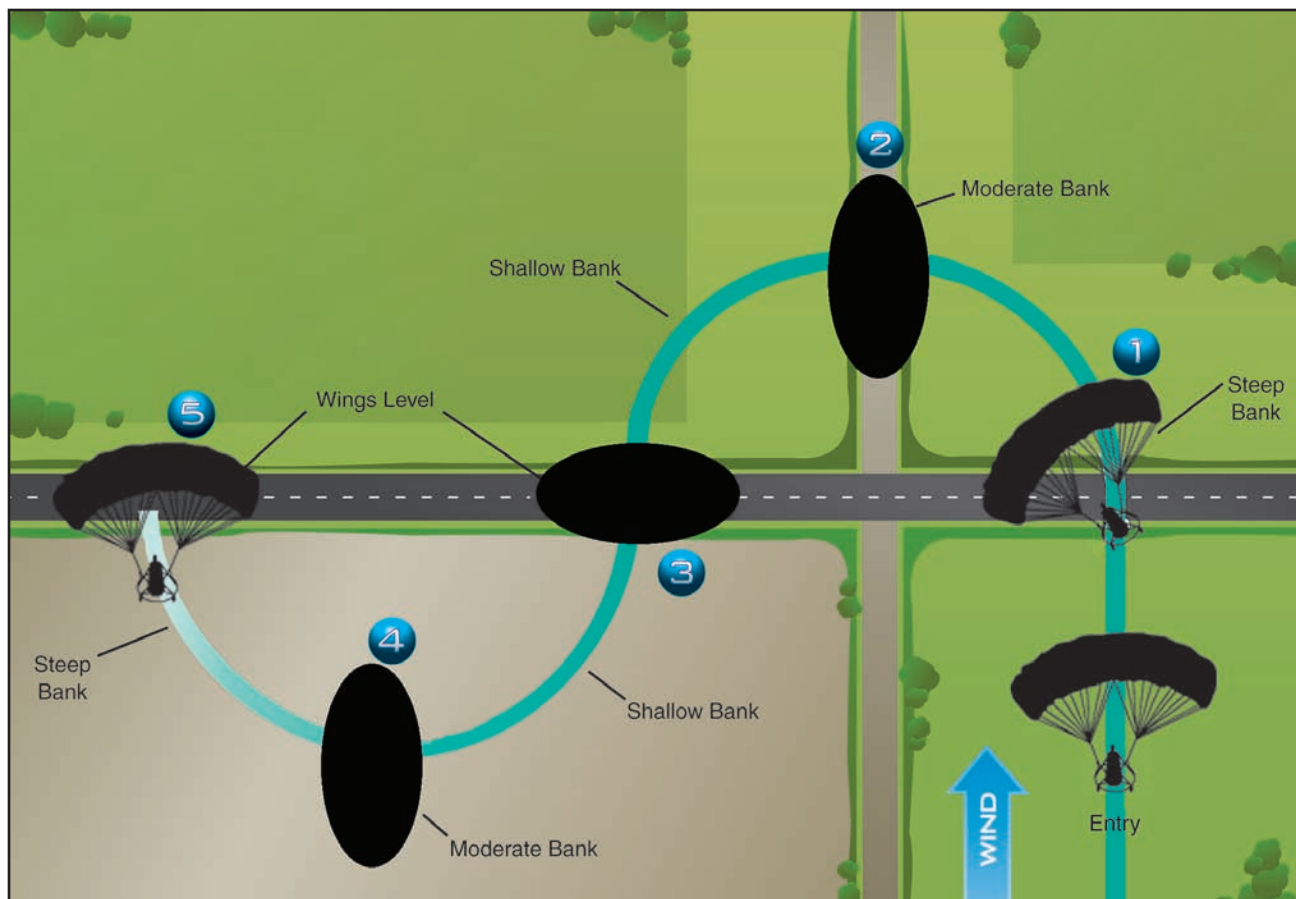

**Figure 9-5. S-turns.**

To accomplish a constant radius ground track requires a changing rate of turn and angle of bank to establish the wind correction angle. Both will increase or decrease as groundspeed increases or decreases.

The bank must be steepest when beginning the turn on the downwind side of the road and must be shallowed gradually as the turn progresses from a downwind heading to an upwind heading. On the upwind side, the turn should be started with a relatively shallow bank and then gradually steepened as the powered parachute turns from an upwind heading to a downwind heading. In this maneuver, the powered parachute should be rolled from one bank directly into the opposite just as the reference line on the ground is crossed.

Before starting the maneuver, a straight ground reference line or road that lies 90° to the direction of the wind should be selected, then the area should be checked to ensure that no obstructions or other aircraft are in the immediate vicinity. The road should be approached from the upwind side, at the selected altitude on a downwind heading. When directly over the road, start the first turn immediately. With the pow-

ered parachute headed downwind, the groundspeed is greatest and the rate of departure from the road will be rapid; so the roll into the bank must be fairly rapid to attain the proper wind correction angle. This prevents the powered parachute from flying too far from the road and from establishing a ground track of excessive radius. During the latter portion of the first 90° of turn when the powered parachute's heading is changing from a downwind heading to a crosswind heading, the groundspeed becomes less and the rate of departure from the road decreases. The wind correction angle will be at the maximum when the powered parachute is headed directly crosswind.

After turning 90°, the powered parachute's heading becomes more and more an upwind heading, the groundspeed will decrease, and the rate of closure with the road will become slower. If a constant steeper bank were maintained, the powered parachute would turn too quickly for the slower rate of closure, and would be headed perpendicular to the road prematurely. Because of the decreasing groundspeed and rate of closure while approaching the upwind heading, it will be necessary to gradually shallow the bank during the remaining 90° of the semicircle, so that the

wind correction angle is removed completely and the wing becomes level as the 180° turn is completed at the moment the road is reached.

At the instant the road is being crossed again, a turn in the opposite direction should be started. Since the powered parachute is still flying into the headwind, the groundspeed is relatively slow. Therefore, the turn will have to be started with a shallow bank so as to avoid an excessive rate of turn that would establish the maximum wind correction angle too soon. The degree of bank should be that which is necessary to attain the proper wind correction angle so the ground track describes an arc the same size as the one established on the downwind side.

Since the powered parachute is turning from an upwind to a downwind heading, the groundspeed will increase and after turning 90°, the rate of closure with the road will increase rapidly. Consequently, the angle of bank and rate of turn must be progressively increased so that the powered parachute will have turned 180° at the time it reaches the road. Again, the rollout must be timed so the powered parachute is in straight-and-level flight directly over and perpendicular to the road.

Throughout the maneuver a constant altitude should be maintained, and the bank should be changing constantly to affect a true semicircular ground track.

Often there is a tendency to increase the bank too rapidly during the initial part of the turn on the upwind side, which will prevent the completion of the 180° turn before re-crossing the road. This is apparent when the turn is not completed in time for the powered parachute to cross the road at a perpendicular angle. To avoid this error, the pilot must visualize the desired half circle ground track, and increase the bank during the early part of this turn. During the latter part of the turn, when approaching the road, the pilot must judge the closure rate properly and increase the bank accordingly, so as to cross the road perpendicular to it just as the rollout is completed.

Common errors in the performance of S-turns across a road are:

- Failure to adequately clear the area.
- Gaining or losing altitude.
- Inability to visualize the half circle ground track.
- Poor timing in beginning and recovering from turns.
- Faulty correction for drift.
- Inadequate visual lookout for other aircraft.

## Turns Around a Point

As a training maneuver turns around a point is a logical extension of the principles involved in the performance of S-turns across a road. Its purposes as a training maneuver are:

- To further perfect turning technique.
- To perfect the ability to subconsciously control the powered parachute while dividing attention between the flightpath and ground references.
- To teach the student that the radius of a turn is a distance which is affected by the degree of bank used when turning with relation to a definite object.
- To develop a keen perception of altitude.
- To perfect the ability to correct for wind drift while in turns.

In turns around a point, the powered parachute is flown in a complete circle of uniform radii or distance from a prominent ground reference point while maintaining a constant altitude; do not go lower than 200 feet.

The factors and principles of drift correction that are involved in S-turns are also applicable in this maneuver. As in other ground track maneuvers, a constant radius around a point will, if any wind exists, require a constantly changing angle of bank and wind correction angles. The closer the powered parachute is to a direct downwind heading where the groundspeed is greatest, the steeper the bank and the faster the rate of turn required to establish the proper wind correction angle. The more nearly it is to a direct upwind heading where the groundspeed is least, the shallower the bank and the slower the rate of turn required to establish the proper wind correction angle. It follows, then, that throughout the maneuver the bank and rate of turn must be gradually varied in proportion to the groundspeed.

The point selected for turns around a point should be prominent, easily distinguished by the pilot, and yet small enough to present precise reference. [Figure 9-6] Isolated trees, crossroads, or other similar small landmarks are usually suitable.

To enter turns around a point, the powered parachute should be flown on a downwind heading to one side of the selected point at a distance equal to the desired radius of turn.

When any significant wind exists, it will be necessary to roll into the initial bank at a rapid rate so that the steepest bank is attained abeam of the point when the

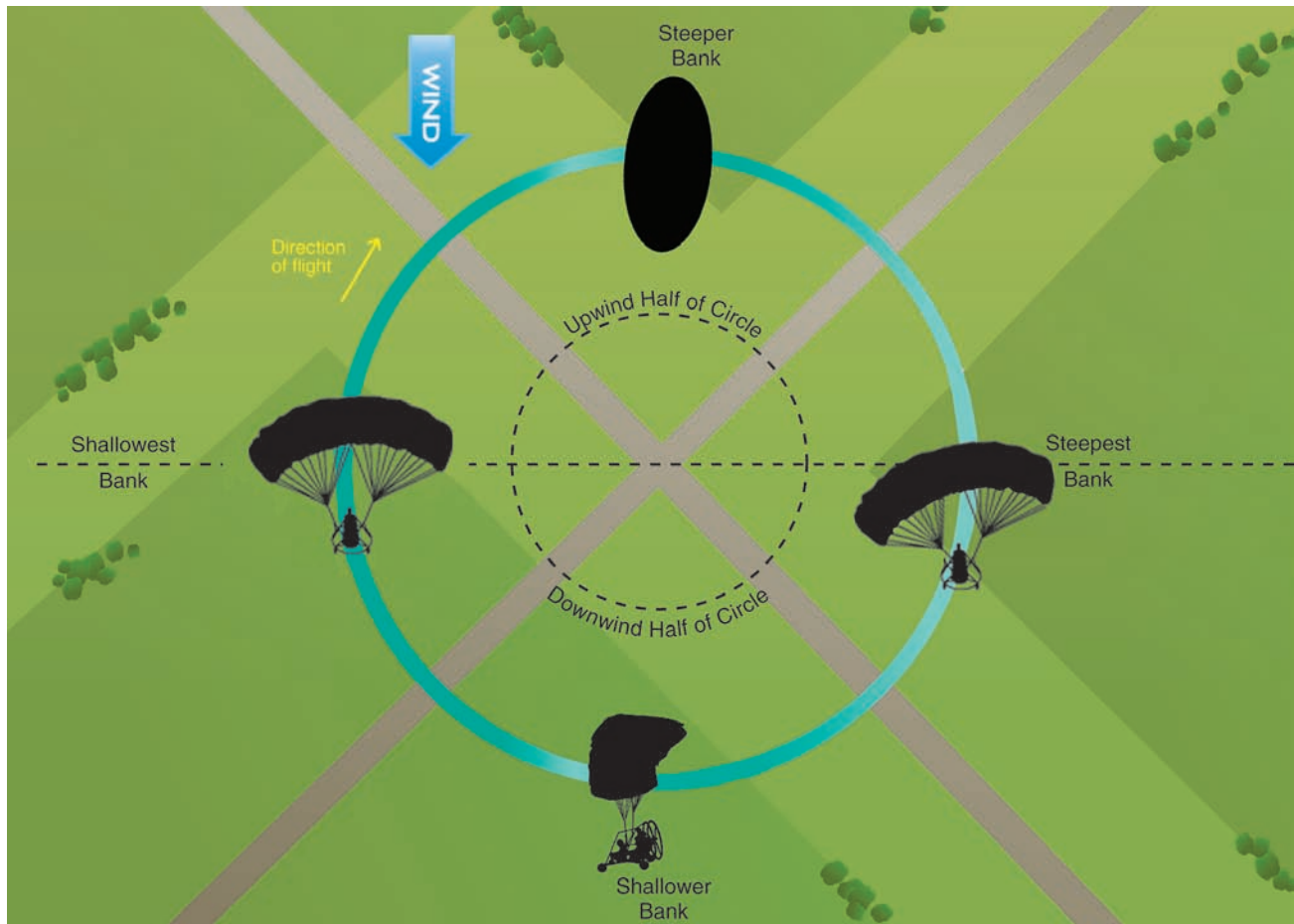

**Figure 9-6. Turns around a point.**

powered parachute is headed directly downwind. By entering the maneuver while heading directly downwind, the steepest bank can be attained immediately. Thereafter, the bank is shallowed gradually until the point is reached where the powered parachute is headed directly upwind. At this point, the bank should be gradually steepened until the steepest bank is again attained when heading downwind at the initial point of entry.

Just as S-turns require that the powered parachute be turned into the wind in addition to varying the bank, so do turns around a point. During the downwind half of the circle, the powered parachute's nose is progressively turned toward the inside of the circle; during the upwind half, the nose is progressively turned toward the outside. The downwind half of the turn around the point may be compared to the downwind side of the S-turn across a road; the upwind half of the turn around a point may be compared to the upwind side of the S-turn across a road.

As the pilot becomes experienced in performing turns around a point and has a good understanding of the effects of wind drift and varying of the bank angle and wind correction angle as required, entry into the

maneuver may be from any point. When entering the maneuver at a point other than downwind, however, the radius of the turn should be carefully selected, taking into account the wind velocity and groundspeed so that an excessive bank is not required later on to maintain the proper ground track. The flight instructor should place particular emphasis on the effect of an incorrect initial bank.

Common errors in the performance of turns around a point are:

- Failure to adequately clear the area.
- Failure to establish appropriate bank on entry.
- Failure to recognize wind drift.
- Excessive bank and/or inadequate wind correction angle on the downwind side of the circle resulting in drift towards the reference point.
- Inadequate bank angle and/or excessive wind correction angle on the upwind side of the circle resulting in drift away from the reference point.
- Gaining or losing altitude.
- Inadequate visual lookout for other aircraft.
- Inability to direct attention outside the powered parachute while maintaining precise powered parachute control.





# CHAPTER 10



## AIRPORT TRAFFIC PATTERNS

It is very important to note 14 CFR part 91 requires powered parachutes to avoid the flow of fixed-wing aircraft. Additional information on airport operations can be found in the *Aeronautical Information Manual* (AIM) and the *Pilot's Handbook of Aeronautical Knowledge*.

### Airport Traffic Patterns and Operations

Every flight begins and ends at an airport; an airport, as defined by the Federal Aviation Regulations, is an area of land or water that is used or intended to be used for the landing and takeoff of aircraft. For this reason, it is essential you learn the traffic rules, procedures, and patterns that may be in use at various airports.

Most aviation accidents occur within a few miles of the airport. This is where congestion is the heaviest and the pilot is the busiest.

“See and avoid” is critical for safe operations. Advisories on the common traffic advisory frequency (CTAF) are essential at nontower-controlled airports and flying fields to advise other aircraft of your position and intentions.

To enhance safety around airports, specific traffic patterns and traffic control procedures have been established at airports. The traffic patterns provide specific routes for takeoffs, departures, arrivals, and landings. The exact nature of each airport traffic pattern is dependent on the runway in use, wind conditions, obstructions, and other factors.

Different traffic patterns at the same airport may be established for heavy aircraft, general aviation aircraft, gliders and light-sport aircraft (LSA) operations. The largest factor in determining the proper traffic pattern is airspeed. Slow aircraft do not mix well with fast aircraft. The powered parachute is at the slow end of the speed range of aircraft found around most airports. Regardless of the traffic pattern flown, you must be

aware of your position relative to other aircraft in the traffic pattern and avoid the flow of fixed-wing aircraft. Helicopters fall under this same rule. This rule frequently affects the choice for a landing site. Refer to Chapter 5 for more information on selecting a landing site and airport operation information.

With that in mind, you must understand the standard airport traffic pattern in use at the airport you are operating at and the traffic pattern you are flying to maintain separation from other aircraft traffic.

Powered parachutes operate best from a grass surface, due to less wear and tear on the canopy. However, off-runway operation may disrupt normal airport operations and may not be safe for the PPC due to poor surface conditions. If an off-runway area is used for PPC operations, examine the area for surface condition, holes, standing water, rocks, vegetation height, moguls, fences, wires and other hazards.

A traffic pattern may be established for an off-runway operating area. The traffic pattern may not, and probably will not, conform to the airplane traffic pattern. It is still your responsibility to avoid the flow of airplane traffic.

If you elect to use the airport runway, take into consideration any crosswind that may be present. The airport runway may not be aligned close enough into the wind for your flying skills or may exceed the canopy limitations.

The established powered parachute traffic pattern for an airport might be similar to the standard traffic pattern or it might use turns in the opposite direction. [Figure 10-1] In both cases, use a standard rectangular pattern with a pattern altitude one-half the airplane traffic pattern altitude or as published (if published). An airport may also use a smaller pattern, referred to as a “tight pattern” or “inside pattern,” and it might be in the same direction as the other traffic or opposite. This smaller pattern combined with a pattern altitude of one-half the airport traffic pattern helps ensure sep-

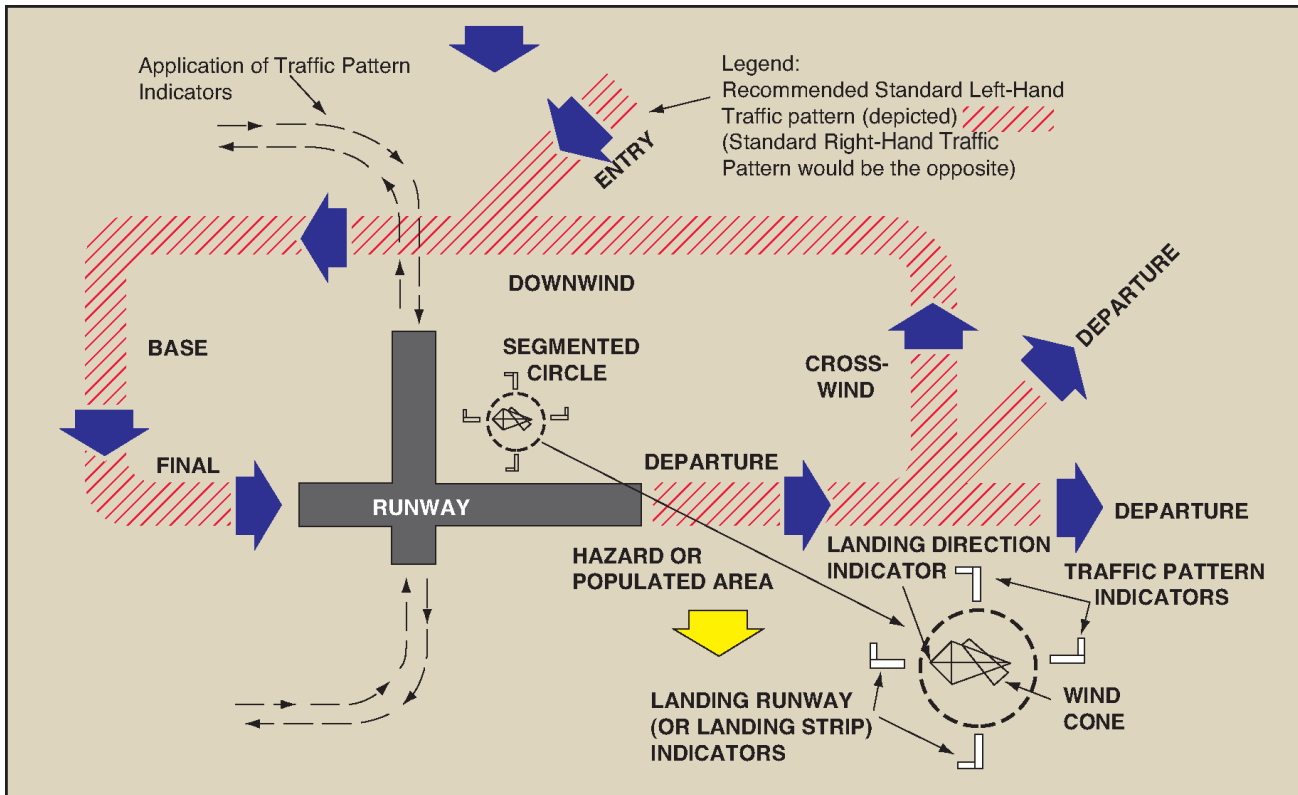

**Figure 10-1. Traffic patterns.**

ation from aircraft flying much faster. It is important to review the Airport/Facilities Directory (A/FD) and understand the procedures used at each airport you will be operating at.

Airports vary in complexity from small, private grass or sod strips to public major terminals having many paved runways and taxiways. Regardless of the type of airport or field, you must know and abide by the rules and general operating procedures applicable to the airport being used. These rules and procedures are based not only on logic or common sense, but also on courtesy. The objective is to keep air traffic moving with maximum safety and efficiency. The use of any traffic pattern, service, or procedure does not alter the responsibility for you to see and avoid other aircraft.

Control towers and radar facilities provide a means of adjusting the flow of arriving and departing aircraft, and render assistance to pilots in busy terminal areas. You must be familiar with the communication requirements for operating at airports where you operate or intend to operate. [Figure 10-2]

Airport lighting, markings, and signs are used frequently to alert pilots to abnormal conditions and

hazards, provide directions, and assist pilots in airport operations. It is essential you understand and adhere to the information provided by these indicators. [Figures 10-3 and 10-4]

**Standard Airport Traffic Patterns**

The regulations require powered parachutes avoid the flow of fixed-wing aircraft. This rule should be the primary factor in deciding whether a standard airport traffic pattern is appropriate for your operation.

To assure that air traffic flows into and out of an airport in an orderly manner, an airport traffic pattern is established appropriate to the local conditions, including the direction and placement of the pattern, the altitude to be flown, and the procedures for entering and leaving the pattern. Unless the airport displays approved visual markings indicating that turns should be made to the right, you should make all turns in the pattern to the left. Again, the airport may have established a different pattern and altitude for LSA operations; be sure to talk with the airport manager and check the A/FD before heading to the airport.

When operating at an airport with an operating control tower, you will receive by radio a clearance to approach or depart, as well as pertinent information

			Communication/Broadcast Procedures		
	Facility at Airport	Frequency Use	Outbound	Inbound	Practice Instrument Approach
1.	UNICOM (No Tower or FSS)	Communicate with UNICOM station on published CTAF frequency (122.7; 122.8; 122.725; 122.975; or 123.0). If unable to contact UNICOM station, use self-announce procedures on CTAF.	Before taxiing and before taxiing on the runway for departure.	10 miles out. Entering downwind, base, and final. Leaving the runway.	
2.	No Tower, FSS, or UNICOM	Self-announce on MULTICOM frequency 122.9.	Before taxiing and before taxiing on the runway for departure.	10 miles out. Entering downwind, base, and final. Leaving the runway.	Departing final approach fix (name) or on final approach segment inbound.
3.	No Tower in operation, FSS open	Communicate with FSS on CTAF frequency.	Before taxiing and before taxiing on the runway for departure.	10 miles out. Entering downwind, base, and final. Leaving the runway.	Approach completed / terminated.
4.	FSS Closed (No Tower)	Self-announce on CTAF.	Before taxiing and before taxiing on the runway for departure.	10 miles out. Entering downwind, base, and final. Leaving the runway.	
5.	Tower or FSS not in operation	Self-announce on CTAF.	Before taxiing and before taxiing on the runway for departure.	10 miles out. Entering downwind, base, and final. Leaving the runway.	

**Figure 10-2. Recommended communication procedures at uncontrolled airports.**

about the traffic pattern. If there is not a control tower, it is your responsibility to determine the direction of the traffic pattern, to comply with the appropriate traffic rules, and to display common courtesy toward other pilots operating in the area. The common traffic advisory frequency (CTAF) is a good place to listen for traffic at the airport. It is also important to listen to the automatic terminal information service (ATIS) if one is provided.

You are not expected to have extensive knowledge of all traffic patterns at all airports, but if you are familiar with the basic rectangular pattern, it will be easy to make proper approaches and departures from most airports, regardless of whether they have control towers. Check the Airport/Facility Directory for airport and traffic pattern information.

At airports with operating control towers, the tower operator may instruct you to enter the traffic pattern at any point or to make a straight-in approach without flying the usual rectangular pattern. Many other deviations are possible if the tower operator and the pilot work together in an effort to keep traffic moving

smoothly. Jets or heavy aircraft will frequently be flying wider and/or higher patterns than lighter aircraft, and in many cases will make a straight-in approach for landing.

The standard general aviation (GA) rectangular traffic pattern is illustrated in Figure 10-1. Traffic pattern altitude can vary by airport and should be checked in the Airport/Facility Directory. The GA pattern altitude is typically 800 – 1,000 feet. The PPC should NOT be flown at the GA pattern altitude. In an effort to avoid airplanes, the PPC pattern altitude should be one-half the GA pattern altitude. Even after the airplane has slowed to traffic pattern speed, it is still 2 to 3 times the PPC speed.

When entering the traffic pattern at an airport without an operating control tower, inbound pilots are expected to observe other aircraft already in the pattern and to conform to the traffic pattern in use. If other aircraft are not in the pattern, then traffic indicators on the ground and wind indicators must be checked to determine which runway and traffic pattern direction should be used. Many airports have L-shaped traffic

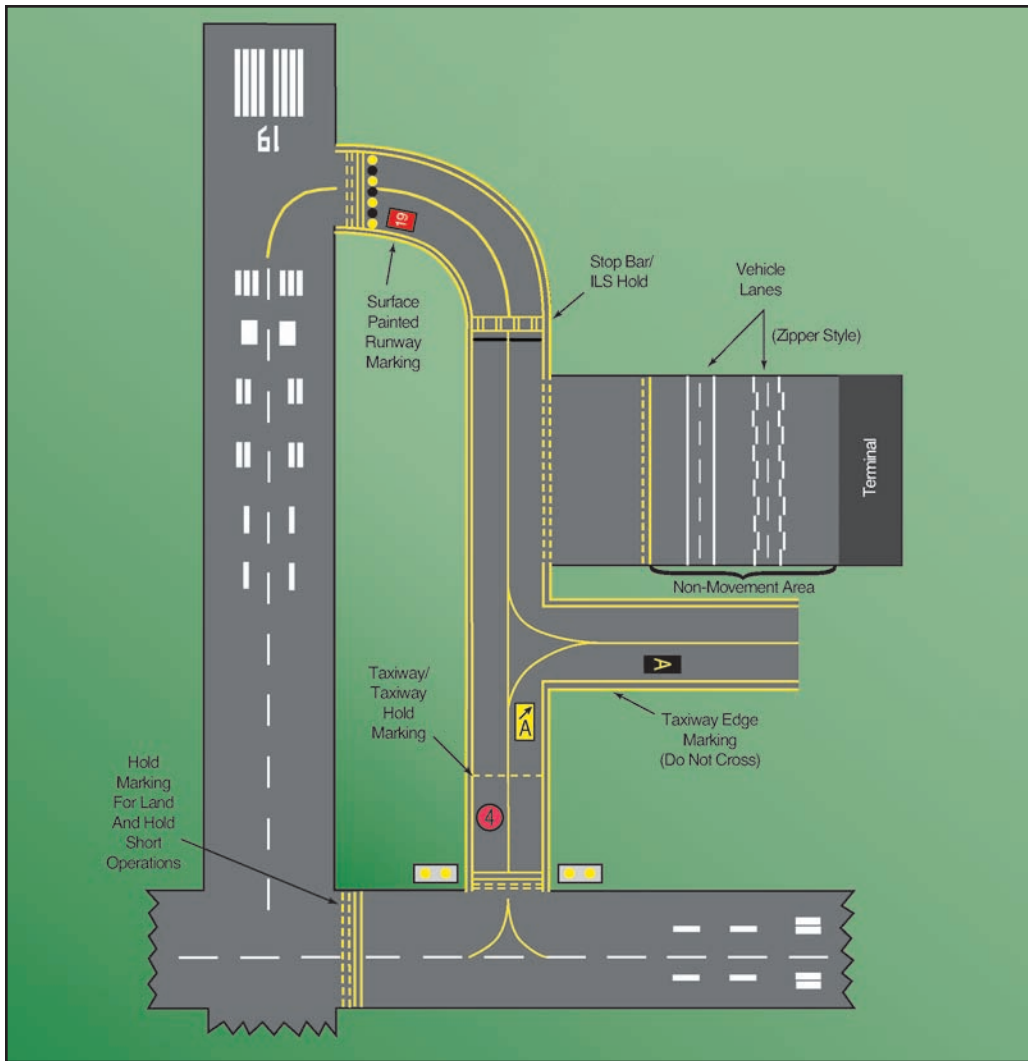

**Figure 10-3. Selected airport markings.**











pattern indicators displayed with a segmented circle adjacent to the runway. [Figure 10-5] The short member of the L shows the direction in which the traffic pattern turns should be made when using the runway parallel to the long member. Check these indicators while at a distance well away from any pattern that might be in use, or while at a safe height well above airport pattern altitudes. Once the proper traffic pattern direction has been determined, you should then proceed to a point well clear of the pattern before descending to the pattern altitude.

When approaching an airport for landing, the traffic pattern should be entered at a 45° angle to the downwind leg, headed toward a point abeam of the mid-point of the runway to be used for landing. Arriving aircraft should be at the proper traffic pattern altitude before entering the pattern, and should stay clear of the traffic flow until established on the entry leg. En-

tries into traffic patterns while descending create specific collision hazards and should always be avoided.

The entry leg should be of sufficient length to provide a clear view of the entire traffic pattern, and to allow you adequate time for planning the intended path in the pattern and the landing approach.

The downwind leg is a course flown parallel to the landing runway, but in a direction opposite to the intended landing direction. This leg should be at one-half the specified traffic pattern altitude to alleviate conflicts with faster aircraft. During this leg, the before landing check should be completed. Maintain pattern altitude until abeam the approach end of the landing runway. At this point, reduce power and begin a descent. The downwind leg continues past a point abeam the approach end of the runway to a point approximately 45° from the approach end of the runway, and a medium bank turn is made onto the base leg.

<b>AIRPORT SIGN SYSTEMS</b>	
<i>TYPE OF SIGN AND ACTION OR PURPOSE</i>	<i>TYPE OF SIGN AND ACTION OR PURPOSE</i>
<b>4-22</b> Taxiway/Runway Hold Position: Hold short of runway on taxiway	 Runway Safety Area/Obstacle Free Zone Boundary: Exit boundary of runway protected areas
<b>26-8</b> Runway/Runway Hold Position: Hold short of intersecting runway	 ILS Critical Area Boundary: Exit boundary of ILS critical area
<b>8-APCH</b> Runway Approach Hold Position: Hold short of aircraft on approach	 Taxiway Direction: Defines direction & designation of intersecting taxiway(s)
<b>ILS</b> ILS Critical Area Hold Position: Hold short of ILS approach critical area	 Runway Exit: Defines direction & designation of exit taxiway from runway
 No Entry: Identifies paved areas where aircraft entry is prohibited	<b>22</b> ↑ Outbound Destination: Defines directions to takeoff runways
 Taxiway Location: Identifies taxiway on which aircraft is located	 Inbound Destination: Defines directions for arriving aircraft
 Runway Location: Identifies runway on which aircraft is located	 Taxiway Ending Marker: Indicates taxiway does not continue
<b>4</b> Runway Distance Remaining: Provides remaining runway length in 1,000 foot increments	 Direction Sign Array: Identifies location in conjunction with multiple intersecting taxiways

**Figure 10-4. Airport signs.**

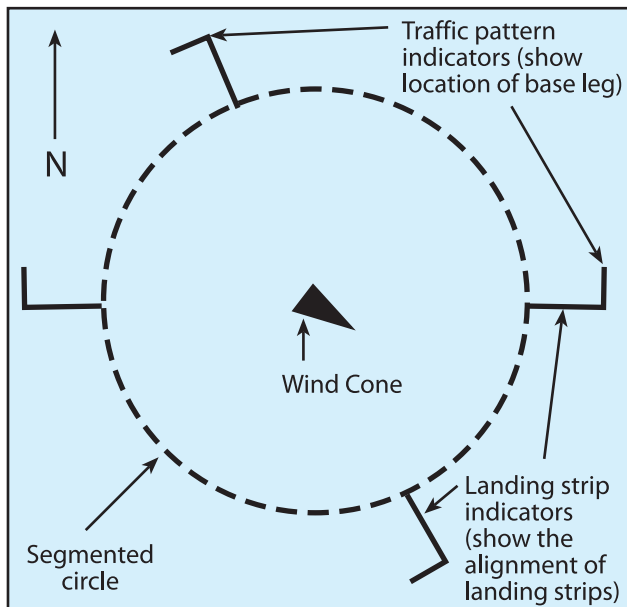

**Figure 10-5. Segmented circle and components.**

The base leg is the transitional part of the traffic pattern between the downwind leg and the final approach leg. Depending on the wind condition, it is established at a sufficient distance from the approach end of the landing runway to permit a gradual descent to the intended touchdown point. The ground track of the powered parachute while on the base leg should be perpendicular to the extended centerline of the landing runway,

although the longitudinal axis of the powered parachute may not be aligned with the ground track when it is necessary to turn into the wind to counteract drift. While on the base leg, the pilot must ensure, before turning onto the final approach, that there is no danger of colliding with another aircraft that may already be on the final approach.

The final approach leg is a descending flightpath starting from the completion of the base-to-final turn and extending to the point of touchdown. This is probably the most important leg of the entire pattern, because here the pilot's judgment and procedures must be the sharpest to accurately control the airspeed and descent angle while approaching the intended touchdown point.

As stipulated in 14 CFR part 91, section 91.113, aircraft while on final approach to land or while landing have the right-of-way over other aircraft in flight or operating on the surface. When two or more aircraft are approaching an airport for the purpose of landing, the aircraft at the lower altitude has the right-of-way. Pilots should not take advantage of this rule to cut in front of another aircraft that is on final approach to land, or to overtake that aircraft.

The upwind leg is a course flown parallel and in the same direction to the landing runway. The upwind leg

continues past a point abeam the departure end of the runway where a medium bank 90° turn is made onto the crosswind leg.

The upwind leg is also the transitional part of the traffic pattern: the final approach, when a go-around is initiated, and where climb attitude is established after lift-off. When a safe altitude is attained, the pilot should commence a shallow bank turn to the crosswind leg of the airport. The go-around is flown much as you would overtake an aircraft by passing the overtaken aircraft on their right. This will allow better visibility of the runway for departing aircraft.

The departure leg of the rectangular pattern is a straight course aligned with, and leading from, the takeoff runway. This leg begins at the point the powered parachute leaves the ground and continues until the 90° turn onto the crosswind leg is started.

On the departure leg after takeoff, continue climbing straight ahead, and, if remaining in the traffic pattern, commence a turn to the crosswind leg. The published airport traffic pattern may describe the turn to crosswind by altitude or ground reference. Begin the turn to crosswind after a positive rate of climb has been established and sufficient altitude has been gained to allow clearance from ground obstructions.

If departing the traffic pattern, continue straight out or exit with a 45° turn, to enter the upwind leg after a positive rate of climb has been established and sufficient altitude has been gained to allow clearance from ground obstructions. Exit the upwind leg straight out. Turning into the upwind leg allows the PPC to exit the pattern and avoid airplanes in the traffic pattern. Care should be taken not to turn into the path of an aircraft in the upwind leg.

If parallel operations are in place (i.e., airplanes on the hard surface, powered parachutes on the grass), fly a pattern that stays within the pattern of the airplane traffic and does not cross the airplanes' active runway. In all cases, the powered parachute should not make any turns until the pilot is certain it will not obstruct any aircraft operating in either pattern.

The crosswind leg is the part of the rectangular pattern that is horizontally perpendicular to the extended centerline of the takeoff runway and is entered by making approximately a 90° turn from the upwind leg. On the crosswind leg, the powered parachute proceeds to the downwind leg position.

Since takeoffs are usually made into the wind, the wind will now be approximately perpendicular to the powered parachute's flightpath. As a result, the powered parachute will have to be turned or headed slightly into the wind while on the crosswind leg to maintain a ground track that is perpendicular to the runway centerline extension.

# CHAPTER 11



## APPROACHES AND LANDINGS

The information in this chapter is specific to the powered parachute land class. Refer to the *Seaplane, Skiplane, and Float/Ski Equipped Helicopter Operations Handbook* (FAA-8083-23) for information regarding operation of a powered parachute category sea class (PPCS) aircraft, as appropriate.

### Normal Approach and Landing

A normal approach and landing involves the use of procedures for what is considered a normal situation; that is, when engine power is available, the wind is light or the final approach is made directly into the wind, the final approach path has no obstacles, and the landing surface is firm, level and of ample length to gradually bring the powered parachute to a stop. The selected landing point should be beyond the runway's approach threshold but within the first one-third portion of the landing area.

So you may better understand the factors that will influence judgment and procedures, the last part of the approach pattern and the actual landing will be divided into five phases: the base leg, the final approach, the roundout, the touchdown, and the after-landing roll.

The manufacturer's recommended procedures, including powered parachute configuration, center of gravity, and other information relevant to approaches and landings in a specific make and model powered parachute are contained in the *Pilot's Operating Handbook* (POH) for that powered parachute. If any of the information in this chapter differs from the powered parachute manufacturer's recommendations as contained in the POH, the powered parachute manufacturer's recommendations take precedence.

### Base Leg

The placement of the base leg is one of the more important judgments made by the pilot in any landing approach. [Figure 11-1] You must accurately judge the altitude and distance from which a gradual descent

will result in landing at the desired spot. The distance will depend on the altitude of the base leg and the effect of wind. When there is a strong wind on final approach, the base leg must be positioned closer to the approach end of the runway than would be required with a light wind. You should strive to fly a constant ground track on base leg.

Drift correction should be established and maintained to follow a ground track perpendicular to the extension of the centerline of the runway on which the landing is to be made. Since the final approach and landing will normally be made into the wind, there may be somewhat of a crosswind during the base leg. This requires the powered parachute be angled sufficiently into the wind to prevent drifting farther away from the intended landing spot.

The base leg should be continued to the point where a medium to shallow-banked turn will align the powered parachute's path directly with the centerline of the landing runway. This descending turn should be completed at a safe altitude that will be dependent upon the height of the terrain and any obstructions along the ground track. The turn to the final approach should also be sufficiently above the airport elevation to permit a final approach long enough for you to accurately estimate the resultant point of touchdown. This will require careful planning as to the starting point and the radius of the turn. Normally, it is recommended that the angle of bank not exceed a medium bank because the steeper the angle of bank, the faster the powered parachute descends. Since the base-to-final turn is often made at a relatively low altitude, it is important not to do radical turns at low altitude. If a significant bank is needed to prevent overshooting the proper final approach path, it is advisable to discontinue the approach, go around, and start the turn earlier on the next approach rather than risk a hazardous situation.



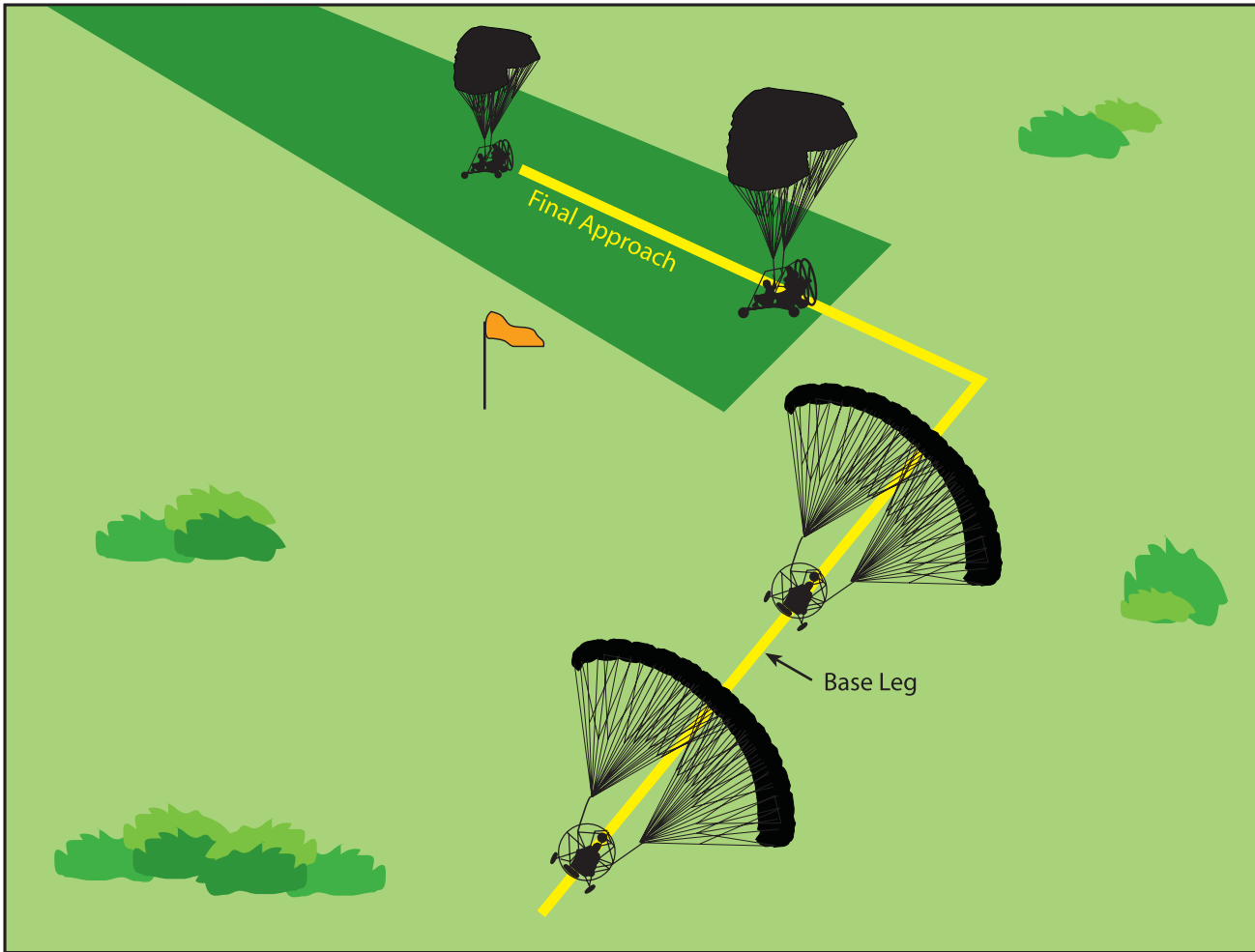

Figure 11-1. Base leg and final approach.

## Final Approach

After the base-to-final approach turn is completed, the powered parachute should be aligned with the centerline of the runway or landing surface, so drift (if any) will be recognized immediately. On a normal approach, with no wind drift, keep the longitudinal axis aligned with the runway centerline throughout the approach and landing. (The proper way to correct for a crosswind will be explained under the section, “Crosswind Approach and Landing.” For now, only an approach and landing where the wind is straight down the landing area will be discussed.)

Focus directly down the centerline and steer right or left to remain on that centerline.

While aligning the powered parachute down the runway centerline, or straight down your intended landing area, slight adjustments in power may be necessary to maintain the descent.

Control the descent angle throughout the approach so the powered parachute will land in the center of the first third of the runway. The descent angle is affected by the throttle. More throttle means lower descent rate, less throttle results in a higher descent rate. The wind also plays a prominent part in the gliding distance over the ground. [Figure 11-2] Naturally, you do not have control over the wind but may correct for its effect on the powered parachute’s descent by appropriate power adjustments: more throttle is required in a headwind and crosswind, less throttle is required with a tailwind.

The objective of a good final approach is to descend at an angle that will permit the powered parachute to reach the desired touchdown point. Since on a normal approach the power setting is not fixed as in a power-off approach, adjust the power as necessary, to control the descent angle, or to attain the desired altitudes along the approach path. This is one reason for performing approaches with partial power; if the approach is too high, merely reduce the power. When the approach is too low, add power.

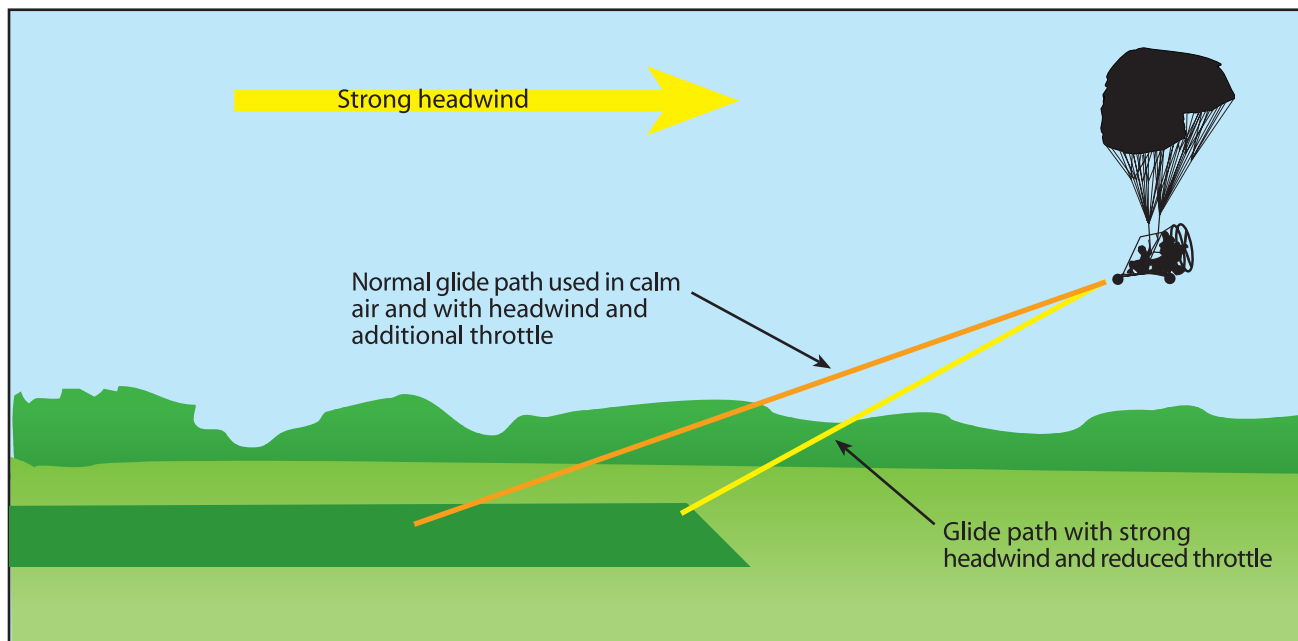

**Figure 11-2. Effect of headwind on final approach.**

## Estimating Height and Movement

During the approach, roundout, and touchdown, vision is of prime importance. To provide a wide scope of vision and to foster good judgment of height and movement, your head should assume a natural, straight-ahead position. Your visual focus should not be fixed on any one side or any one spot ahead of the powered parachute, but should be changing slowly from a point just over the powered parachute's nose-wheel to the desired touchdown zone and back again, while maintaining a deliberate awareness of distance from either side of the runway within your peripheral field of vision. Accurate estimation of distance is, besides being a matter of practice, dependent upon how clearly objects are seen; it requires that vision be focused properly for the important objects to stand out as clearly as possible.

Speed blurs objects at close range. For example, consider the view from an automobile moving at high speed. Nearby objects seem to merge together in a blur, while objects farther away stand out clearly. The driver subconsciously focuses the eyes sufficiently far ahead of the automobile to see objects distinctly. In the same way, the distance at which the powered parachute pilot's vision is focused is normally adjusted automatically.

If you attempt to focus on a reference that is too close or look directly down, the reference will become blurred, and the reaction will be either too abrupt or too late. In this case, your tendency will be to over-

control, round out high, and make drop-in landings. When you focus too far ahead, accuracy in judging the closeness of the ground is lost and the consequent reaction will be too slow since there will not appear to be a necessity for action. This will result in flying into the ground without flaring.

## Roundout

The powered roundout is a slow, smooth transition from a normal approach descent rate to a landing descent rate, gradually rounding out the flightpath to one that is parallel with, and within a very few inches above the runway. When the powered parachute is in a normal descent, within what appears to be 10 to 20 feet above the ground, the powered roundout should be started. Once started, it should be a continuous process until the powered parachute touches down on the ground.

As the powered parachute reaches a height above the ground where a timely change can be made into the proper landing descent, power should be gradually applied to slowly decrease the rate of descent. [Figure 11-3]

The rate at which the roundout is executed depends on the powered parachute's height above the ground and the rate of descent. A roundout started excessively high must be executed more slowly than one from a lower height to allow the powered parachute to descend to the ground. The rate of rounding out must also be proportionate to the rate of closure with the

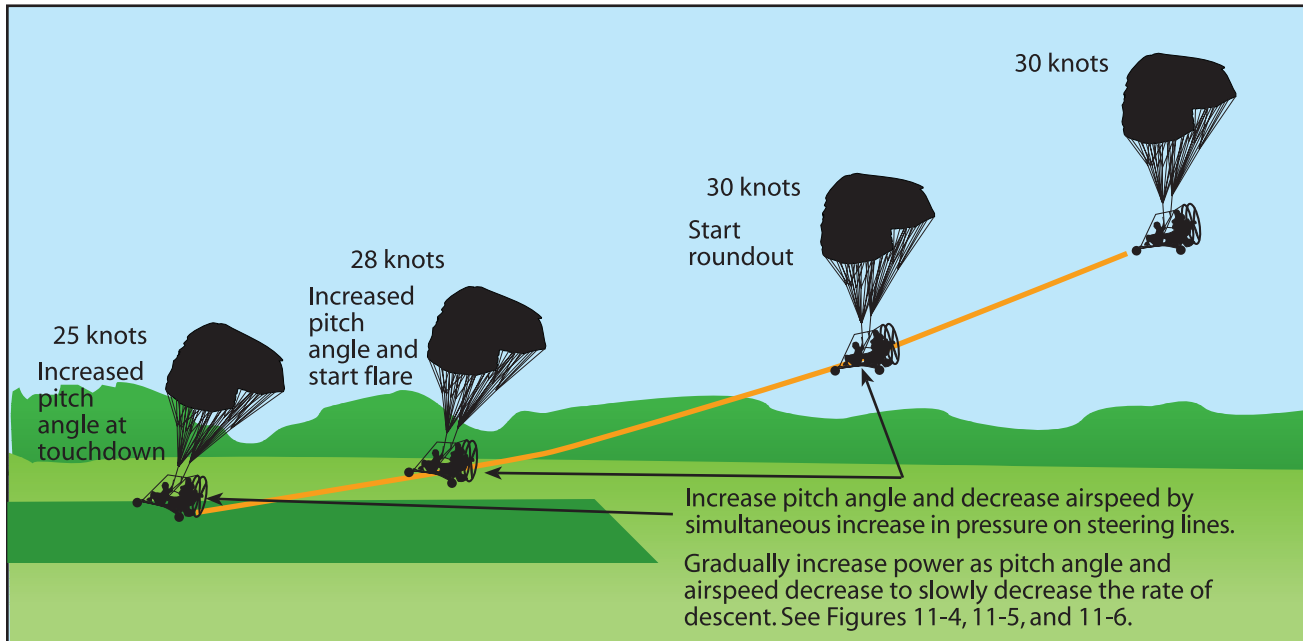

**Figure 11-3. Changing pitch angle and decreasing airspeed during roundout.**

ground. When the powered parachute appears to be descending very slowly, no increase in power settings is called for.

Visual cues are important in rounding out at the proper altitude and maintaining the wheels a few inches above the surface until eventual touchdown. Visual cues are primarily dependent on the angle at which your central vision intersects the ground (or runway) ahead and slightly to the side. Proper depth perception is a factor in a successful flare, but the visual cues used most are those related to changes in runway or terrain perspective and to changes in the size of familiar objects near the landing area such as fences, bushes, trees, hangars, and even sod or runway texture. You should direct central vision at a shallow downward angle of from  $10^{\circ}$  to  $15^{\circ}$  toward the runway as the roundout is initiated.

Maintaining the same viewing angle causes the point of visual interception with the runway to move progressively rearward toward you as the powered parachute loses altitude. This is an important visual cue in assessing the rate of altitude loss. Conversely, forward movement of the visual interception point will indicate an increase in altitude, and would mean that power was increased too rapidly, resulting in floating. In most powered parachutes, the front wheel can easily be seen and can be used as an indicator of how far the main wheels are above the runway.

In some cases, it may be necessary to advance the throttle slightly to prevent an excessive rate of sink

which would result in a hard, drop-in type landing. You should keep one hand on the throttle throughout the approach and landing, in case a sudden and unexpected hazardous situation requires an immediate application of power.

## Wing Control

The measured input of the flare is directly related to the leg extension of the pilot. For one-third flare, simultaneously push the steering controls out approximately one-third of your leg length. During a full-flare, you would be fully extending your legs to apply input to the steering controls; one-half flare, you would be pushing the controls out half of your full leg extension, and so on. [Figure 11-4]

For landings, the amount of flare needed is directly related to the descent rate. The steeper and faster the descent, the more flare input is required for a smooth landing. [Figure 11-5] Keep in mind the flare is converting forward momentum into lift. So, if the pilot is landing with a very slow descent rate, then the pilot would only need to apply one-third flare during the landing. Use full-flare during an engine-out descent, which is the steepest descent of a PPC, for landing.

A flare should be applied in a single 1-2-3 motion. Apply the flare smoothly, in a rhythmic, even, "1-2-3" motion.

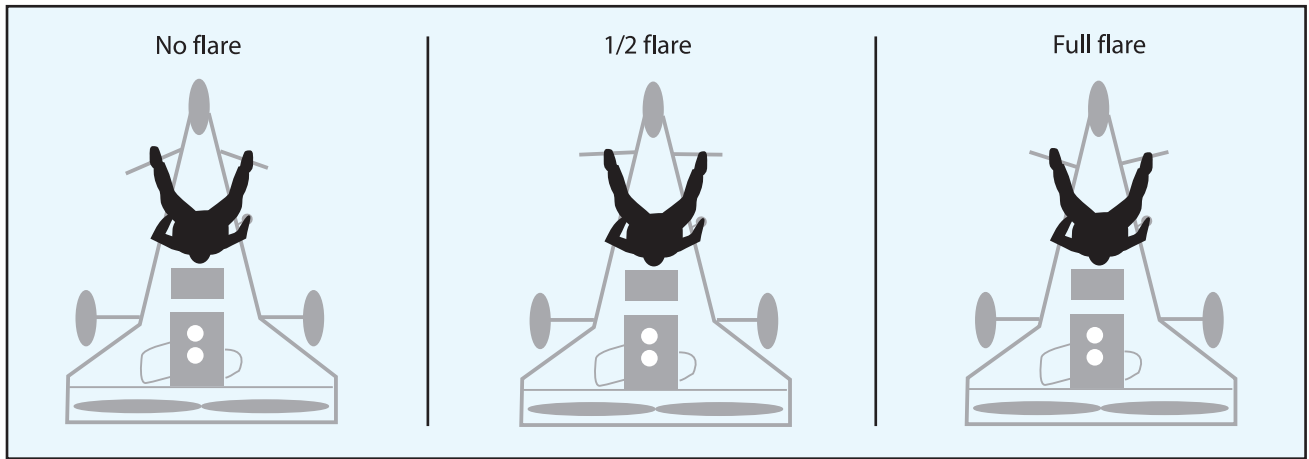

Figure 11-4. Flare is measured relative to the pilot's leg length.

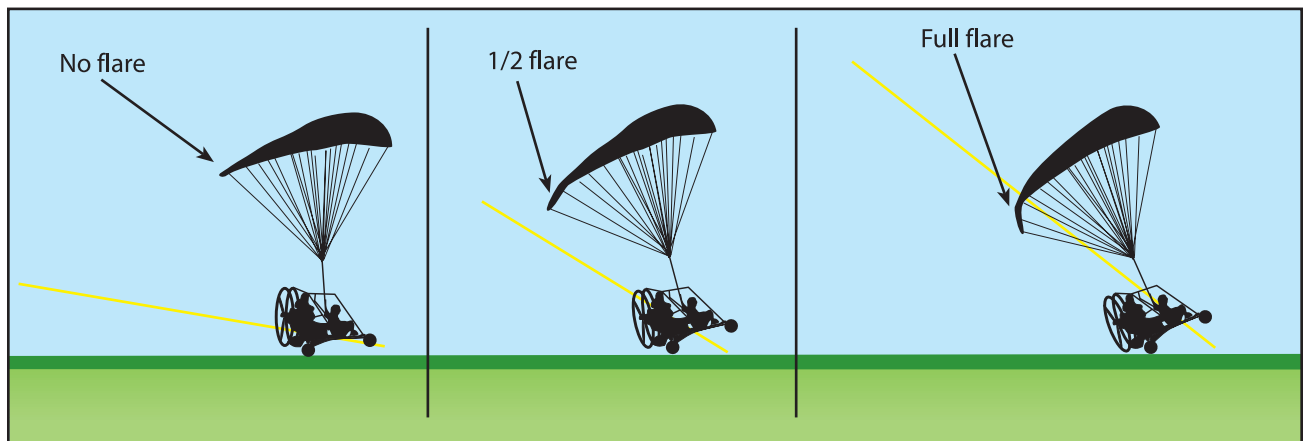

Figure 11-5. The steeper the descent rate, the greater the need for flare.

## Touchdown

The touchdown is the gentle settling of the powered parachute onto the landing surface. The roundout and touchdown should be made with the engine slightly below level flight power levels. As the powered parachute settles, the parachute is flared to smooth out the landing.

Some pilots may try to force or fly the powered parachute onto the ground without flaring. It is paradoxical that the way to make an ideal landing is to try to hold the powered parachute's wheels a few inches off the ground as long as possible. In most cases, when the wheels are within a foot or less off the ground, the powered parachute will still be settling too fast for a gentle touchdown; therefore, this rate of descent must be retarded by the use of flare. [Figure 11-6]

Flare is accomplished by pushing both steering bar tubes simultaneously. That pulls the entire trailing edge of the parachute down. That increases drag, lowers the forward speed, and most importantly (for land-

ing) increases the lift of the parachute. The amount of flare needed depends on the rate of descent right before landing. If the rate of descent is very gradual, very little flare is needed. Conversely, in an engine-out situation a lot of flare is required. Accurately determining how much flare is needed for a given situation is developed with practice. A general rule is to begin the flare one second before you would otherwise touch the ground.

Flare is used rather than engine power because the wing is much more responsive in controlling descent and pitch than engine power. When you add flare, the drag on the wing increases and the wing quickly responds by rotating backwards and increasing its pitch angle. In order to achieve the same effect with engine power, you add throttle, the propeller speeds up, and the thrust pushes the cart (which is much heavier than a parachute) forward of the wing. It is easier to change the inertia and positioning of a 25-pound wing than a 500+ pound cart-engine-pilot-fuel assembly.

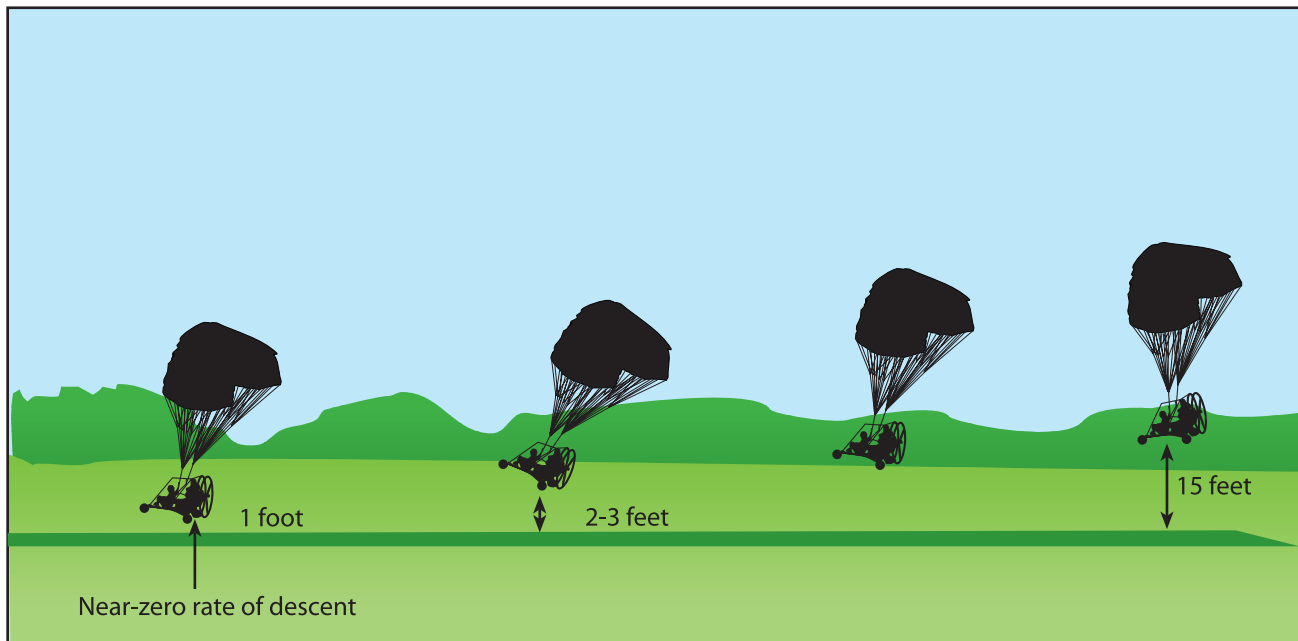

**Figure 11-6. A well executed roundout results in attaining the proper landing attitude.**

It is extremely important the touchdown occur with the powered parachute's longitudinal axis exactly parallel to the direction in which the PPC is moving along the surface. Failure to accomplish this imposes side loads on the landing gear. To avoid these side stresses, you should try to not allow the PPC to touch down while drifting.

## After-Landing Roll

The landing process must never be considered complete until the powered parachute has been brought to a complete stop, the engine shut down, and the wing collapsed and on the ground. Many accidents have occurred as a result of pilots abandoning their vigilance and positive control after getting the powered parachute on the ground. Some have damaged their parachute by failing to stop the engine before the wing falls into the moving propeller. Other incidents have occurred where the wind has caught a still-inflated wing and rolled the powered parachute over.

Normally as soon as you have landed, you should do four things in this order:

1. Release any flare that was used during landing. Once the flare is released, the wing will rotate forward relative to the cart. That decreases both the angle of attack and lift that the landing flare generated. With the flare released, there will be more load put on the front landing gear, which in turn makes the powered parachute easier to ground handle.

2. Unless you have the intention to taxi the powered parachute with the parachute inflated, close the throttle.
3. Shut down the ignition system. Normally, powered parachutes have two toggle ignition switches. Both toggle switches must be turned off to shut down the engine.
4. The parachute needs to be collapsed and grounded. This is done by tugging on the parachute steering lines. One long pull will generally not be adequate. Three or four quick tugs will normally be enough. The wing rotating and collapsing behind the cart will also act as a brake for the powered parachute, much like a drogue chute. [Figure 11-7]

Landings should always be planned to be done directly into the wind. However, if you must land in a crosswind, you may be able to land but you will not be able to takeoff. You can land on higher crosswinds than you can take off.

A wide runway may allow you the capability to land across the runway. However, a narrow runway would not allow this. Therefore, if you must land in a crosswind, during final approach, crab into the wind and line up on the runway centerline. Approach with this crab and flare as you normally would. Reduce power as your back wheels touch. When your back wheels touch, your front wheel will swing around, straight down the runway. However your wing will still be headed into the wind. Shut the engine down and continue pulling the steering lines to get the canopy down on the ground immediately since you can not taxi in a crosswind.



Figure 11-7. Collapsing the parachute.

## Stabilized Approach Concept

A stabilized approach is one in which the pilot establishes and maintains a constant angle glidepath towards a predetermined point on the landing runway. It is based on the pilot's judgment of certain visual clues, and depends on the maintenance of a constant final approach.

A powered parachute descending on final approach at a constant rate will be traveling in a straight line toward a spot on the ground ahead. This spot will not be the spot on which the powered parachute will touch down, because some float will inevitably occur during the powered roundout and flare.

The point toward which the powered parachute is progressing is termed the "aiming point." [Figure 11-8] It is the point on the ground at which, if the powered parachute maintains a constant glidepath, and was not rounded out or flared for landing, it would strike the ground. To a pilot moving straight ahead toward an object, it appears to be stationary. It does not "move." This is how the aiming point can be distinguished—it *does not move*. However, objects in front of and beyond the aiming point do appear to move as the distance is closed, and they appear to move in opposite

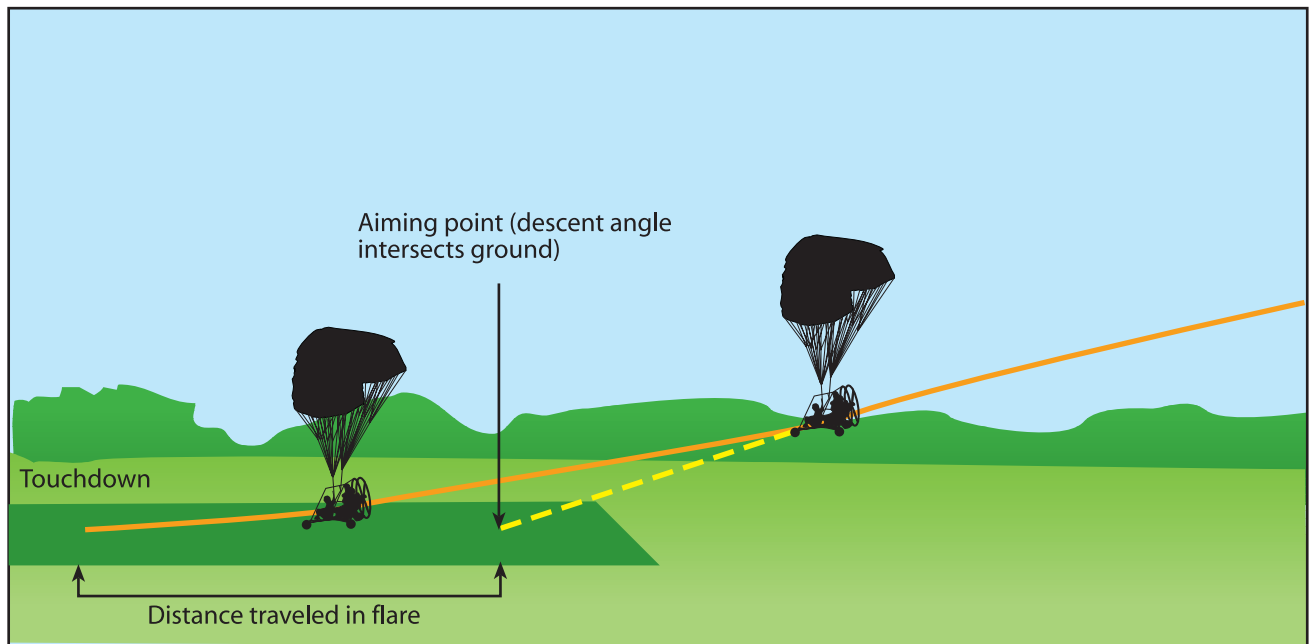

Figure 11-8. Stabilized approach.

directions. During instruction in landings, one of the most important skills a student pilot must acquire is how to use visual cues to accurately determine the true aiming point from any distance out on final approach. From this, the pilot will not only be able to determine if the glidepath will result in an undershoot or overshoot, but, taking into account float during roundout, the pilot will be able to predict the touchdown point to within a very few feet.

For a constant angle glidepath, the distance between the horizon and the aiming point will remain constant. If a final approach descent has been established but the distance between the perceived aiming point and the horizon appears to increase (aiming point moving down away from the horizon), then the true aiming point, and subsequent touchdown point, is farther down the runway. If the distance between the perceived aiming point and the horizon decreases (aiming point moving up toward the horizon), the true aiming point is closer than perceived.

When the powered parachute is established on final approach, the shape of the runway image also presents clues as to what must be done to maintain a stabilized approach to a safe landing.

The objective of a stabilized approach is to select an appropriate touchdown point on the runway, and adjust the glidepath so the true aiming point and the desired touchdown point basically coincide. Immediately after rolling out on final approach, you should adjust the power so the powered parachute is descending directly toward the aiming point. With the approach set up in this manner, you will be free to devote full attention toward outside references. You should not stare at any one place, but rather scan from one point to another, such as from the aiming point to the horizon, to the trees and bushes along the runway, to an area well short of the runway, and back to the aiming point. In this way, you will be more apt to perceive a deviation from the desired glidepath, and whether or not the powered parachute is proceeding directly toward the aiming point.

If the aiming point on the runway is not where you want it, adjust the glidepath. This in turn will move the aiming point. For instance, if you perceive the aiming point is short of the desired touchdown point and will result in an undershoot, increase the engine power. The power change must be made smoothly. This will result in a shallower glidepath with the resultant aiming point moving towards the desired touchdown point. Conversely, if the aiming point is

farther down the runway than the desired touchdown point and you suspect it will result in an overshoot, steepen the glidepath by decreasing power.

The closer the powered parachute gets to the runway, the larger (and possibly more frequent) the required corrections may become, resulting in an unstabilized approach.

Common errors in the performance of normal approaches and landings are:

- Inadequate wind drift correction on the base leg.
- Overshooting or undershooting the turn onto final approach resulting in too steep or too shallow a turn onto final approach.
- Unstabilized approach.
- Focusing too close to the powered parachute resulting in a too high roundout.
- Focusing too far from the powered parachute resulting in a too low roundout.
- Flaring the parachute too early before touchdown.
- Touching down prior to attaining proper landing attitude.
- Failure to release the flare after touchdown.

## **Go-Arounds (Rejected Landings)**

Whenever landing conditions are not satisfactory, a go-around is warranted. There are many factors that can contribute to unsatisfactory landing conditions. Situations such as air traffic control requirements, unexpected appearance of hazards on the runway, overtaking another powered parachute, wind shear, wake turbulence, mechanical failure and/or an unstabilized approach are all examples of reasons to discontinue a landing approach and make another approach under more favorable conditions. The assumption that an aborted landing is invariably the consequence of a poor approach, which in turn is due to insufficient experience or skill, is a fallacy. The go-around is not strictly an emergency procedure. It is a normal maneuver that may at times be used for normal situations. It does not need to be an emergency to do a go-around. Like any other normal maneuver, the go-around must be practiced and perfected. The flight instructor should emphasize early on, and the student pilot should understand, that the go-around maneuver is an alternative to any approach and/or landing.

Although the need to discontinue a landing may arise at any point in the landing process, the most critical go-around will be one started when very close to the ground. Therefore, the earlier a condition that warrants

a go-around is recognized, the safer the go-around/rejected landing will be. The go-around maneuver is not inherently dangerous in itself. It becomes dangerous only when delayed unduly or executed improperly.

Delay in initiating the go-around normally stems from two sources: (1) landing expectancy, or set—the anticipatory belief that conditions are not as threatening as they are and that the approach will surely be terminated with a safe landing, and (2) pride—the mistaken belief that the act of going around is an admission of failure—failure to execute the approach properly. The improper execution of the go-around maneuver stems from a lack of familiarity with the three cardinal principles of the procedure: **power, power, and power.**

Power is your first concern. The instant you decide to go around, *full* power must be applied smoothly and without hesitation, and held until the powered parachute climbs back to pattern altitude. Applying only partial power in a go-around is never appropriate. You must be aware of the degree of inertia that must be overcome, before a powered parachute that is settling towards the ground can become capable of turning safely or climbing. The application of power should be smooth as well as positive. Abrupt movements of the throttle in some powered parachutes will cause the engine to falter.

Common errors in the performance of go-arounds (rejected landings) are:

- Failure to recognize a condition that warrants a rejected landing.
- Indecision.
- Delay in initiating a go-around.
- Failure to apply maximum allowable power in a timely manner.
- Abrupt power application.
- Failure to adequately compensate for torque/P-factor.

## Turbulent Air Approach and Landing

Powered parachute flying is a low-wind sport. It is important PPC pilots evaluate the upper-air winds to ensure the wind is within the limitations for that aircraft, accounting for wind shear and wind gust possibilities at pattern altitude.

For flying in more turbulent air on final approach, maintain power throughout the approach to reduce your descent rate in case you do experience a down gust. This will alleviate the possibility of an excessive descent rate.

## Emergency Approaches and Landings (Simulated)

From time to time on dual flights, the instructor should give simulated emergency landings by retarding the throttle and calling “simulated emergency landing.”

The objective of these simulated emergency landings is to develop the pilot’s accuracy, judgment, planning, procedures, and confidence when little or no power is available.

A simulated emergency landing may be given at any time. When the instructor calls “simulated emergency landing,” the pilot should consider the many variables, such as altitude, obstruction, wind direction, landing direction, landing surface and gradient, and landing distance requirements. Risk management must be exercised to determine the best outcome for the given set of circumstances. The higher the altitude, the more time the pilot has to make the decision of where to land.

Using any combination of normal gliding maneuvers, from wing level to turns, the pilot should eventually arrive at the normal key position at a normal traffic pattern altitude for the selected landing area. From this point on, the approach will be as nearly as possible a normal power-off approach. [Figure 11-9]

All pilots should learn to determine the wind direction and estimate its speed. This can be done by observing the windsock at the airport, smoke from factories or houses, dust, brush fires, and windmills.

Once a field has been selected, the student pilot should always be required to indicate it to the instructor. Normally, the student should be required to plan and fly a pattern for landing on the field elected until the instructor terminates the simulated emergency landing. This will give the instructor an opportunity to explain and correct any errors; it will also give the student an opportunity to see the results of the errors.

However, if the student realizes during the approach that a poor field has been selected—one that would obviously result in disaster if a landing were to be made—and there is a more advantageous field within gliding distance, a change to the better field should be permitted. The hazards involved in these last-minute decisions, such as excessive maneuvering at very low altitudes, should be thoroughly explained by the instructor.



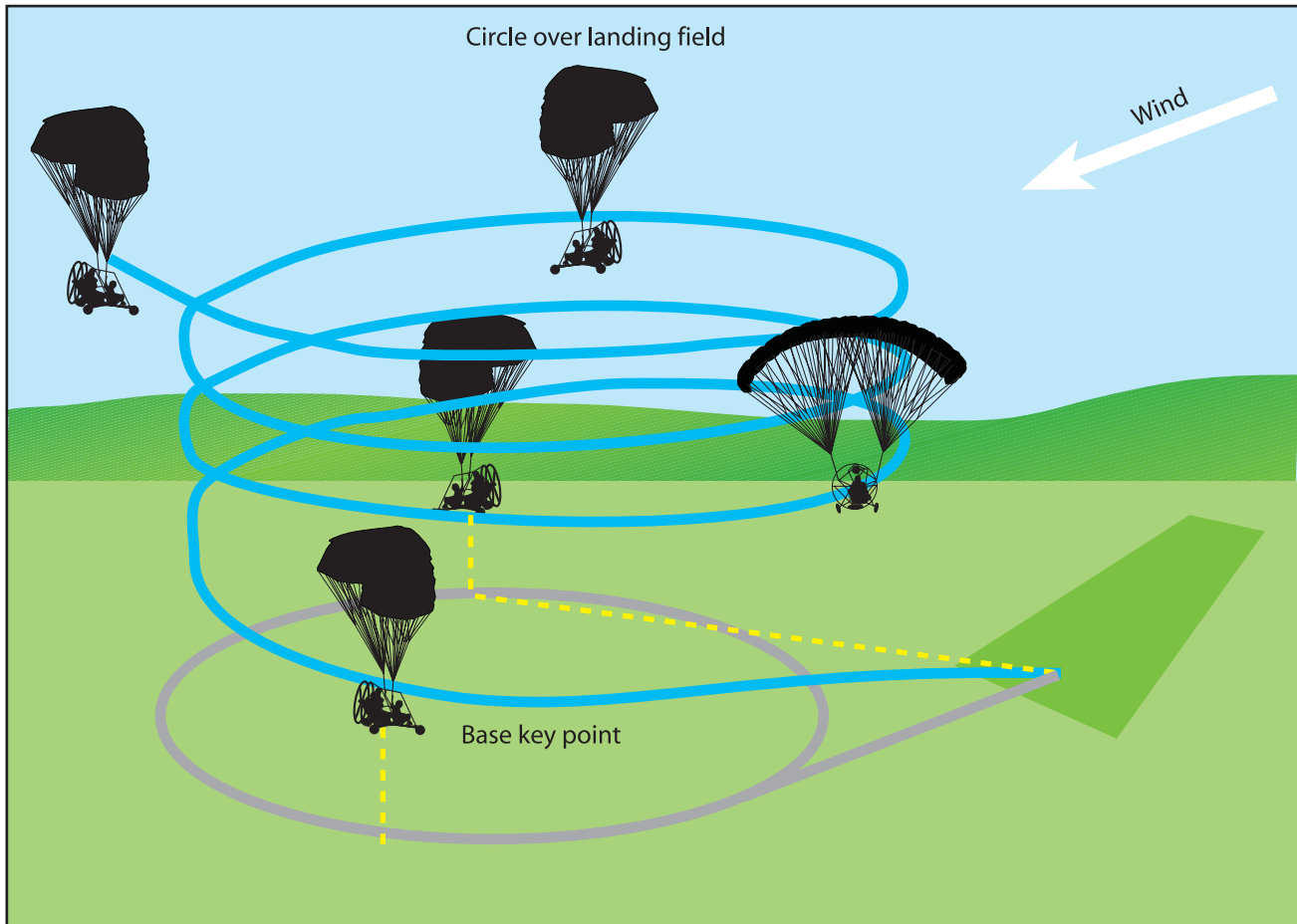

**Figure 11-9. Remain over intended landing area; once selected, never have the landing zone behind the pilot/aircraft.**

During all simulated emergency landings, the engine should be kept warm and cleared. During a simulated emergency landing, either the instructor or the student should have complete control of the throttle. There should be no doubt as to who has control since many near accidents have occurred from such misunderstandings.

Every simulated emergency landing approach should be terminated as soon as it can be determined whether a safe landing could have been made. In no circumstances should you violate the altitude restrictions detailed in 14 CFR part 91 or any local nonaviation regulations in force. It is also important to be courteous to anyone on the ground. In no case should it be continued to a point where it creates a hazard or an annoyance to persons or property on the ground.

In addition to flying the powered parachute from the point of simulated engine failure to where a reasonable safe landing could be made, the pilot should also learn certain emergency cockpit procedures. The habit of performing these cockpit procedures should be developed to such an extent that, when an engine failure actually occurs, the pilot will check the critical items

that would be necessary to get the engine operating again after selecting a field and planning an approach. Accomplishing emergency procedures and executing the approach may be difficult for the pilot during the early training in emergency landings.

There are definite steps and procedures to follow in a simulated emergency landing. They should be learned thoroughly by the student, and each step called out to the instructor. The use of a checklist is strongly recommended. Most powered parachute manufacturers provide a checklist of the appropriate items. [Figure 11-10]

Critical items to be checked should include the quantity of fuel in the tank and the position of the ignition switches. Many actual emergency landings could have been prevented if the pilots had developed the habit of checking these critical items during flight training to the extent that it carried over into later flying.

Instruction in emergency procedures should not be limited to simulated emergency landings caused by power failures. Other emergencies associated with the operation of the powered parachute should be ex-

Partial or complete power loss during flight enroute—determination of best suitable landing area:

- Look for a suitable landing area considering terrain/obstacles/wind.
- Maintain control of the aircraft.
- Only after the aircraft is under control and a suitable landing area is established should you try to restart the engine if you have enough altitude and time. Again, always maintain control of the aircraft.
- Check fuel and position of ignition switches.
- Determine best approach considering wind/obstacles/terrain.

**Figure 11-10. Sample emergency checklist.**

plained, demonstrated, and practiced if practicable. Among these emergencies are such occurrences as fire in flight, electrical system malfunctions, unexpected severe weather conditions, engine overheating, imminent fuel exhaustion, and the emergency operation of powered parachute systems and equipment.

## Faulty Approaches and Landings

### Low Final Approach

When the base leg is too low, insufficient power is used or the velocity of the wind is misjudged, sufficient altitude may be lost, which will cause the powered parachute to be well below the proper final approach path. In such a situation, you would have to apply considerable power to fly the powered parachute (at an excessively low altitude) up to the runway threshold.

When it is realized the runway will not be reached unless appropriate action is taken, power must be applied immediately to stop the descent. When the proper approach path has been intercepted, the correct approach attitude should be re-established and the power reduced and a stabilized approach maintained. [Figure 11-11] If there is any doubt about the approach being safely completed, it is advisable to EXECUTE AN IMMEDIATE GO-AROUND.

### High Final Approach

When the final approach is too high, reduce power as required. [Figure 11-12] When the proper approach path has been intercepted, adjust the power as required to maintain a stabilized approach. When steepening the approach path, however, care must be taken

that the descent does not result in an excessively high sink rate. If a high sink rate is continued close to the surface, it may be difficult to slow to a proper rate prior to ground contact. Any sink rate in excess of 800–1,000 feet per minute is considered excessive. A go-around should be initiated if the sink rate becomes excessive.

### Use of Power

Power can be used effectively during the approach and roundout to compensate for errors in judgment. Power can be added to slow the descent rate to an acceptable rate. Some pilots use power rather than wing flare to land smoothly. After the powered parachute has touched down, it will be necessary to close the throttle so the additional thrust and lift will be removed and the powered parachute will stay on the ground.

### High Roundout

It is possible to flare for landing too high above the ground. [Figure 11-13] If this happens, efforts need to be made to prevent the wing from surging forward. The power should not be reduced and the flare should only be reduced slightly or the wing could surge forward as the pendulum starts swinging back. Some pilots try to correct this situation by reducing the throttle too much and letting off the flare completely in order to land closer to their chosen landing point. This invariably results in the cart rotating back under the forward surging wing and diving towards the ground because lift has been dramatically reduced. Any surging forward of the wing above the cart should be slowed by increased flare. If the flare is performed too high off the ground, a go-around can be accomplished.

It is recommended that a go-around be executed any time it appears that there may not be enough runway to safely land the powered parachute or if the landing is in any other way uncertain.

### Bouncing During Touchdown

When the powered parachute contacts the ground with a sharp impact as the result of an excessive sink rate, the cart tends to bounce back into the air.

The corrective action for a bounce when it is very slight is to make a follow-up landing by applying sufficient power to cushion the subsequent touchdown and by adding flare as needed.

When a bounce is severe, the safest procedure is to EXECUTE A GO-AROUND IMMEDIATELY. No attempt to salvage the landing should be made. Ap-

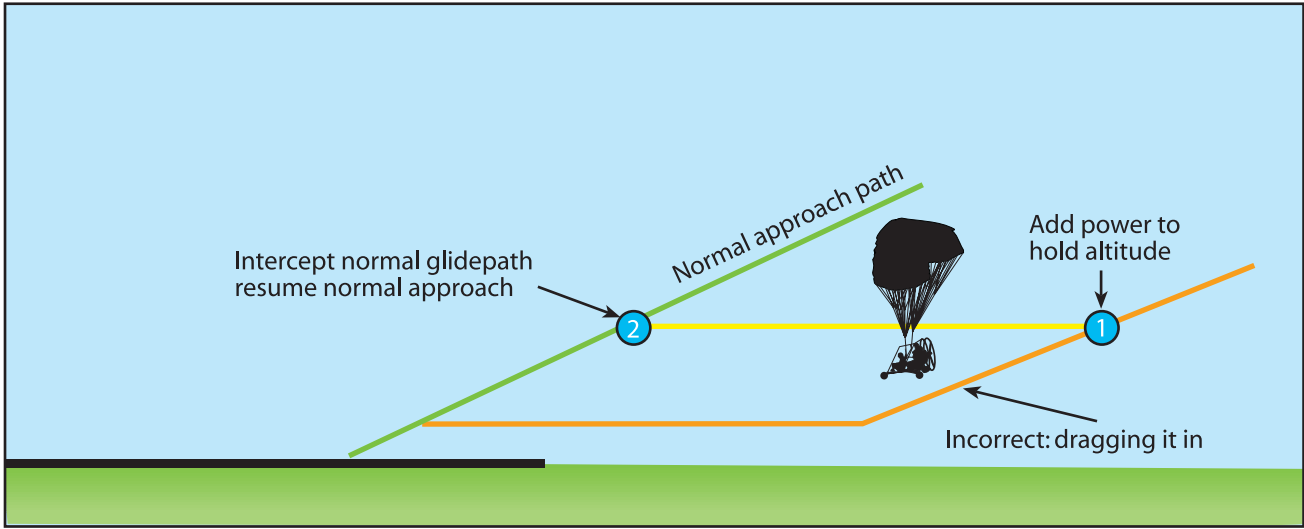

Figure 11-11. Right and wrong methods to correct a low final approach.

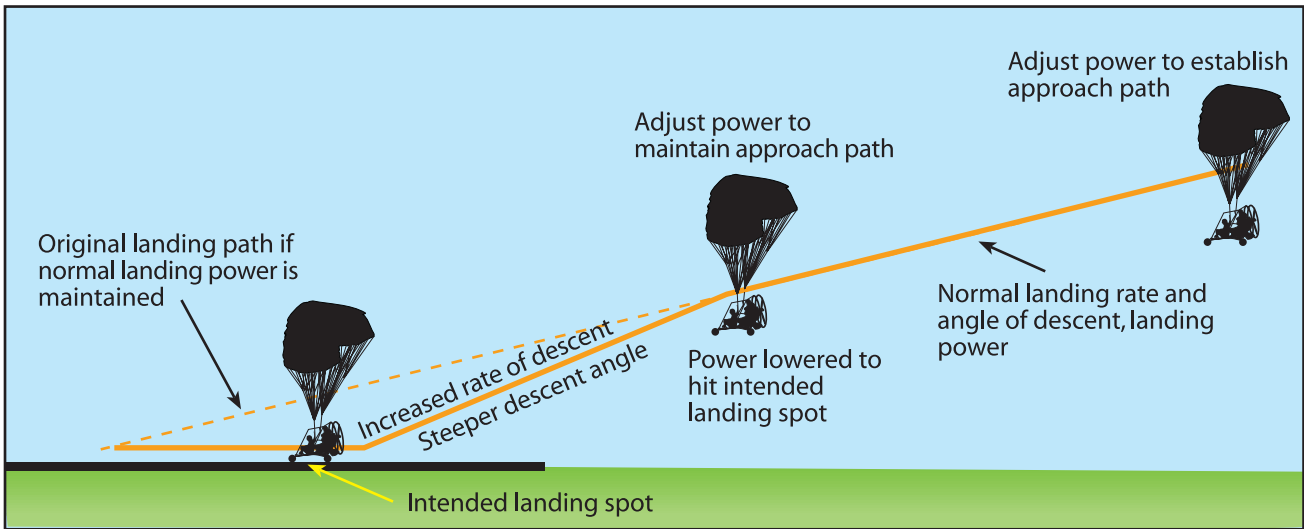

Figure 11-12. Change in glidepath and increase in descent for high final approach.

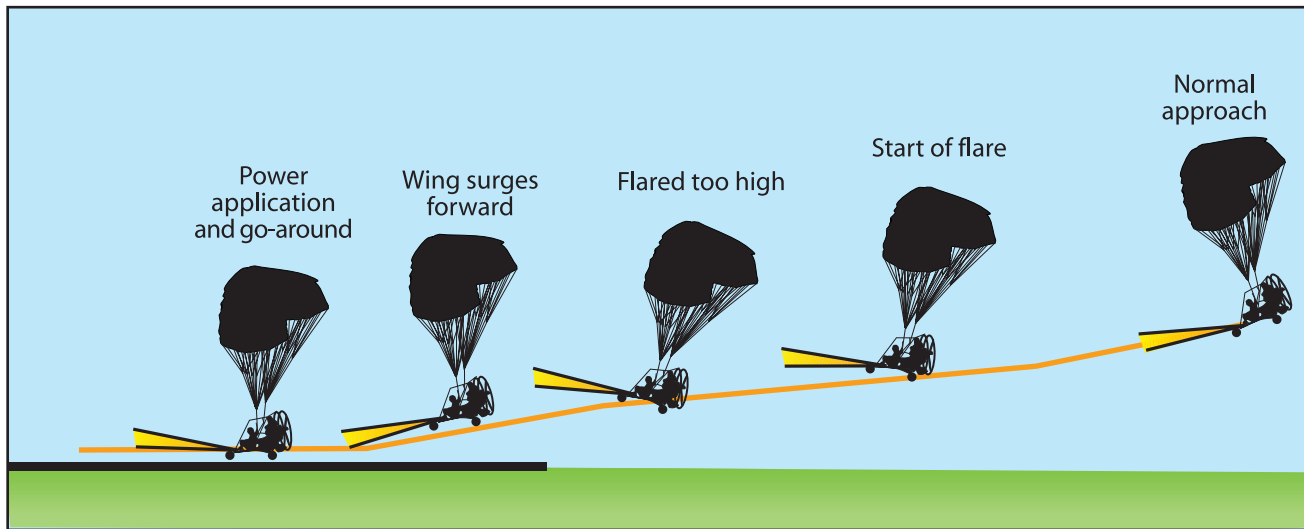

Figure 11-13. Rounding out too high.

ply full power and check the wing is LOC (lines free, cells open, wing centered) since a hard landing can collapse a ram-air wing. It would be extremely foolish to attempt a landing from a bad bounce since the skill set that would allow a student to make a severe bounce would not be up to the task of salvaging a bad landing.

### **Hard Landing**

When the powered parachute contacts the ground during landings, its vertical speed is instantly reduced to zero. Unless provisions are made to slow this vertical speed and cushion the impact of touchdown, the force of contact with the ground may be so great it could cause structural damage to the powered parachute. Reductions in rapid descent rates are made through throttle increases. Closer to the ground, additional flare is applied before touchdown.

The purpose of pneumatic tires, shock absorbing landing gears, and other devices is to cushion the impact and to increase the time in which the powered parachute's vertical descent is stopped. Within a fraction of a second, the powered parachute must be slowed from a high rate of vertical descent to zero, without damage.

During this time, the landing gear together with some aid from the lift of the ram-air wing must supply whatever force is needed to counteract the force

of the powered parachute's inertia and weight. The lift decreases rapidly as the powered parachute's forward speed is decreased, and the force on the landing gear increases by the impact of touchdown. When the descent stops, the lift will be zero, leaving the landing gear alone to carry both the powered parachute's weight and inertia force. Any time you have a hard landing, inspect your landing gear, tires, and structure to make sure there is no structural damage.

### **Wing Blowing Over After Touchdown**

When landing in a crosswind, there is a concern that the wing will blow downwind during the after-landing roll. This is due to the fact that the wing is flexibly attached to the cart.

Anytime a powered parachute is rolling on the ground in a crosswind condition, the upwind side of the parachute is receiving a force that wants to push it downwind.

If no correction is applied, it is possible that the upwind side of the parachute will rise sufficiently to cause the downwind side of the parachute to strike the ground. If the wind and/or the forward motion of the powered parachute is great enough, a rollover may result. It is important for a pilot to remember that the parachute should be flown or pulled to the ground right after landing the cart. The cart and the parachute's movements should be controlled together on the ground.



# CHAPTER 12

## NIGHT, ABNORMAL & EMERGENCY PROCEDURES

### Night Operations and the Powered Parachute

Flying a powered parachute after sunset requires a private pilot powered parachute certificate. In addition, the powered parachute needs to be equipped for night operations by adding position lights for taxi and flight. Position lights are green on the right, red on the left, and white in the back. Anti-collision strobe lights can also be used in addition to position lights. [Figure 12-1]

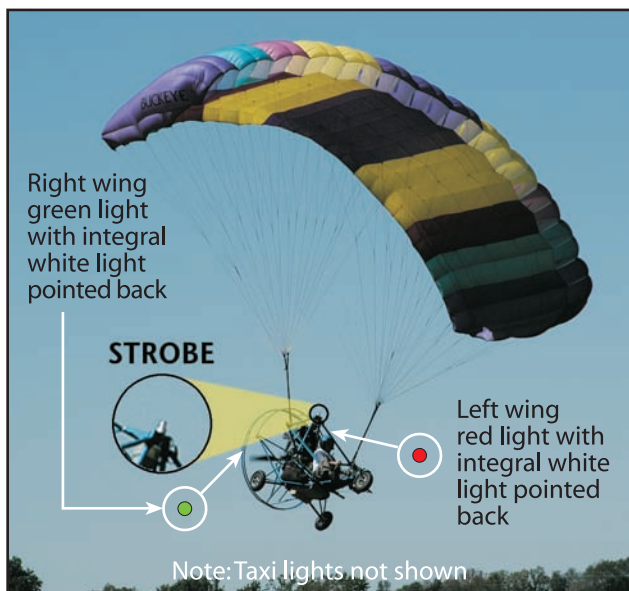

**Figure 12-1. Powered parachutes must be specifically equipped for night flight.**

The use of lighted runways for night flight imposes several problems for the powered parachute pilot. Setting up on a runway and conducting a preflight on a powered parachute cart and wing in the dark could tie up a designated runway area for a considerable amount of time, not to mention raise issues about being able to see the aircraft and wing components for proper preflight inspection.

A pilot planning to fly a powered parachute at night should ensure adequate illumination is provided for takeoff. The wing needs to be illuminated to ensure the wing cells are all open, the wing is centered, and

the lines are not tangled (LOC). The takeoff area needs adequate illumination to ensure hazards are avoided. Typically, lights on poles can present a hazard at an airfield.

A powered parachute flight where the preflight inspection was completed during daylight, just prior to sunset, and then the final landing made after sunset may be a more feasible endeavor. If a powered parachute pilot holding a private pilot certificate or higher were to venture into night flight, Chapter 15 of the *Pilot's Handbook of Aeronautical Knowledge* should be carefully reviewed to understand the parameters that need to be considered prior to conducting a flight in the dark.

### Emergency Situations

This section contains information on dealing with unexpected situations that may occur in flight. The key to successful management of an emergency situation, and/or preventing a problem from progressing into a true emergency, is a thorough familiarity with, and adherence to, the procedures developed by the powered parachute (PPC) manufacturer. Hence, the following guidelines are generic and are not meant to replace the manufacturer's recommended procedures. Rather, they are meant to enhance your general knowledge in the area of emergency operations. If any of the guidance in this chapter conflicts in any way with the manufacturer's recommended procedures, the manufacturer's recommended procedures take precedence.

Review the lost procedures and flight diversion techniques in Chapter 14 of the *Pilot's Handbook of Aeronautical Knowledge*. You must be able to select an appropriate alternate airport or landing area and route, determine there is sufficient fuel to fly to the alternate airport or landing area, turn to and establish a course to the select alternate destination, and maintain the appropriate altitude and heading while doing so. As a PPC pilot you must be able to select an appropriate course of action if you become lost, including maintaining an appropriate heading and climb if necessary,

identify prominent landmarks, and use your navigation system (GPS) or contact an ATC facility for assistance, as appropriate.

Review the POH for the aircraft you fly to be familiar with the necessary pilot actions required for system and equipment malfunctions. You must be prepared to analyze the situation and take action if you experience any of the following system and equipment malfunctions: engine/oil and fuel, electrical, carburetor or induction icing, smoke and/or fire, flight control/trim, pitot static/vacuum and associated flight instruments, propeller, ballistic recovery system malfunction (if applicable), or any other emergency unique to the powered parachute you are flying.

### Accidents

It is estimated that 85 percent of accidents occur during the takeoff process, 10 percent transpire during landings, and 5 percent happen in flight. The vast majority of these accidents are the direct result of complacency. The cause of this complacency is that the PPC is relatively easy to fly. Hence, if you find complacency setting in, you need to turn from outside distractions, and direct your attention to the immediate situational awareness of the aircraft.

The following are some reasons for PPC complacency during flight:

- The PPC does not require quick reactions.
- When compared to other light-sport aircraft (LSA), the PPC flies very slowly.
- The PPC has only two axes around which you can directly control (lateral-pitch and vertical-yaw). Note: As there are no ailerons on a PPC, roll or movement around the longitudinal axis cannot be directly controlled. However, there is longitudinal roll invoked during a steep turn as the centrifugal force of the cart directs the cart to the outside of the suspension point of the wing.
- The controls are very intuitive (push right to go right, left to go left, more throttle to go up, and less to go down).

It is possible the outside environment can become a distraction to the necessary situational awareness of flying (i.e., situational complacency). Hence, in-flight accidents can be due to the pilot's failure to see obstructions (power lines and tower cables) and to anticipate weather-related turbulence and its resultant negative effects on a PPC's light wing (i.e., wind rotors or mechanical turbulence). Landing accidents are usually the result of porpoising (too rapid throttle movements), thermals, or unsafe field terrain. Takeoff problems can be caused by: (1) failure to get a wing

LOC before adding airborne power; and (2) failure to take off into the wind.

### Potential Hazards of the Standing PPC

Even while parked on the ground, high winds can pick up the wing of an unsecured powered parachute and begin carrying it away. To regain control of a free-standing PPC with a semi-inflated, dragging wing, rescuers need to grasp the steering lines—not the cart! Then with a steering line in hand, pull the line back toward the front of the cart (into the wind) and tie it off to any structured part of the PPC. This will keep the wing from gathering air and re-inflating. If you are by yourself, you do not have to do both lines simultaneously. It would be best to get both lines, but with a PPC that is dragging down the field, grab any steering line and get at least one line secured; then secure the second line. When you pull a steering line, the canopy will be pulled down on that side and the air in the wing will literally be pulled out, as the wing is hauled back and down.

The best safety procedure is prevention. To safeguard a PPC from high winds, immediately after landing, secure the wing. Even if you only intend to refuel, it is highly recommended to condense the exposure of the wing to the elements: the harmful ultraviolet rays of the sun and those unexpected wind gusts. As soon as possible after landing, condense the wing by folding it on top of itself and put something on top of it to secure it. It is best to pack the canopy to keep it out of the sun and make sure the wind cannot inflate the wing and if possible, lean the nose wheel up, then place the fan guard of the cart back and down on the folded wing. Securing it this way will usually be adequate for short breaks when the make and model allows for this static positioning. [Figure 12-2]



Figure 12-2. Secure the PPC wing when on the ground.

## Restricted Lines During the Takeoff Roll

If the lines (steering or suspension lines) become restricted, such as around part of an outrigger, a trim lock, or an accessory—then while safely maintaining your ground direction into the wind and holding your RPM down to kiting speed—reach out and push the line off of the restricting object. If this is not possible, then shut the PPC down and abort the takeoff.

To abort a takeoff (i.e., to shutdown) maintain your ground steering clear of obstacles as you: (1) power down the throttle, (2) push the magneto switches into the OFF position, and (3) pull the wing down.

### Entangled or Embedded Lines

If the lines become entangled or embedded with debris, then shut the PPC down and clean up the lines. If you don't, and you load the wing by beginning the lift-off, the stress on the lines as they pull through the debris (twigs, sticks, and so forth) can break the lines.

### Lines Caught Under a Wheel

If the lines go under a wheel, IMMEDIATELY abort the takeoff. Shut down: power, magnetos and wing down.

## A Wing Wall

The term “wall” is simply defined as the canopy literally forming a wall-like appearance behind the PPC. [Figure 12-3] The trailing edge of the canopy is still on the ground, while the leading edge of the canopy forms the top of the wall. The “wall” is the first canopy problem that might occur during the initial kiting of the wing.



Figure 12-3. A wing wall.

Even though some pilots will try to “pop” the canopy out of the “wall,” the only safe solution is to immediately abort the takeoff, and re-layout the canopy. By shutting down and restarting the takeoff preflight, pilots will save the expense of many line and propeller repairs. Lines will inevitably become damaged when a pilot tries to “pop” the canopy out of the wall via sharp throttle movements. When you fight the wall, you create an ideal situation for lines to get sucked into the propeller.

## A Wing Lock-Out

A wing “lock-out” occurs when the initial forward momentum is insufficient to move the canopy through the prop-wash and up and above the PPC cart. [Figure 12-4] During this phenomenon, the inflated canopy will hang at about a 45° angle behind the cart. This is a “parachutal-wing stall” while the pilot is still on the ground. Usually, regardless of how much ground-speed is increased, the wing will stay in a parachutal-wing stall behind the cart as long as the tension on the suspension lines remains the same; the wing will stay “locked-out” in that 45° position.

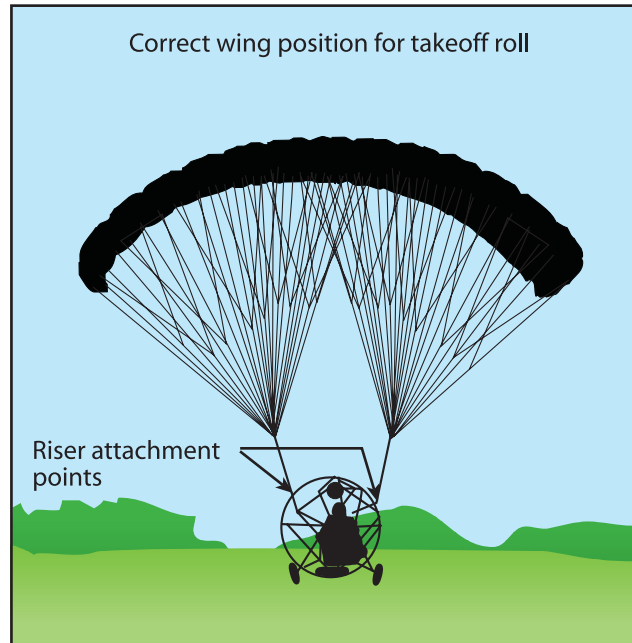
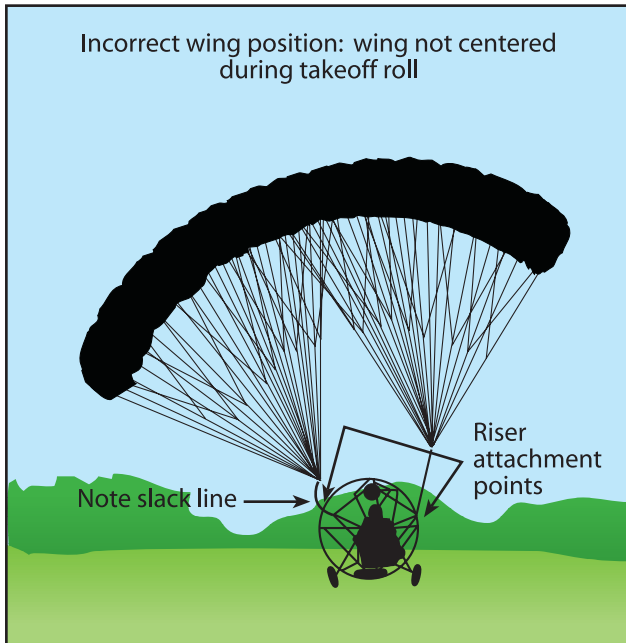

Figure 12-4. A wing lock-out.

There are two techniques that can be used to correct this “parachutal-wing stall” position of a rectangular wing:

1. Lower the groundspeed until the canopy begins to fall down and back behind the cart. Then before the wing touches the ground, smoothly and firmly increase the groundspeed to move (“sling-shot”) the canopy up and above the cart.
2. Maintain the groundspeed and pull the canopy back via a flare (i.e., pushing both foot steering bars). Hold the flare until the drag caused on the tail of the wing pulls the wing back down—about a 60° angle—and then smoothly release the flare. The release of the flare will again “sling-shot” the canopy up and above the cart.





**Figure 12-5. The wing should be centered and forward to the rise attachment points prior to takeoff.**

Note: Ask the advice of an instructor before using these techniques on an elliptical-shaped wing. The characteristics between the two types of PPC wings are significant in correcting the “Locked-Out” scenario.

## Wing Not Centered Overhead

No takeoff should ever be attempted until the wing is centered above the cart and forward to the riser attachment points. [Figure 12-5]

Hence, if the wing is not centered when it comes ahead to the riser attachment of the cart:

1. Keep steering into the wind, and
2. Keep your groundspeed below airborne (liftoff) speed.

The most noteworthy aspect of the takeoff preflight roll is to verify that the wing is positioned correctly. Due to the design, the wing will normally want to be up and centered above the cart. It also wants to weathervane into the wind. If you don’t rush the takeoff roll, and give the wing the time and speed it needs to adjust and settle overhead, the takeoff will be fine. The wing wants to be centered over the cart and pointing into the wind. You must steer into the wind during the entire takeoff roll.

You can adjust the wing’s position during your takeoff preflight roll once the wing is up and past the 45° position. When the wing is down on one side, apply steering input to the opposite side. Hence, if the wing is hanging down on the left side of the cart, push on

the right steering bar. The additional drag created on the right side will begin to pull the wing up to a more centered position (from being down on the left).

To compensate for the inertia of the wing’s movement as it is traveling upward, reduce the initial steering bar pressure, just before (not when) the wing is centered overhead. Then slowly add slight opposite steering bar pressure to compensate for possible over-correction (inertia) of the wing from center.

Remember: you do NOT need to manually move the wing center. The design of the wing and its attachment points create the tendency for the wing to be centered and overhead. You need only to steer the wing into the wind, allow the time needed to self correct, and provide the proper groundspeed to achieve proper wing position prior to takeoff.

## The Cart Turns Over (Roll-Over)

During a PPC taxi, you have two entities to steer: the wing and the cart. Until united in an airborne pendulum, the independent wing can follow one path, while the “grounded” cart may insist on another. This can result in a pull-over. [Figure 12-6] Normally this situation occurs when pilots are not headed into the wind during takeoff, or try a crosswind taxi beyond the PPC limitations or their current skill level.

The strongest inclination of a taxiing ram-air wing is to weathervane. The wing wants to point into the wind. However, if the pilot is steering the cart in a

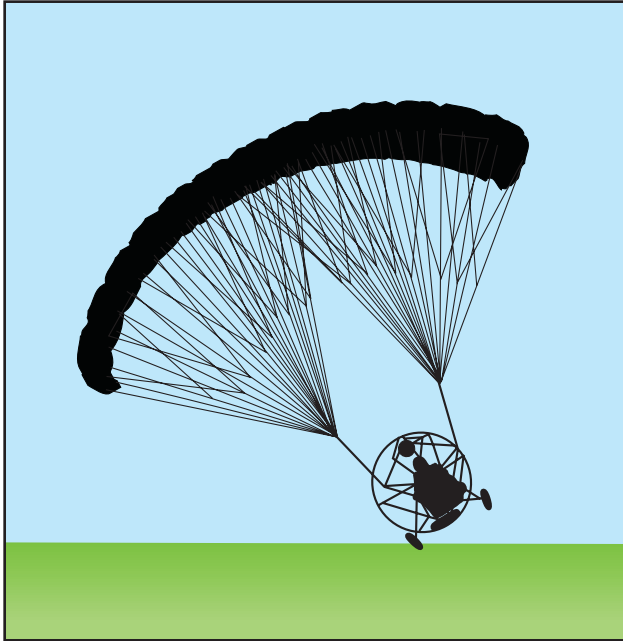

**Figure 12-6. A wing pull-over.**

different direction and has failed to notice the difference and has not corrected the wing over the center of the cart, then the wing can pull the cart over. The cart will be pulled over when the wing has been given the required airspeed to create the necessary lift to overcome the weight of the cart.

Since a taxiing cart has all its wheels on the ground, friction exists between the ground and the wheels. The friction causes the cart to travel in a particular direction. If the wing is in the air and pulling the cart in a different direction, opposing forces may be working against each other. You must prevent the wing from gaining enough force (horizontal lift) to pull the cart over on its side. Hence, caution must be used during taxi turns. Therefore, if the wing is not centered, and all the wing's cells are not open, or the suspension or steering lines are not clear of debris and free of frame obstructions, DO NOT increase the throttle to provide the wing enough airspeed to generate lift. Either shut down or slow down while pointing the cart into the wind and then correctly build the wing.

On a takeoff or landing, when you get hit with an unexpected side gust of wind, or try to take off before the wing is centered, the cart may be placed into a condition where it could be pulled over on its side by the horizontal lift of the wing. During a pull-over, you will react to one of two possible situations:

1. Your cart is lifting on one side, but you still have time to recover.
2. Your cart is up on one wheel; past the point of recovery and beginning to tip over.

In the first situation, to enhance the recovery, immediately remove the lifting force from the wing by reducing the groundspeed (i.e., reduce engine RPM via the throttle).

In the second and most uncomfortable situation of not being able to prevent the pull-over:

1. Immediately place the magneto switches OFF, to turn OFF the engine and stop the propeller.
2. Do not try to prevent the pull-over with your body (i.e., sticking out your arms and legs). Pull your arms and legs up into a tuck position to protect your limbs. When the aircraft comes to a stop, immediately unstrap and get out of the cart.
3. In the event the situation does not conflict with the provisions of Title 49, Code of Federal Regulations, Volume 5, Chapter VIII, Part 830 (49 CFR 830), move the unit back into an upright position (to prevent gas and oil from spilling out).

Keep in mind the above paragraph does NOT imply a wing pull-over should ever be a normal or periodic occurrence. These accidents can cause death or serious injuries and damage to your aircraft. With the proper training and understanding, a wing pull-over is easily prevented during the takeoff roll if you:

1. Keep the cart headed into the wind.
2. Stay calm, relaxed and don't rush your takeoff roll.
3. Realize it is the airspeed that is giving the wing lift, so slow down if you feel side lift and one rear wheel rising in a tipping fashion.
4. Let the cart settle back on all wheels as you maintain your heading into the wind.
5. Let the wing settle overhead, and allow all the cells to fully inflate.
6. Re-check the lines to make sure they are free and unrestricted.
7. Verify you do not have a "pig-tail" in the rear of the wing fabric or a friction knot in the lines.
8. Get your wing repositioned for takeoff, or abort the takeoff and get situated.

## **Engine Failure on Climbout**

Urgency characterizes all power loss or engine failure occurrences after lift-off. In most instances, the pilot has only a few seconds after an engine failure to decide the course of action and execute it. Unless prepared in advance to make the proper decision, there is a chance the pilot will make a poor decision, or make no decision at all and allow events to rule.

The altitude available is, in many ways, the controlling factor in the successful accomplishment of an

emergency landing. If an actual engine failure should occur immediately after takeoff and before a safe maneuvering altitude is attained, it is usually not advisable to attempt to turn back to the field from where the takeoff was made. Instead, it is safer to immediately establish the proper glide attitude, and select a landing area directly ahead or slightly to either side of the takeoff path. Complete the landing in accordance with the next section.

In the event of an engine failure on initial climb-out, the powered parachute is typically at a high pitch angle with the cart well in front of the wing. When the engine fails, the cart swings back under the wing and the wing can surge forward bringing the PPC into a temporary and potentially dangerous dive. If the engine-out occurs close to the ground, and the wing starts to surge out in front of the cart, it is necessary to immediately flare the wing to slow the surge. Gradually release the flare when the forward surge is controlled and the wing is back overhead in a normal flying position.

## Engine Failure In Flight

Never fly over something you cannot land on (considering your altitude and glide slope) and remain constantly aware of the surrounding terrain and hence potential landing zones. If you adhere to these rules, an in-flight engine failure will not directly correlate to an accident or incident. If this happens, continue to fly the aircraft. You simply glide it away from all obstacles and toward the safest landing area.

The safest landing zone may perhaps be in the middle of the flight park if you have a lot of altitude. Or, the best landing zone may be straight ahead if you are below 100 feet. If at all possible, set up your landing approach so you touch down into the wind—but the number one priority of an engine-out scenario is safe terrain (not ground wind direction). Wind direction is a secondary concern. Land into the wind if possible; otherwise land downwind. Crosswind is the least favorable wind direction to land into.

When you are about one second from touchdown, begin applying a full flare. [Figure 12-7] With a single 1-2-3 rhythmic timing motion, push both foot steering bars completely forward and hold that position as the rear wheels touch the ground. You can increase the amount of flare before landing, but you cannot release it when you are close to the ground and without power! Once on the ground smoothly release the flare and pull down the canopy (since the engine is already off).



**Figure 12-7. Engine-out, beginning full-flare about one second above the ground.**

## Engine Failure in a PPCL

When planning any over-water flight, wear a life vest. Maintain an altitude that will allow you to safely glide to land should the engine fail. [Figure 12-8] If you consistently fly over water, consider attaching an automatic, inflatable device or pontoons to the bottom of your PPC (i.e., so it becomes a PPCS with pontoons, as opposed to a PPCL in water). Carry a line-cutter that is easy to access, yet placed so as not to cause additional injury upon impact. Practice emergency procedures so you are prepared and brief your passengers on evacuation procedures prior to any over-water flight.



**Figure 12-8. You should not fly over water beyond your glide slope to the shore.**

If you find yourself over water with an engine failure, too far to glide to shore, remain strapped in so the cart can provide some impact protection. It is possible you will become disorientated, as the PPCL will likely flip over when you hit the water and settle upside-down in the water. You may become entangled in the wing and lines as it descends upon the craft and the occupants.

Although your PPCL may float for a few minutes, it will eventually sink. The time before sinking will depend on the amount of fuel left, the condition of the seals on the ends of your tubing, and the air left in your tires after impact.

As soon as you know a water landing is inevitable, your first step is to align your PPCL into the wind if possible, and move as close to shore as possible.

1. Don't panic. Use the ADM "DECIDE" method.
2. Stay seated.
3. Turn off all electronics.
4. Remove any objects that will delay your evacuation of the aircraft prior to impact (i.e., communication cords, camera straps, etc.).
5. Discard any objects that may penetrate your skin upon impact (or hit you, such as cameras).
6. Tighten your seatbelt and shoulder harnesses.
7. At approximately 2 seconds (~25 feet) above the water, bring your head, neck, and legs in as close to your body as possible. Place your arms along the side of your head, with your hands over the lower back of your head.
8. If experienced, you could execute a full flare and a parachutal-wing stall approximately 3 seconds (~40 feet) above the water (recommended for PPCs with foot steering bars only).
9. Once in the water, release your seatbelt and shoulder harness and exit the cart.
10. Help your passenger with his or her restraints.
11. Do not try to retrieve items on the aircraft or try to save the aircraft. When surfacing, avoid the wing and swim to the side of the PPC (if entangled with the canopy lines, cut them with the line cutter and work your way to the edge of the wing).
12. Swim to shore.

## In-Flight Fire

Considering the flammability of a ram-air wing, it is easy to realize that in-flight fire—especially an engine or fuel fire—is one of the most serious emergencies a PPC pilot can encounter. (Note: An electrical fire in the front of the cart is unlikely to cause anything more than an engine failure. Therefore, see "Engine Failures" above for this specific emergency.) If there is any sign of fire near the engine, fuel containers, or fuel lines, do everything possible to reduce the possibilities of the fire spreading and land as soon as possible. The necessary procedures are:

- Reduce throttle to idle;
- If possible, shut off fuel valves;
- Shut off magnetos;
- Shut off all electronics;
- Land immediately and stop as quickly as possible; and
- Evacuate the aircraft immediately.

After landing, get far away. The principal danger after evacuating the PPC is that the fuel will ignite and explode, with the potential to injure people at considerable distances.

## Landing Porpoise

Porpoising refers to pitch oscillations, most noticeable during a landing. These erratic pilot-induced movements are a result of rapid throttle movements. This is a common, correctable error pilots need to be aware of. There is a delay between throttle changes and pitch changes. Porpoising will result if you over-control the throttle during a landing attempt, causing pitch oscillations. As a result of over-reacting, the PPC, which is now dangerously close to the ground,

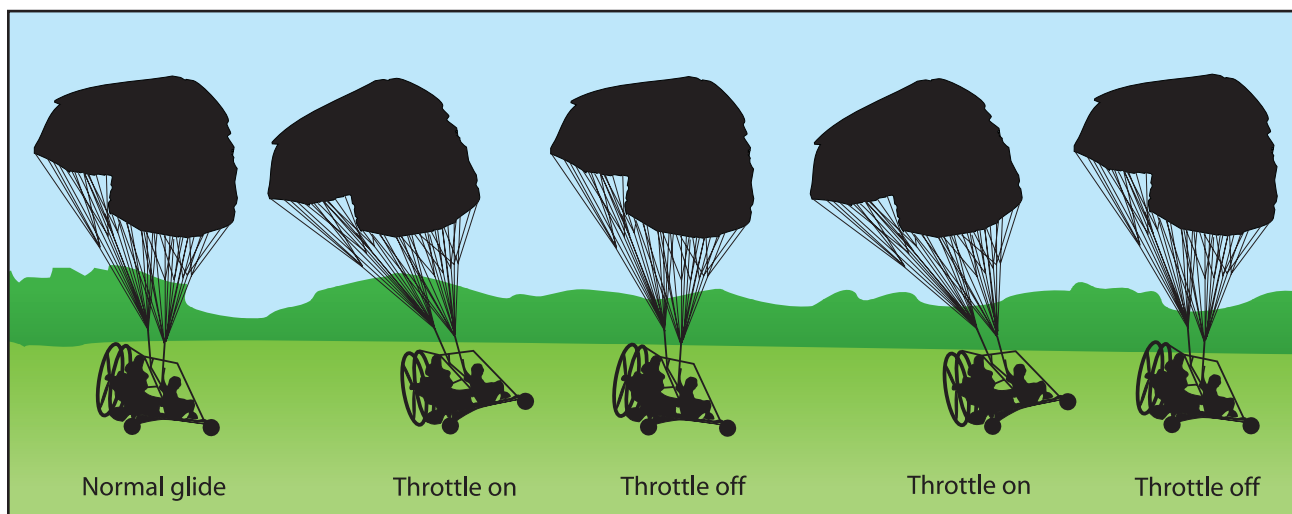

Figure 12-9. Porpoising during a landing approach.

will be further induced into increasing the forward/rearward swinging oscillations from the pilot throttle movements. [Figure 12-9]

If this happens, immediately abort the landing and climb back to pattern altitude. On the next turn to final, relax and work with a slow, smooth throttle action.

## Gust-Induced Oscillations

Gusty headwinds can induce pitch oscillations as the lightweight wing responds faster and more easily to the wind gust than the cart. Crosswinds can also induce side-to-side swing oscillations. A crosswind from the right, for instance, tends to weathervane the PPC wing into the wind, causing an unexpected yaw to the right. Right crosswind gust also tends to lift the upwind side of the wing. When crosswinds are gusty, these effects vary rapidly as the speed of the crosswind varies.

Local terrain can have a considerable effect on the wind. Wind blowing over and around obstacles can be gusty and chaotic. Nearby obstacles, such as buildings, trees, cliffs, and mountains can have a pronounced effect on low altitude winds, particularly on the downwind side of the obstruction. In general, the effect of an upwind obstacle is the creation of additional turbulence. These conditions are usually found from the surface to a height 10 times above the obstacle. Flight in these conditions should be avoided.

Pilot-induced side-to-side swinging can occur as the pilot continues to over-control the steering controls. This usually occurs with new pilots during the landing phase, and typically begins after a side gust of wind during the approach. The solution is similar: relax your steering control pressures; realize the PPC wants to be centered (side to side, as well as fore and aft). Ease the pressure on the steering controls, and let your inputs balance the PPC pendulum movements. [Figure 12-10]

## Cross-Country Flights

Preparation is essential to handling an emergency while on a cross-country flight. Carry your wing bag and line sleeve whenever possible. If you have these items with you during a flight, should you confront unexpected bad weather, you need not consider going around it or fighting it. Simply find a suitable landing site—preferably next to a road. Avoid private property and landing in crops. Pack up your wing and secure the canopy bag to the cart any time you are on

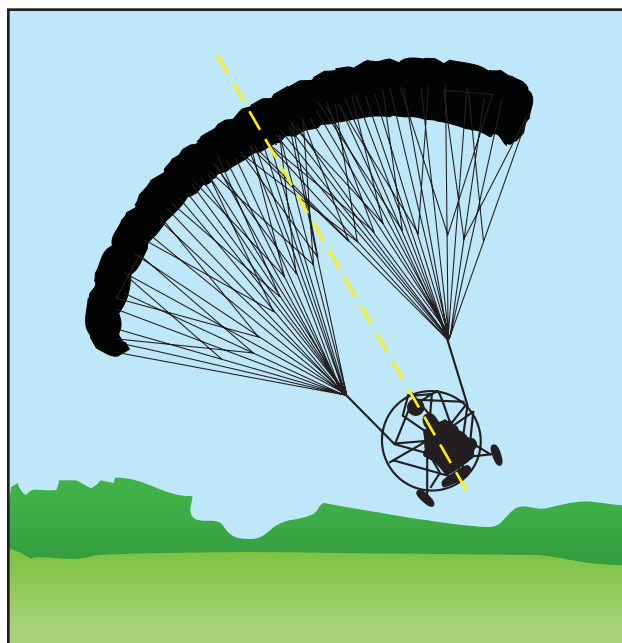

Figure 12-10. Side-to-side swinging on landing approach.

the ground. You then have the option to wait until the weather passes or walk to a phone or shelter.

## Emergency Equipment and Survival Gear

It is a good idea (especially at a fly-in) to circle a new flight park before departing, making a note of the local landmarks, so you can find your field (via pilotage) on your return. Be sure to file, open, and close a flight plan with Flight Service (FSS).

Carry a flight safety kit:

- Flashlight.
- Reflection mirror.
- Water and food (enough for 2 days).
- Matches.
- A utility tool: combo pliers, knife, and so forth.
- Your canopy bag and line sleeve whenever possible—just in case you are forced to drive the cart back to civilization. Note: You should drive the cart to the nearest phone—BUT NO FARTHER.
- Tire repair can which includes a sealer and air pressure.
- Tape to repair small canopy tears. The manufacturer's POH typically has specifications for repairs but as guideline, a tear less than 2" can be repaired with common duct tape. However, cut lines will ground you and hence force you to drive the cart back or walk home.

Communication can be your radio, cell phone, visual, or audible signals. Signal mirrors, flashlight or light beacons at night, signal fire flames at night, sig-

nal smoke during daylight hours, signal flares, and a prominent wing display are effective methods.

Search and rescue squads (SAR) are particularly tuned to signals of threes. Hence, three fires arranged in a triangle, three bangs against a log, or three flashes of a mirror—all of these will initiate a rapid response by search and rescue.

The aviation transceiver can be tuned to broadcast and receive on the emergency frequency 121.5 MHz or any other usable frequency that will elicit a response.

The wing can be employed to lay out a prominent marker to aid recognition from the air by other aircraft. The wing can also be used as an effective layered garment when wrapped around the body to conserve body heat or to provide relief from excessive sunlight.



# Glossary

- 100-HOUR INSPECTION**—An inspection required by 14 CFR 91.409 for FAA-certificated aircraft that are operated for hire, or are used for flight instruction for hire. A 100-hour inspection is similar in content to an annual inspection, but it can be conducted by an aircraft mechanic who holds an Airframe and Powerplant rating, but does not have an Inspection Authorization. A list of the items that must be included in an annual or 100-hour inspection is included in 14 CFR part 43, Appendix D.
- 14 CFR (TITLE 14 OF THE CODE OF FEDERAL REGULATIONS)**—Federal regulations pertaining to aviation activity. Previously known as Federal Aviation Regulations.
- 800-WX-BRIEF**—Phone number for reaching an FAA Flight Service Station 24 hours a day almost anywhere in the United States.
- ABORTED TAKEOFF**—To terminate a replanned takeoff when it is determined that some condition exists which makes takeoff or further flight dangerous.
- ACCELERATION**—Force involved in overcoming inertia, and which may be defined as a change in velocity per unit of time.
- ADM**—See **AERONAUTICAL DECISION MAKING**.
- AERONAUTICAL DECISION MAKING (ADM)**—A systematic approach to the mental process used by pilots to consistently determine the best course of action in response to a given set of circumstances.
- A/FD**—See **AIRPORT/FACILITY DIRECTORY**.
- AFM**—See **AIRCRAFT FLIGHT MANUAL**.
- AIRCRAFT**—A device that is used or intended to be used for flight in the air.
- AIRCRAFT ACCIDENT**—An occurrence associated with the operation of an aircraft which takes place between the time any person boards the aircraft with the intention of flight and all such persons have disembarked, and in which any person suffers death or serious injury, or in which the aircraft receives substantial damage. (NTSB 830.2)
- AIRCRAFT CATEGORIES**—(1) As used with respect to the certification, ratings, privileges, and limitations of airmen, means a broad classification of aircraft. Examples include: powered parachute, airplane, rotorcraft, glider, lighter-than-air, and weight-shift control. (2) As used with respect to the certification of aircraft, means a grouping of aircraft based upon intended use or operating limitations. Examples include: transport, normal, utility, acrobatic, limited, restricted, and provisional.
- AIRCRAFT OPERATING INSTRUCTIONS**—A document developed by the aircraft manufacturer and accepted by the Federal Aviation Administration (FAA). It is specific to a particular make and model powered parachute by serial number and it contains operating procedures and limitations.
- AIRFOIL**—An airfoil is any surface, such as a wing or propeller, which provides aerodynamic force when it interacts with a moving stream of air.
- AIRPORT**—An area of land or water that is used or intended to be used for the landing and takeoff of aircraft, and includes its buildings and facilities, if any.
- AIRPORT/FACILITY DIRECTORY (A/FD)**—A publication of the Federal Aviation Administration containing information on all airports, seaplane bases, and heliports open to the public. The A/FD contains communications data, navigational facilities, and certain special notices and procedures.
- AIRSPACE**—See **CLASS A, CLASS B, CLASS C, CLASS D, CLASS E, or CLASS G AIRSPACE**.
- AIRWORTHINESS**—A state in which an aircraft or component meets the conditions of its type design and is in a condition for safe operation.
- AIRWORTHINESS CERTIFICATE**—A certificate issued by the FAA to aircraft that have been proven to meet the minimum standards set down by the Code of Federal Regulations.
- ALTIMETER**—A flight instrument that indicates altitude by sensing pressure changes.
- AME**—See **AVIATION MEDICAL EXAMINER**.
- ANGLE OF ATTACK (AOA)**—The acute angle between the chord line of the airfoil and the direction of the relative wind.
- ANGLE OF INCIDENCE**—The angle formed by the chord line of the wing and a line parallel to the longitudinal axis of the PPC cart.
- ANNUAL INSPECTION**—A complete inspection of an aircraft and engine, required by the Code of Federal Regulations, to be accomplished every 12 calendar months on all certificated aircraft. Only an A&P technician holding an Inspection Authorization can conduct an annual inspection.



- AOA—See ANGLE OF ATTACK.
- ARM—The horizontal distance in inches from the reference datum line to the center of gravity of an item. Used in weight and loading calculations.
- AROW—The mnemonic aid to remember the certificates and documents required to be onboard an aircraft to determine airworthiness: Airworthiness certificate, Registration certificate, Operating limitations, Weight and balance data.
- ASOS—See AUTOMATED SURFACE OBSERVING SYSTEM.
- ASPECT RATIO—Span of a wing divided by its average chord.
- ASYMMETRICAL AIRFOIL—An airfoil section that is not the same on both sides of the chord line.
- ATIS—See AUTOMATIC TERMINAL INFORMATION SERVICE.
- AUTOMATED SURFACE OBSERVING SYSTEM (ASOS)—Weather reporting system which provides surface observations every minute via digitized voice broadcasts and printed reports.
- AUTOMATED WEATHER OBSERVING SYSTEM (AWOS)—Automated weather reporting system consisting of various sensors, a processor, a computer-generated voice subsystem, and a transmitter to broadcast weather data.
- AUTOMATIC TERMINAL INFORMATION SERVICE (ATIS)—The continuous broadcast (by radio or telephone) of recorded noncontrol, essential but routine, information in selected terminal areas.
- AVIATION MEDICAL EXAMINER (AME)—A medical doctor authorized to perform aviation medical exams for aviators.
- BANK ATTITUDE—The angle of the lateral axis relative to the horizon.
- BASE LEG—A flight path at right angles to the landing runway off its approach end. The base leg normally extends from the downwind leg to the intersection of the extended runway centerline.
- CAMBER—The curvature of a wing when looking at a cross section. A wing has upper camber on its top surface and lower camber on its bottom surface.
- CANOPY—The fabric body of a parachute.
- CARBURETOR ICE—Ice that forms inside the carburetor due to the temperature drop caused by the vaporization of the fuel. Induction system icing is an operational hazard because it can cut off the flow of the fuel/air charge or vary the fuel/air ratio.
- CART—The engine and seats, attached by a structure to wheels; sometimes referred to as the fuselage, cockpit, chaise, or airframe.
- CAVITATION—A condition that exists in a fluid pump when there is not enough pressure in the reservoir to force fluid to the inlet of the pump. The pump picks up air instead of fluid.
- CENTER OF GRAVITY (CG)—The point at which an aircraft would balance if it were possible to suspend it at that point. It is the mass center of the aircraft, or the theoretical point at which the entire weight of the PPC is assumed to be concentrated. It may be expressed in inches from the reference datum, or in percent of mean aerodynamic chord (MAC). The location depends on the distribution of weight in the aircraft.
- CENTER OF LIFT—The location along the chord line of an airfoil at which all the lift forces produced by the airfoil are considered to be concentrated.
- CENTER OF PRESSURE (CP)—The point along the wing chord line where lift is considered to be concentrated.
- CENTRIFUGAL FORCE—The apparent force occurring in curvilinear motion acting to deflect objects outward from the axis of rotation. For instance, when pulling out of a dive, it is the force pushing you down in your seat.
- CENTRIPETAL FORCE—The force in curvilinear motion acting toward the axis of rotation. For instance, when pulling out of a dive, it is the force that the seat exerts on the pilot to offset the centrifugal force.
- CERTIFICATED FLIGHT INSTRUCTOR (CFI)—A flight instructor authorized by the FAA to provide flight instruction in designated category of aircraft.
- CFI—See CERTIFIED FLIGHT INSTRUCTOR.
- CFR—See CODE OF FEDERAL REGULATIONS.
- CG—See CENTER OF GRAVITY.
- CHECKLIST—A list of procedures that provides a logical and standardized method to operate a particular make and model aircraft.
- CHECKRIDE—A practical test administered by an FAA examiner or designated examiner for the purpose of issuing an FAA certificate or rating.
- CHORD LINE—An imaginary straight line drawn through an airfoil from the leading edge to the trailing edge.
- CLASS A AIRSPACE—Airspace from 18,000 feet MSL up to and including FL600, including the airspace overlying the waters within 12 NM of the

coast of the 48 contiguous states and Alaska; and designated international airspace beyond 12 NM of the coast of the 48 contiguous states and Alaska within areas of domestic radio navigational signal or ATC radar coverage, and within which domestic procedures are applied.

**CLASS B AIRSPACE**—Airspace from the surface to 10,000 feet MSL surrounding the nation’s busiest airports in terms of IFR operations or passenger numbers. The configuration of each Class B airspace is individually tailored and consists of a surface area and two or more layers, and is designed to contain all published instrument procedures once an aircraft enters the airspace. For all aircraft, an ATC clearance is required to operate in the area, and aircraft so cleared receive separation services within the airspace.

**CLASS C AIRSPACE**—Airspace from the surface to 4,000 feet above the airport elevation (charted in MSL) surrounding those airports having an operational control tower, serviced by radar approach control, and having a certain number of IFR operations or passenger numbers. Although the configuration of each Class C airspace area is individually tailored, the airspace usually consists of a 5 NM radius core surface area that extends from the surface up to 4,000 feet above the airport elevation, and a 10 NM radius shelf area that extends from 1,200 feet to 4,000 feet above the airport elevation.

**CLASS D AIRSPACE**—Airspace from the surface to 2,500 feet above the airport elevation (charted in MSL) surrounding those airports that have an operational control tower. The configuration of each Class D airspace area is individually tailored, and when instrument procedures are published, the airspace will normally be designed to contain the procedures.

**CLASS E AIRSPACE**—Airspace that is not Class A, Class B, Class C, or Class D, and it is controlled airspace.

**CLASS G AIRSPACE**—Airspace that is uncontrolled, except when associated with a temporary control tower, and has not been designated as Class A, Class B, Class C, Class D, or Class E airspace.

**CODE OF FEDERAL REGULATIONS (CFRs)**—Regulations issued by the U.S. Federal Government as published in the Federal Register.

**COMBUSTION**—Process of burning the fuel/air mixture in the engine in a controlled and predictable manner.

**COMMON TRAFFIC ADVISORY FREQUENCY (CTAF)**—A frequency designed for the purpose

of carrying out airport advisory practices while operating to or from an airport without an operating control tower. The CTAF may be a UNICOM, Multicom, FSS or tower frequency and is identified in appropriate aeronautical publications.

**CONTROLLED AIRSPACE**—An airspace of defined dimensions within which air traffic control service is provided to IFR flights and to VFR flights in accordance with the airspace classification. Note: “controlled airspace” is a generic term that covers Class A, Class B, Class C, Class D and Class E airspace.

**CONTROL TOWER**—A terminal facility that uses air/ground communications, visual signaling, and other devices to provide ATC services to aircraft operating in the vicinity of an airport or on the movement area. Authorizes aircraft to land or takeoff at the airport controlled by the tower or to transit the Class D airspace area regardless of the flight plan or weather conditions. May also provide approach control services (radar or nonradar).

**COORDINATED TURN**—Turn made by an aircraft where the horizontal component of lift is equal to the centrifugal force of the turn.

**CRAB ANGLE**—The angle formed between the direction an aircraft is pointed and the direction it is tracking over the ground resulting from a crosswind component.

**CREWMEMBER**—A person assigned to perform duty in an aircraft during flight time.

**CREW RESOURCE MANAGEMENT (CRM)**—The application of team management concepts in the flight deck environment. This includes single pilots of general aviation aircraft. Pilots of small aircraft, as well as crews of larger aircraft, must make effective use of all available resources; human resources, hardware, and information. Human resource groups include but are not limited to: pilots, dispatchers, cabin crewmembers, maintenance personnel, and air traffic controllers.

**CRM**—See CREW RESOURCE MANAGEMENT.

**CROSSWIND**—Wind blowing across rather than parallel to the direction of flight. In a traffic pattern, the crosswind leg is a flight path at right angles to the landing runway off its upwind end.

**CROSSWIND CORRECTION**—Correction applied in order to maintain a straight ground track during flight when a crosswind is present.

**CROSSWIND LANDING**—Landing made with a wind that is blowing across rather than parallel to the landing direction.

**CROSSWIND TAKEOFFS**—Takeoffs made during crosswind conditions.

- CTAF**—See COMMON TRAFFIC ADVISORY FREQUENCY.
- DATUM**—An imaginary vertical plane or line from which all measurements of moment arm are taken. The datum is established by the manufacturer.
- DECIDE MODEL**—Model developed to help pilots remember the six-step decision-making process: Detect, Estimate, Choose, Identify, Do, Evaluate.
- DECK ANGLE**—The angle of the cart's lower frame (from the front wheel to the rear wheels), to the landing surface.
- DENSITY ALTITUDE**—Pressure altitude corrected for variations from standard temperature. When conditions are standard, pressure altitude and density altitude are the same. If the temperature is above standard, the density altitude is higher than pressure altitude. If the temperature is below standard, the density altitude is lower than pressure altitude. This is an important altitude because it is directly related to the PPC's performance.
- DEPARTURE LEG**—The leg of the rectangular traffic pattern that is a straight course aligned with, and leading from, the takeoff runway.
- DESIGNATED PILOT EXAMINER (DPE)**—An individual designated by the FAA to administer practical tests to pilot applicants.
- DIRECTIONAL STABILITY**—Stability about the vertical axis of an aircraft, whereby an aircraft tends to return, on its own, to flight aligned with the relative wind when disturbed from that equilibrium state. The pendulum design is the primary contributor to directional stability, causing a PPC in flight to align with the relative wind.
- DOWNWIND LEG**—Leg of the traffic pattern flown parallel to the landing runway, but in a direction opposite to the intended landing direction.
- DPE**—See DESIGNATED PILOT EXAMINER.
- DRAG**—An aerodynamic force on a body acting parallel and opposite to the relative wind. The resistance of the atmosphere to the relative motion of an aircraft. Drag opposes thrust and limits the speed of the aircraft.
- DRAG COEFFICIENT (Cd)**—A dimensionless number used to define the amount of total drag produced by an aircraft.
- DRIFT CORRECTION**—Correction that is applied to counter the effects of wind on an aircraft's flight and ground track.
- DUAL FLIGHT**—Flight time that is received and logged as training time. Dual flight time must be endorsed by a Certificated Flight Instructor.
- DYNAMIC PRESSURE (q)**—The pressure a moving fluid would have if it were stopped. Reference 14 CFR 61.51(h).
- EIS**—See ENGINE INFORMATION SYSTEM.
- E-LSA (EXPERIMENTAL LIGHT-SPORT AIRCRAFT)**—An aircraft issued an experimental certificate under Title 14 of the Code of Federal Regulations (14 CFR) part 21.
- EMERGENCY FREQUENCY**—Frequency that is used by aircraft in distress to gain ATC assistance. 121.5 MHz is an international emergency frequency guarded by Flight Service Stations and some military and civil aircraft. Reference AIM paragraph 6-3-1.
- ERROR CHAIN**—A series of mistakes that may lead to an accident or incident. Two basic principles generally associated with the creation of an error chain are: (1) one bad decision often leads to another; and (2) as a string of bad decisions grows, it reduces the number of subsequent alternatives for continued safe flight. Aeronautical decision making is intended to break the error chain before it can cause an accident or incident.
- FAA**—See FEDERAL AVIATION ADMINISTRATION.
- FAA INSPECTOR**—FAA personnel who can administer practical and proficiency tests and can issue pilot certificates.
- FAA KNOWLEDGE EXAM**—Written exam administered by the FAA as a prerequisite for pilot certification. Passing the knowledge and practical exams are required for pilot applicants to be issued FAA certificates or ratings.
- FAR**—See FEDERAL AVIATION REGULATIONS.
- FDC NOTICE TO AIRMAN (NOTAM)**—Notice to Airman that is regulatory in nature.
- FEDERAL AVIATION ADMINISTRATION (FAA)**—The federal agency responsible to promote aviation safety through regulation and education.
- FEDERAL AVIATION REGULATIONS (FARs)**—The division within the Department of Transportation of the United States government that has the responsibility of promoting safety in the air, by both regulation and education.
- FIELD ELEVATION**—The highest point of an airport's usable runways measured in feet from mean sea level.
- FINAL**—Leg of the traffic pattern that is a descending flightpath starting from the completion of the base-to-final turn and extending to the point of touchdown.

- FIXED-PITCH PROPELLERS**—Propellers with fixed blade angles. Fixed-pitch propellers are designed as climb propellers, cruise propellers, or standard propellers.
- FIXED-WING AIRCRAFT**—An aircraft whose wing is rigidly attached to the structure. The term fixed-wing is used to distinguish these aircraft from rotary-wing aircraft, such as helicopters and autogiros.
- FLARE**—The slow, smooth transition from a normal approach attitude to a landing attitude. This maneuver is accomplished in a PPC by pulling down on the steering lines to increase drag, reducing the forward speed and decreasing the rate of descent.
- FLIGHT PLAN**—Specified information relating to the intended flight of an aircraft that is filed orally or in writing with an FSS or an ATC facility.
- FOUR FORCES**—The four fundamental forces of flight: lift, weight, drag and thrust.
- FOUR-STROKE ENGINE**—The principle of operation for some reciprocating engines involving the conversion of fuel energy into mechanical energy. The strokes are called intake, compression, power, and exhaust.
- FSS**—FAA Flight Service Station.
- GLIDEPATH**—The path of an aircraft relative to the ground while approaching a landing.
- GLIDE RATIO**—The ratio of the forward distance traveled to the vertical distance an aircraft descends when it is operating without power. For example, an aircraft with a glide ratio of 10:1 will descend about 1,000 feet for every 2 miles (10,560 feet) it moves forward.
- G LOADS**—Loads imposed on an airframe due to inertia (centrifugal force). 1G of load factor represents the weight of the actual aircraft. 2G represents effectively twice the aircraft's actual weight.
- GLOBAL POSITION SYSTEM (GPS)**—A satellite-based radio positioning, navigation, and time-transfer system.
- GO-AROUND**—The termination of a landing approach. Reference the AIM Pilot/Controller Glossary.
- GO OR NO-GO DECISION**—Decision of whether or not to make a flight based on environmental, personal or mechanical factors. A focus area for human factors study.
- GPS**—See GLOBAL POSITION SYSTEM.
- GROUND-ADJUSTABLE PROPELLER**—A type of aircraft propeller whose blade pitch angle can be adjusted when the engine is not running. The adjustment requires loosening the blades in the hub.
- GROUND EFFECT**—A condition of improved performance encountered when an airfoil is operating very close to the ground. When an airfoil is under the influence of ground effect, there is a reduction in upwash, downwash, and wingtip vortices. As a result of the reduced wingtip vortices, induced drag is reduced.
- GROUNDSPEED (GS)**—The actual speed of an aircraft over the ground. It is true airspeed adjusted for wind. Groundspeed decreases with a headwind, and increases with a tailwind.
- GROUND TRACK**—The aircraft's path over the ground when in flight.
- HAZARDOUS INFLIGHT WEATHER ADVISORY SERVICE (HIWAS)**—Recorded weather forecasts broadcast to airborne pilots over selected VORs.
- HEADWIND**—A wind which blows from the direction the aircraft is flying. The ground speed of an aircraft (the speed the aircraft is moving over the ground) is less than the speed through the air by the velocity of the headwind.
- HIWAS**—See HAZARDOUS INFLIGHT WEATHER ADVISORY SERVICE.
- HOUR METER**—An instrument installed in many aircraft to show the actual number of hours the engine has operated. The hour meter is an electrical clock that starts when the engine oil pressure builds up, and runs until the engine is shut down and the oil pressure drops to zero.
- HYPERVENTILATION**—Occurs when an individual is experiencing emotional stress, fright, or pain, and the breathing rate and depth increase, although the carbon dioxide level in the blood is already at a reduced level. The result is an excessive loss of carbon dioxide from the body, which can lead to unconsciousness due to the respiratory system's overriding mechanism to regain control of breathing.
- HYPOXIA**—State of oxygen deficiency in the body sufficient to impair functions of the brain and other organs.
- IFR**—See INSTRUMENT FLIGHT RULES.
- INCIDENT**—An occurrence other than an accident, associated with the operation of an aircraft, which affects or could affect the safety of operations.
- INDUCED DRAG**—That part of total drag which is created by the production of lift. Induced drag increases with a decrease in airspeed.
- INSTRUMENT FLIGHT RULES (IFR)**—Rules governing the procedures for conducting instrument flight. Also a term used by pilots and controllers to indicate type of flight plan.

- INTERFERENCE DRAG**—Type of drag produced by placing two objects adjacent to one another. Combines the effects of form drag and skin friction.
- INVERSION**—An increase in temperature with altitude.
- JUDGMENT**—The mental process of recognizing and analyzing all pertinent information in a particular situation, a rational evaluation of alternative actions in response to it, and a timely decision on which action to take.
- KINESTHESIA**—The sensing of movements by feel.
- KITE**—To pressurize and raise the wing overhead the PPC cart.
- KITING**—Taxiing the PPC on the ground with the wing inflated and overhead.
- KNOWLEDGE EXAM**—See FAA KNOWLEDGE EXAM.
- LATERAL AXIS**—An imaginary line passing through the center of gravity of a PPC and extending across the PPC from one side of the aircraft to the other side.
- LEADING EDGE**—The part of an airfoil that meets the airflow first.
- LIFT**—One of the four main forces acting on an aircraft. On a powered parachute, an upward force created by the effect of airflow as it passes over and under the wing.
- LIGHT-SPORT AIRCRAFT (LSA)**—An aircraft that meets the requirements defined in 14 CFR 1.1, regardless of airworthiness certification.
- LINE-OVERS**—A dangerous situation when the suspension line goes over the top of the wing instead of going straight from the wing to the riser system. This condition will prevent proper inflation of the wing.
- LINE TWISTS**—When the PPC suspension lines on both sides of the wing are spiraled together. Flying with a line twist is unsafe; the wing is unairworthy until it is corrected.
- LOC**—A preflight check: L – Lines Free, O – Cells Open, C – Wing Centered.
- LOGBOOK**—A record of activities: flight, instruction, inspection and maintenance. Reference 14 CFR 43, 14 CFR 61.51, and 14 CFR 91.417.
- LONGITUDINAL AXIS**—An imaginary line through an aircraft from nose to tail, passing through its center of gravity. The longitudinal axis is also called the roll axis of the aircraft.
- LSA**—See LIGHT-SPORT AIRCRAFT.
- MAC**—See MEAN AERODYNAMIC CHORD.
- MAGNETO**—A self-contained engine-driven unit that supplies electrical current to the spark plugs.
- MAKE/MODEL**—Refers to the manufacturer and model of a specific aircraft.
- MANEUVERING ALTITUDE**—An altitude above the ground that allows a sufficient margin of height to permit safe maneuvering.
- MAXIMUM GROSS WEIGHT**—The maximum authorized weight of the aircraft and all of its equipment as specified in the TCDS for the aircraft.
- MEAN AERODYNAMIC CHORD (MAC)**—The average distance from the leading edge to the trailing edge of the wing.
- MECHANICAL TURBULENCE**—Type of turbulence caused by obstructions on the ground interfering with smooth flow of the wind. Trees, buildings and terrain can all cause mechanical turbulence.
- MEDICAL CERTIFICATE**—Acceptable evidence of physical fitness on a form prescribed by the Administrator.
- MEDIUM-BANKED TURN**—Turn resulting from a degree of bank (approximately 20 to 45 degrees) at which the PPC remains at a constant bank.
- MILITARY TRAINING ROUTES (MTR)**—Special routes developed to allow the military to conduct low-altitude, high speed training.
- MILITARY OPERATIONS AREA (MOA)**—Air-space of defined vertical and lateral limits established for the purpose of separating certain military training activity from IFR traffic.
- MINDSET**—A factor in aeronautical decision making where decision making is influenced by preconceived ideas about the outcome of events. For example, an expectation of improving weather conditions can lead to increased risk during a flight.
- MOA**—See MILITARY OPERATIONS AREA.
- MODE C TRANSPONDER**—A receiver/transmitter which will generate a radar reply signal upon proper interrogation; the interrogation and reply being on different frequencies. Mode C means the reply signal includes altitude information.
- MOMENT**—A force that causes or tries to cause an object to rotate. The product of the weight of an item multiplied by its arm. Moments are expressed in pound-inches (lb-in). Total moment is the weight of the PPC multiplied by the distance between the datum and the CG.
- NEWTON'S THIRD LAW OF MOTION**—Whenever one body exerts a force on another, the sec-

- ond body always exerts on the first, a force that is equal in magnitude but opposite in direction.
- NONTOWERED AIRPORTS**—An airport without an operating control tower.
- NOTAM (NOTICE TO AIRMEN)**—A notice containing information concerning facilities, services, or procedures, the timely knowledge of which is essential to personnel concerned with flight operations.
- OPERATING LIMITATIONS**—Limitations published by aircraft manufacturers to define limitations on maneuvers, flight load factors, speeds and other limits. Presented in the aircraft in the form of placards and printed in the limitations section of the aircraft flight manual.
- OVERSHOOTING**—The act of over flying an intended spot for landing or flying through a course intended for intercept.
- PARAFOIL**—See RAM-AIR WING.
- PARALLEL RUNWAYS**—Two or more runways at the same airport whose centerlines are parallel. In addition to runway number, parallel runways are designated as L(left) and R(right) or if three parallel runways exist, L(left), C (center) and R(right).
- PARASITE DRAG**—That part of total drag created by the design or shape of PPC parts. Parasite drag increases with an increase in airspeed.
- PART 1**—Federal Aviation Regulation from 14 CFR, pertaining to definitions and abbreviations of terms.
- PART 61**—Federal Aviation Regulation from 14 CFR, pertaining to the issuance of pilot and instructor certificates and ratings.
- PART 67**—Federal Aviation Regulation from 14 CFR, pertaining to medical standards and certification for pilots.
- PART 91**—Federal Aviation Regulation from 14 CFR, pertaining to general operating and flight rules.
- PATTERN ALTITUDE**—The common altitude used for aircraft maneuvering in the traffic pattern. Usually 1,000 above the airport surface.
- PENDULUM**—A body so suspended from a fixed point as to move to and fro by the action of gravity and acquired momentum.
- PENDULUM EFFECT**—The characteristic of the cart weight hanging below the wing that stabilizes the wing pitching moment and the cart underneath the wing for unaccelerated flight. This cart weight (pendulum) can also create momentum of the cart rotating around the wing.
- PERSONALITY TENDENCIES**—Personal traits and characteristics of an individual that are set at a very early age and extremely resistant to change.
- P-FACTOR**—A tendency for an aircraft to yaw to the left due to the descending propeller blade on the right producing more thrust than the ascending blade on the left. This occurs when the aircraft's longitudinal axis is in a climbing attitude in relation to the relative wind. The P-factor would be to the right if the aircraft had a counterclockwise rotating propeller.
- PILOTAGE**—Navigational technique based on flight by reference to ground landmarks.
- PILOT IN COMMAND**—The pilot responsible for the operation and safety of an aircraft.
- PILOT'S OPERATING HANDBOOK (POH)**—A document developed by the aircraft manufacturer and contains the FAA approved Aircraft Flight Manual (AFM) information.
- PITCH**—The rotation of a PPC about its lateral axis.
- PITCH ANGLE**—The angle between the wing and the horizontal plane of the earth.
- PITCH ATTITUDE**—The angle of the longitudinal axis relative to the horizon. Pitch attitude serves as a visual reference for the pilot to maintain or change airspeed.
- PLACARDS**—Small statements or pictorial signs permanently fixed in the cockpit and visible to the pilot. Placards are used for operating limitations (e.g., weight or speeds) or to indicate the position of an operating lever (e.g., landing gear retracted or down and locked).
- PLANFORM**—The shape or form of a wing as viewed from above. It may be long and tapered, short and rectangular, or various other shapes.
- POH**—See PILOT'S OPERATING HANDBOOK.
- PORPOISING**—Oscillating around the lateral axis of the aircraft during landing.
- PORPOISING EFFECT**—The rapid increase in throttle resulting in a rapid initial pitch up, which results in the pendulum effect that dampens out into a steady state climb.
- POSITIVE DYNAMIC STABILITY**—The tendency over time for an aircraft to return to a pre-disturbed state.
- POSITIVE STATIC STABILITY**—The initial tendency to return to a state of equilibrium when disturbed from that state.
- POWERED PARACHUTE (PPC)**—A powered aircraft comprised of a flexible or semi-rigid wing connected to a fuselage (cart) so that the wing is not in position for flight until the aircraft is in mo-

- tion. The fuselage of a powered parachute contains the aircraft engine, a seat for each occupant and is attached to the aircraft's landing gear.
- POWER-OFF DESCENT**—Aircraft configuration where a descent occurs with power at idle.
- POWERPLANT**—A complete engine and propeller combination with accessories.
- PPC**—See **POWERED PARACHUTE**.
- PPCL**—Powered parachute land.
- PPCS**—Powered parachute sea.
- PRACTICAL TEST**—Flight test administered by an FAA examiner or designated examiner as a prerequisite for pilot certification. Successful completion of the practical test is required to earn a pilot certificate or rating.
- PRACTICAL TEST STANDARDS (PTS)**—An FAA published document of standards that must be met for the issuance of a particular pilot certificate or rating. FAA inspectors and designated pilot examiners use these standards when conducting pilot practical tests, and flight instructors use the PTS while preparing applicants for practical tests.
- PREFLIGHT INSPECTION**—Aircraft inspection conducted to determine if an aircraft is mechanically and legally airworthy.
- PRESSURE ALTITUDE**—The altitude indicated when the altimeter setting window (barometric scale) is adjusted to 29.92. This is the altitude above the standard datum plane, which is a theoretical plane where air pressure (corrected to 15°C) equals 29.92 in. Hg. Pressure altitude is used to compute density altitude, true altitude, true airspeed, and other performance data.
- PRIVATE AIRPORT**—Airport that is privately owned and not available to the public without prior permission. They are depicted on aeronautical charts for emergency and landmark purposes.
- PRIVATE PILOT CERTIFICATE**—An FAA-issued pilot certificate permitting carriage of passengers on a not-for-hire basis. Reference 14 CFR part 61.
- PROFICIENCY CHECK**—An evaluation of aeronautical knowledge and flight proficiency. Reference part 61. Upon successful completion of the proficiency check the authorized instructor will endorse the applicant's logbook indicating the added category/class of equipment that the applicant is authorized to operate.
- PROPELLER**—A device for propelling an aircraft that, when rotated, produces by its action on the air, a thrust approximately perpendicular to its plane of rotation. It includes the control components normally supplied by its manufacturer.
- PROPELLER BLAST**—The volume of air accelerated behind a propeller producing thrust.
- PTS**—See **PRACTICAL TEST STANDARDS**.
- PUBLIC AIRPORT**—Airport that is available to the aviation public.
- PUSHER CONFIGURATION**—Propeller configuration where the propeller shaft faces the rear of the aircraft. Thrust produced by the propeller pushes the aircraft, rather than pulling it.
- RAM-AIR WING**—Also known as a parafoil. An airfoil designed with an aerodynamic cell structure which is inflated by the wind, forming a classic wing cross-section that generates lift.
- RECIPROCATING ENGINE**—An engine that converts the heat energy from burning fuel into the reciprocating movement of the pistons. This movement is converted into a rotary motion by the connecting rods and crankshaft.
- REGISTRATION CERTIFICATE**—A federal certificate that documents aircraft ownership.
- RELATIVE WIND**—The direction the wind strikes an airfoil.
- RIBS**—The parts of an aircraft wing structure that give the wing its aerodynamic cross section. Fabric covers the ribs and gives the PPC wing its airfoil shape.
- RISERS**—One of several straps that attach the cart to the suspension lines. Sometimes referred to as "V lines," risers are the intermediate link between the suspension lines and the aircraft.
- RISK ELEMENTS**—The four fundamental areas of exposure to risk: the pilot, the aircraft, the environment, and the type of operation that comprise any given aviation situation.
- RISK MANAGEMENT**—The part of the decision making process which relies on situational awareness, problem recognition, and good judgment to reduce risks associated with each flight.
- ROLL**—The rotation of an aircraft about its longitudinal axis.
- ROUNDOUT (FLARE)**—A pitch-up during landing approach to reduce rate of descent and forward speed prior to touchdown.
- RPM**—Revolutions per minute. A measure of rotational speed. One RPM is one revolution made in one minute.
- RUNWAY**—A defined rectangular area on a land airport prepared for the landing and takeoff run of aircraft along its length. Runways are normally numbered in relation to their magnetic direction rounded off to the nearest 10 degrees; e.g., Runway 1, Runway 25.

- RUNWAY INCURSION**—Any occurrence at an airport involving an aircraft, vehicle, person, or object on the ground that creates a collision hazard or results in loss of separation with an aircraft taking off, intending to takeoff, landing, or intending to land.
- SAR**—See **SEARCH AND RESCUE**.
- SCANNING**—Systematic means of searching for other aircraft. Scanning is most effective when successive areas of the sky are brought into focus using a series of short, regularly spaced eye movements.
- SEARCH AND RESCUE (SAR)**—A lifesaving service provided through the combined efforts of the federal agencies signatory to the National SAR plan along with state agencies.
- SECTIONAL AERONAUTICAL CHARTS**—Designed for visual navigation of slow or medium speed aircraft. Topographic information on these charts features the portrayal of relief, and a judicious selection of visual check points for VFR flight. Aeronautical information includes visual and radio aids to navigation, airports, controlled airspace, restricted areas, obstructions and related data.
- SEE AND AVOID**—When weather conditions permit, pilots operating IFR or VFR are required to observe and maneuver to avoid other aircraft. Right-of-way rules are contained in 14 CFR part 91.
- SEGMENTED CIRCLE**—A visual indicator around a windsock or tetrahedron designed to show the traffic pattern for each runway.
- SHALLOW-BANKED TURN**—Turns in which the bank (less than approximately 20 degrees) is so shallow that inherent lateral stability of the PPC is acting to level the wings unless the pilot maintains the bank.
- SINGLE PILOT RESOURCE MANAGEMENT (SRM)**—Area of human factors study that addresses application of management skills in the cockpit. Single pilots of small aircraft must make effective use of all available resources; human resources, hardware, and information.
- SITUATIONAL AWARENESS**—The accurate perception and understanding of all the factors and conditions within the four fundamental risk elements that affect safety before, during, and after the flight.
- SKILLS AND PROCEDURES**—The procedural, psychomotor, and perceptual skills used to control a specific aircraft or its systems. They are the airmanship abilities that are gained through conventional training, are perfected, and become almost automatic through experience.
- SKIN**—The outside covering of an aircraft airframe.
- SKIN FRICTION DRAG**—The type of parasite drag resulting from a rough surface which deflects the streamlines of air on the surface, causing resistance to smooth airflow.
- S-LSA (SPECIAL LIGHT-SPORT AIRCRAFT)**—An aircraft issued a special airworthiness certificate in accordance with 14 CFR 21.290 in the light-sport category. These aircraft meet the ASTM industry-developed consensus standards.
- SOLO FLIGHT**—Flight that is conducted and logged when a pilot is the sole occupant of an aircraft.
- SPATIAL DISORIENTATION**—Specifically refers to the lack of orientation with regard to the position, attitude, or movement of the PPC in space.
- SPECIAL USE AIRSPACE**—Airspace that exists where activities must be confined because of their nature.
- SPORT PILOT CERTIFICATE**—An FAA-issued pilot certificate, allowing the holder to operate a light-sport aircraft in the category, class, make and model for which they are endorsed to do so.
- SRM**—See **SINGLE PILOT RESOURCE MANAGEMENT**.
- STABILIZED APPROACH**—A landing approach in which the pilot establishes and maintains a constant angle glidepath towards a predetermined point on the landing runway. It is based on the pilot's judgment of certain visual cues, and depends on the maintenance of a constant final descent airspeed and configuration.
- STALL**—A rapid decrease in lift caused by the separation of airflow from the wing's surface brought on by exceeding the critical angle of attack. A stall can occur at any pitch attitude or airspeed.
- STANDARD AIRPORT TRAFFIC PATTERN**—The left-hand turn traffic flow that is prescribed for aircraft landing at, taxiing on, or taking off from an airport. Reference 14 CFR 91.126 (a)(1) and AIM Chapter 4 Section 3.
- STATIC PRESSURE**—The pressure of air that is still, or not moving, measured perpendicular to the surface exposed to the air.
- STEEP TURN**—Turn resulting from a degree of bank (45 degrees or more) at which the overbanking tendency of a PPC overcomes stability, and the bank increases unless the steering controls are applied to prevent it.
- STEERING BARS**—Located just aft of the nose-wheel and mounted on each side of the aircraft,



- the steering bars move forward and back when the pilot applies foot pressure. Pushing either one of the steering bars causes the steering lines to pull down on the corresponding surface of the trailing edge on the wing which banks the PPC into a turn.
- STEERING LINES**—Connected to the steering bars and routed through pulleys up to the trailing edge of the parachute.
- STRAIGHT-IN APPROACH**—Entry into the traffic pattern by interception of the extended runway centerline (final approach course) without executing any other portion of the traffic pattern.
- STRESS MANAGEMENT**—The personal analysis of the kinds of stress experienced while flying, the application of appropriate stress assessment tools, and other coping mechanisms.
- STROBE**—A high intensity white flashing light. Strobe lights are located on aircraft wingtips to increase aircraft visibility in low light conditions.
- STUDENT PILOT CERTIFICATE**—An FAA-issued certificate that permits student pilots to exercise solo pilot privileges with limitations. A student's medical becomes their student pilot certificate once it is endorsed by their flight instructor.
- SUSPENSION LINES**—Lines that run from several attachment points on the wing down to a set of cables called risers, which connect to the PPC cart.
- TAILWIND**—Wind blowing in the same direction the aircraft is moving. When an aircraft is flying with a tailwind, its speed over the ground is equal to its speed through the air, plus the speed the air is moving over the ground.
- TAKEOFF CLEARANCE**—ATC authorization for an aircraft to depart a runway. It is predicated on known traffic and known physical airport conditions.
- TAXI**—The movement of an aircraft under its own power while on the ground.
- TAXIWAY**—Airport area designated for aircraft surface movement.
- TEMPORARY FLIGHT RESTRICTION (TFR)**—Designated airspace of specified dimension where flight is temporarily restricted or prohibited. NOTAMs are issued to advise airmen of local TFR restrictions.
- TERMINAL RADAR SERVICE AREAS (TRSA)**—Areas where participating pilots can receive additional radar services. The purpose of the service is to provide separation between all IFR operations and participating VFR aircraft.
- TFR**—See TEMPORARY FLIGHT RESTRICTION.
- THERMAL**—A buoyant plume or bubble of rising air.
- THROTTLE**—The control in an aircraft that regulates the power or thrust the pilot wants the engine to develop.
- THRUST**—The force which imparts a change in the velocity of a mass. A forward force which propels the powered parachute through the air.
- TORQUE**—(1) A resistance to turning or twisting. (2) Forces that produce a twisting or rotating motion. (3) In a PPC, the tendency of the aircraft to turn (roll) in the opposite direction of rotation of the engine and propeller.
- TOTAL DRAG**—The sum of the parasite and induced drag.
- TOUCH AND GO**—An operation by an aircraft that lands and takes off without stopping.
- TOUCHDOWN POINT**—The point or intended point at which an aircraft first makes contact with the landing surface.
- TOUCHDOWN ZONE**—The portion of a runway, beyond the threshold, where it is intended landing aircraft first contact the runway.
- TRACK**—The actual path made over the ground in flight.
- TRAFFIC PATTERN**—The traffic flow that is prescribed for aircraft landing at or taking off from an airport.
- TRAFFIC PATTERN INDICATORS**—Ground based visual indicators that identify traffic pattern direction at certain airports.
- TRAILING EDGE**—The portion of the airfoil where the airflow over the upper surface rejoins the lower surface airflow.
- TRANSPONDER**—The airborne portion of the secondary surveillance radar system. The transponder emits a reply when queried by a radar facility.
- TRICYCLE GEAR CONFIGURATION**—Landing gear configuration employing a third wheel located on the nose of the aircraft.
- TRSA**—See TERMINAL RADAR SERVICE AREAS.
- TWO-STROKE ENGINE**—A simple form of reciprocating engine that completes its operating cycle in two strokes of its piston—one down and one up. Two-stroke-cycle engines are inefficient in their use of fuel, but their simplicity makes them popular for powering light-sport aircraft and ultralight vehicles where light weight and low cost are paramount.

- ULTRALIGHT**—A vehicle as defined by 14 CFR 103.1.
- UNSTABILIZED APPROACH**—The final approach of an aircraft that has not achieved a stable rate of descent or controlled flight track by a pre-determined altitude, usually 500 feet AGL.
- UPWIND LEG**—A flight path parallel to the landing runway in the direction of landing.
- VEHICLE**—Man-made means of transportation; an ultralight aircraft (not a light-sport aircraft).
- VENTURI**—A specially shaped restriction in a tube designed to speed up the flow of fluid passing through in accordance with Bernoulli's principle. Venturis are used in carburetors and in many types of fluid control devices to produce a pressure drop proportional to the speed of the fluid passing through them.
- VENTURI EFFECT**—The effect of Bernoulli's principle, which states that the pressure of a fluid decreases as it is speeded up without losing or gaining any energy from the outside.
- VERIFIED**—Confirmation of information or configuration status.
- VERTICAL AXIS (YAW)**—An imaginary line passing vertically through the center of gravity of an aircraft. The vertical axis is called the z-axis or the yaw axis.
- VERTICAL SPEED INDICATOR (VSI)**—An instrument that uses static pressure to display a rate of climb or descent in feet per minute. The VSI can also sometimes be called a vertical velocity indicator (VVI).
- VERTIGO**—A type of spatial disorientation caused by the physical senses sending conflicting signals to the brain. Vertigo is especially hazardous when flying under conditions of poor visibility and may cause pilot incapacitation, but may be minimized by confidence in the indication of the flight instruments.
- VFR**—See VISUAL FLIGHT RULES.
- VFR TERMINAL AREA CHARTS**—Charts designated to depict Class B airspace in greater detail and greater scale than sectional charts.
- VISUAL FLIGHT RULES (VFR)**—Code of Federal Regulations that govern the procedures for conducting flight under visual conditions.
- V LINES**—See RISERS.
- VSI**—See VERTICAL SPEED INDICATOR.
- WAKE TURBULENCE**—Wingtip vortices that are created when an aircraft generates lift. When an aircraft generates lift, air spills over the wingtips from the high pressure areas below the wings to the low pressure areas above them. This flow causes rapidly rotating whirlpools of air called wingtip vortices or wake turbulence.
- WASHOUT**—A condition in aircraft rigging in which a wing is twisted so its angle of incidence is less at the tip than at the root. Washout decreases the lift the wing produces to improve the stall characteristics of the wing.
- WEATHER BRIEFING**—Means for pilots to gather all information vital to the nature of the flight. Most often obtained from FSS specialist.
- WEATHERVANE**—The tendency to point into the wind.
- WEIGHT**—A measure of the heaviness of an object. The force by which a body is attracted toward the center of the Earth (or another celestial body) by gravity. Weight is equal to the mass of the body times the local value of gravitational acceleration. One of the four main forces acting on an aircraft. Equivalent to the actual weight of the aircraft. It acts downward through the aircraft's center of gravity toward the center of the Earth. Weight opposes lift.
- WEIGHT-SHIFT CONTROL AIRCRAFT**—Powered aircraft with a framed pivoting wing and a fuselage controllable only in pitch and roll by the pilot's ability to change the aircraft's center of gravity with respect to the wing. Flight control of the aircraft depends on the wing's ability to flexibly deform rather than the use of control surfaces.
- WIND CORRECTION ANGLE**—Correction applied to the course to establish a heading so that track will coincide with course.
- WIND DIRECTION INDICATORS**—Indicators that include a wind sock, wind tee, or tetrahedron. Visual reference will determine wind direction and runway in use.
- WIND DRIFT CORRECTION**—Correction applied to the heading of the aircraft necessary to keep the aircraft tracking over a desired track.
- WIND SHEAR**—A sudden, drastic shift in wind-speed, direction, or both that may occur in the horizontal or vertical plane.
- WING**—A ram-air inflated and pressurized fabric airfoil that produces the lift necessary to support the powered parachute in flight; including the lines that attach to the cart. Also called a parachute, chute, or airfoil.
- WING LOADING**—The amount of weight that a wing must support to provide lift.
- WINGSPAN**—The maximum distance from wingtip to wingtip.



# Index

## Symbols

100-hour inspection .....	5-5
14 CFR part 103.....	1-1

## A

accidents.....	7-2, 10-1, 11-6, 12-2
adjustable front seat .....	3-1
ADM .....	1-4
aerodynamics .....	2-16
aeronautical decision making.....	1-4
after-landing roll .....	11-6
aiming point .....	11-7
air-cooled engine.....	3-3
air cooling .....	4-13
airfoil.....	2-1
airfoil shape.....	3-5
airframes .....	3-1
Airport/Facility Directory (A/FD) .....	5-2, 10-3
airport advisory area .....	8-5
airport lighting, markings.....	10-2
airport management .....	5-2
airports .....	10-1, 10-2
airport signs.....	10-5
airport traffic pattern .....	9-4
air powered.....	1-1
airsickness .....	1-7
airspace .....	8-1
airspeed .....	2-8, 10-1
airworthiness .....	5-5
airworthiness certificate .....	1-2
alcohol.....	1-6
alert areas .....	8-5
alternate airport .....	12-1
altitude.....	6-7, 9-1
ammeter.....	3-4
analog gauges.....	3-3
angle of attack .....	2-1, 2-12, 6-1
angle of bank.....	9-4
angle of incidence .....	2-1
angle of trim.....	6-1
annual inspection .....	5-5
anti-collision strobe lights.....	12-1
anxiety.....	1-6
approaches and landings, faulty .....	11-11
AROW.....	5-5
aspect ratio .....	2-2
attachment point bracket.....	3-3
attachment points .....	3-2
attitude.....	6-3
attitude flying .....	6-3
attitude management .....	1-4
auto gas .....	4-11

automatic terminal information service (ATIS).....	10-3
auxiliary fuel pump.....	4-8
AVGAS .....	4-11

## B

balance .....	5-3
base leg.....	10-5, 11-1
basic flight maneuvers.....	6-1
basic weather minimums.....	8-2
battery .....	3-4
before takeoff check.....	7-3
bouncing.....	11-11
brakes .....	3-2, 5-6, 5-11
braking the wing .....	3-5

## C

camber.....	2-1
canopy .....	1-1, 2-3
capacitance discharger system (CDI).....	4-9
carburetor .....	4-6
carburetor icing .....	4-8
cart.....	1-2
cart inspection .....	5-6
cell openings .....	7-6
centering the wing.....	7-6
center of gravity .....	2-8, 3-2
centrifugal clutch .....	4-6
Certificate Eligibility Requirements .....	1-2
certificates and documents .....	5-5
certified flight instructor.....	1-3
CFI .....	1-3
CFRs .....	1-3
CG .....	2-8, 3-2
CG tubes.....	3-3
checklists.....	1-5, 5-5
checkride.....	1-3
choke .....	4-10
chord line .....	2-1
chute.....	1-2
circuit breakers.....	3-4
class A airspace .....	8-1
class B airspace .....	8-2
class C airspace .....	8-3
class D airspace.....	8-3
class E airspace .....	8-3
class G airspace.....	8-4
clearing turns.....	6-2, 9-1
climbs.....	6-7, 7-1
clouds .....	5-3, 5-4
cockpit management .....	7-2
Code of Federal Regulations.....	1-3
collision avoidance.....	3-3, 9-1
combustion .....	4-9
common traffic advisory frequency (CTAF).....	5-11, 10-1, 10-3
communication requirements.....	10-2
communication requirements, airspace operations .....	8-3

complacency .....	12-2
controlled airspace .....	8-1, 8-6
controlled firing areas .....	8-5
control towers.....	10-2
critical angle of attack.....	2-14
cross-country flights.....	12-8
cross-port openings .....	2-3
crosswind .....	10-1, 11-6
crosswind landings.....	5-3
crosswind leg .....	10-6
crosswind takeoffs.....	5-2, 5-3, 7-6

## D

da Vinci, Leonardo .....	1-1
decision-making process.....	1-4
deck angle .....	2-1
dehydration .....	1-6
density altitude.....	5-3, 7-9
departure area.....	5-2
departure leg.....	10-6
descent.....	6-7
descent angle.....	11-2
detonation.....	4-9
documentation.....	5-5
downwind leg .....	10-4
drag .....	2-5, 2-6
drift correction .....	11-1
driver’s license .....	5-5
drogue chute.....	7-7
drugs.....	1-6
dual controls.....	1-2
dual flight controls .....	3-1
dual ignition .....	4-1
dual ignition system .....	4-9
dynamic pendulum effect.....	2-10, 2-14

## E

EGT.....	4-4
EIS.....	3-3
electrical system.....	3-4, 4-1
elliptical.....	2-2
emergency approaches and landings.....	11-9
emergency situations.....	12-1
endorsements.....	5-5
engine.....	3-8
engine cooling systems .....	4-13
engine failure .....	7-7, 12-5, 12-6
engine information system.....	3-3
engine inspections.....	4-1
engine start .....	5-9, 7-3
engine warm-up .....	5-10
engine warming.....	4-4
environment .....	12-2
equipment requirements.....	3-4
equipment requirements, airspace operations .....	8-3
equipment staging .....	7-1
error chain .....	1-4

exhaust gas temperature.....	4-4
exhaust pipe .....	4-4
exhaust system .....	4-4, 5-9

## F

FAA Knowledge Exam .....	1-3
Farrand, Lowell.....	1-1
fatigue .....	1-7
feel of the powered parachute .....	6-8
feel of the PPC .....	6-2
final approach.....	11-2
final approach leg.....	10-5
fixed-pitch propeller.....	4-6
fixed-wing aircraft.....	10-1
flare .....	2-13, 6-5, 7-8, 11-4, 11-5
flaring .....	3-5
flight computer.....	3-3
flight controls .....	6-1
flight diversion .....	12-1
flight over U.S. parks and forest service areas, etc. ....	8-6
flight path .....	2-1
flight safety kit .....	12-8
flight training.....	1-3
fog .....	5-3
forced-landing fields .....	9-2
four-stroke engines.....	4-4
four forces .....	2-4
four fundamentals .....	6-1
fuel .....	3-7, 4-11, 5-8
fuel contamination .....	4-12
fuel filter.....	4-11
fuel gauges .....	4-11
fuel injection .....	4-8
fuel level probes .....	3-8
fuel shut-off valve .....	3-8
fuel system .....	4-10
fuel tanks.....	3-7
fuel venting system .....	3-8
fuses .....	3-4

## G

“G” loads.....	6-2
gearboxes .....	4-5
glide.....	6-8
glide ratio .....	6-1, 6-8
gliding .....	2-3, 11-9
go-around.....	11-8
go or no-go decision.....	7-3
GPS .....	3-4, 8-7
grass surface.....	10-1
gravity moment .....	2-10
gross weight .....	5-3, 7-8
ground adjustable-pitch propeller .....	4-6
ground adjustable propeller.....	3-9
ground effect .....	2-9
ground reference maneuvers .....	9-1
groundspeed .....	9-3

ground steering.....	3-2, 5-11
ground track.....	9-1, 9-2
ground training.....	1-3

## H

hard landing.....	11-13
hazardous attitude antidotes.....	1-4
heart attack.....	1-8
high final approach.....	11-11
high roundout.....	11-11
history.....	1-1
human factors.....	1-4
hyperventilation.....	1-7
hypoxia.....	1-7

## I

I'M SAFE.....	1-9
ignition switches.....	3-3
ignition system.....	4-9
in-flight fire.....	12-7
incidents.....	7-1
indicators.....	5-12
induced drag.....	2-6
induction system.....	4-6
inflation.....	7-4
initial climb.....	7-5, 7-7
inner ear.....	1-7
inside pattern.....	10-1
instrument panel.....	3-3
instruments.....	3-3

## J

Jalbert, Domina C.....	1-1
------------------------	-----

## K

kiting.....	5-10, 5-11, 7-3, 7-6
-------------	----------------------

## L

landing.....	3-5
landing point.....	11-1
landing porpoise.....	12-7
landing zone.....	12-6
lateral axis.....	2-9
leading edge.....	2-1
left-turning tendency.....	2-15, 3-7
level turns.....	6-5
lift.....	2-5
lift-off.....	7-1, 7-5, 7-7
lift to drag.....	6-8
light-sport aircraft.....	1-2, 1-4
line-overs.....	5-13, 5-16, 7-4
lines restricted during takeoff roll.....	12-3
line twists.....	5-15
liquid-cooled engine.....	3-3
liquid cooling systems.....	4-13
load factor.....	2-15

LOC.....	7-4
lock-out.....	7-6
logbook.....	4-1
logbook endorsement.....	1-3
logbooks.....	1-2, 5-5
longitudinal axis.....	2-1, 2-9
lost procedures.....	12-1
low final approach.....	11-11
LSA.....	1-2

## M

magneto.....	4-9
maintenance.....	4-1
manufacturers' recommended minimums.....	7-3
master switch.....	3-4
mechanical rotary valves.....	4-1
medical certificate.....	1-3, 5-5
medical factors.....	1-5
medium turns.....	6-6
military operation areas (MOA).....	8-5
military training routes (MTR).....	8-5
mindset.....	1-4
mixture control.....	4-8
moment.....	2-9
motion sickness.....	1-7
multi-cell wing.....	1-1

## N

N-number.....	1-2
national security areas.....	8-6
Nicolaides.....	1-1
night operations.....	12-1
noise abatement.....	7-9
normal approach and landing.....	11-1
normal takeoff.....	7-5
NOTAMs.....	1-4, 5-1, 8-5

## O

oil.....	5-8
oil/fuel mixing.....	4-13
oil mixing.....	4-1
oil system.....	4-13
one-way pressure valves.....	4-1
oscillations.....	12-7, 12-8
over-water flight.....	12-6

## P

P-factor.....	2-11
packing the wing.....	5-17
parachute-wing stall.....	12-3
parachute.....	1-1, 1-2
parachute (PPC).....	1-1
parachute jump.....	1-1
parachute jump areas.....	8-5
parafoil.....	1-1
parallel operations.....	10-6

parasite drag .....	2-6	ram-air wing.....	2-3
parking .....	5-17	rate of turn.....	9-4
part 61 .....	1-3	reciprocating engines .....	4-1
passenger briefing .....	7-2	rectangular course .....	9-4
pattern altitude .....	10-4	rectangular shape .....	2-2
PAVE.....	5-1	reduction drives.....	3-8
pendulum.....	1-2	reed valve .....	4-1
pendulum effect.....	2-9, 6-1, 6-2	reference line.....	9-4
pendulum stability.....	2-10	refueling .....	4-12
personality tendencies.....	1-4	rejected landings .....	11-8
personal minimums .....	5-1, 5-3	rejected takeoff.....	7-7
photo identification .....	5-5	relative wind.....	2-1, 9-3
Pilot's Operating Handbook.....	1-2, 3-2	resource management.....	1-4
pilotage.....	8-7	restricted areas .....	8-4
pilot certificate .....	1-2, 5-5	right-of-way .....	10-5
pilot error .....	1-4	risers.....	3-5, 3-7
pilot induced oscillation.....	6-6	risk management.....	1-4, 11-9
piston porting .....	4-1	roll-over.....	12-4
piston seizure .....	4-5	roll axis.....	2-1
pitch.....	2-9, 6-1	rolling preflight .....	7-4
pitch angle.....	2-1	rollover .....	7-2
planform.....	2-2	rotation .....	7-1, 7-5
POH.....	1-2, 3-2	roundout.....	11-3
poppet valves.....	4-1	run-up.....	5-10
porpoising .....	2-14, 12-7	runway.....	5-17, 11-6
positioning the cart.....	7-6	runway gradient .....	7-8
position lights.....	12-1	runway incursion prevention.....	3-2
postflight .....	5-17	runway slope .....	7-8
powered parachute .....	1-2	runway surfaces.....	7-8
powered parachute rating.....	1-2		
power loss .....	7-7	<b>S</b>	
powerplant.....	4-1	S-turn across a road.....	9-6
PPC .....	1-2	safety belt.....	7-2
PPCL.....	1-2	scan .....	3-3
PPCS .....	1-2	scanning .....	6-5, 8-7, 9-1
practical test .....	1-3	scavenging.....	4-4
Practical Test Standards .....	1-3	scuba diving .....	1-8
preflight.....	5-1, 5-2	search and rescue .....	12-9
preflight checklist.....	5-5	seatbelts.....	3-2
preflight inspection.....	5-1, 5-6, 12-1	seats.....	5-6, 7-2
pressure knots.....	7-4	sectional chart .....	8-7
primer.....	4-10	see and avoid.....	8-7, 10-1
private pilot .....	1-3	segmented circle.....	10-4, 10-5
private property .....	5-2	shallow turns .....	6-6
proficiency check .....	1-3	shoulder harness.....	7-2
prohibited areas.....	8-4	side-by-side configurations .....	3-1
propeller.....	3-8, 4-6, 5-8	signs .....	10-2
PTS.....	1-3	simulated emergency landing.....	11-9
pull-overs .....	5-11	single-pilot resource management .....	1-4
pulse-charging.....	4-4	situational awareness.....	1-4, 1-5, 12-2
pump systems.....	4-10	skidding.....	2-9
pusher configuration.....	5-9	solo .....	1-3
<b>R</b>		spatial disorientation .....	1-8
radar facilities.....	10-2	special use airspace .....	8-4
radio communications.....	5-11	speed .....	2-12, 2-15, 6-1
radios.....	3-4	sport jumping .....	1-1
		sport pilot .....	1-3

sport pilot instructor .....	1-4
spring valve .....	4-1
SRM .....	1-4
stability .....	2-12
stabilized approach .....	11-7
stalls .....	2-12, 2-14
standard airport traffic pattern .....	10-2
starter system .....	4-13
steep turns .....	6-6
steering .....	6-1
steering bars .....	3-5
steering controls .....	6-1
storage .....	5-1
straight-and-level flight .....	6-3
stress .....	1-8
stress management .....	1-4, 1-5
strobe lighting .....	3-4
stroke .....	1-8
sump collector .....	4-11
sump drain valve .....	3-8
sunset .....	12-1
suspension lines .....	3-6, 5-12
suspension system .....	3-9

**T**

takeoff distance .....	7-8
takeoff performance .....	7-8
takeoff preflight roll .....	12-4
takeoff roll .....	7-1, 7-4, 7-5, 7-7
tandem configuration .....	3-1
taxiing .....	3-1, 5-10
temporary flight restriction (TFR) .....	5-1, 8-5
terminal Radar Service Areas (TRSA) .....	8-6
The Irish Flyer .....	1-1
throttle .....	3-2, 3-8, 6-1, 11-2
thrust .....	2-5, 2-7
thrust line moments .....	2-10
tight pattern .....	10-1
tires .....	3-9
torque .....	2-15, 7-5
touchdown .....	11-5
traffic indicators .....	10-3
traffic patterns .....	10-1
trailerling .....	5-1
trailing edge .....	2-1
transponders .....	3-4
tricycle gear configuration .....	3-2
trim angle .....	2-1
trim lock .....	6-8
tuned exhaust systems .....	4-4
turbulence .....	5-4
turbulent air approach and landing .....	11-9
turn .....	3-5, 5-11
turning .....	2-9, 6-2
turns .....	6-6
turns around a point .....	9-8
twists .....	5-12, 5-13

two-stroke engines .....	4-1
--------------------------	-----

## U

ultralight vehicles .....	1-1
uncontrolled airspace .....	8-4, 8-6
upwind leg .....	10-5

## V

valve systems .....	4-1
vertical axis .....	2-9
vertigo .....	1-8
VFR routes .....	8-6
visibility .....	5-3
visual inspection .....	5-6
V lines .....	3-7
voltage meter .....	3-5
voltage regulator .....	3-5

## W

walk around .....	5-6
warm-up .....	5-10
warning areas .....	8-4
weather .....	5-3
weather briefing .....	5-3
weather information .....	1-4
weight .....	2-5, 2-7
weight and loading .....	5-3
wheels .....	3-9
wind .....	5-3, 5-12, 7-5, 7-8, 12-2
wind drift .....	9-3
wind drift correction .....	9-1
wind indicators .....	10-3
wing .....	1-2, 3-5
wing attachment .....	2-10
wing attachment point .....	2-10
wing attachment systems: center of gravity adjustment tubes .....	3-2
wing bag .....	5-12
wing blowing over .....	11-13
wing collapses .....	2-12
wing inflation .....	7-3, 7-6
wing inspection .....	5-12, 7-1
wing layout .....	5-13, 7-1
accordion method .....	7-2
inverted method .....	7-1
stacked method .....	7-2
wing loading .....	2-3
wing lock-out .....	7-4, 12-3
wing not centered overhead .....	12-4
wing oscillations .....	7-4
wing trim .....	6-8
wing wall .....	12-3

## Y

yaw .....	2-9
-----------	-----



